

FROM BELGIUM WITH LOVE

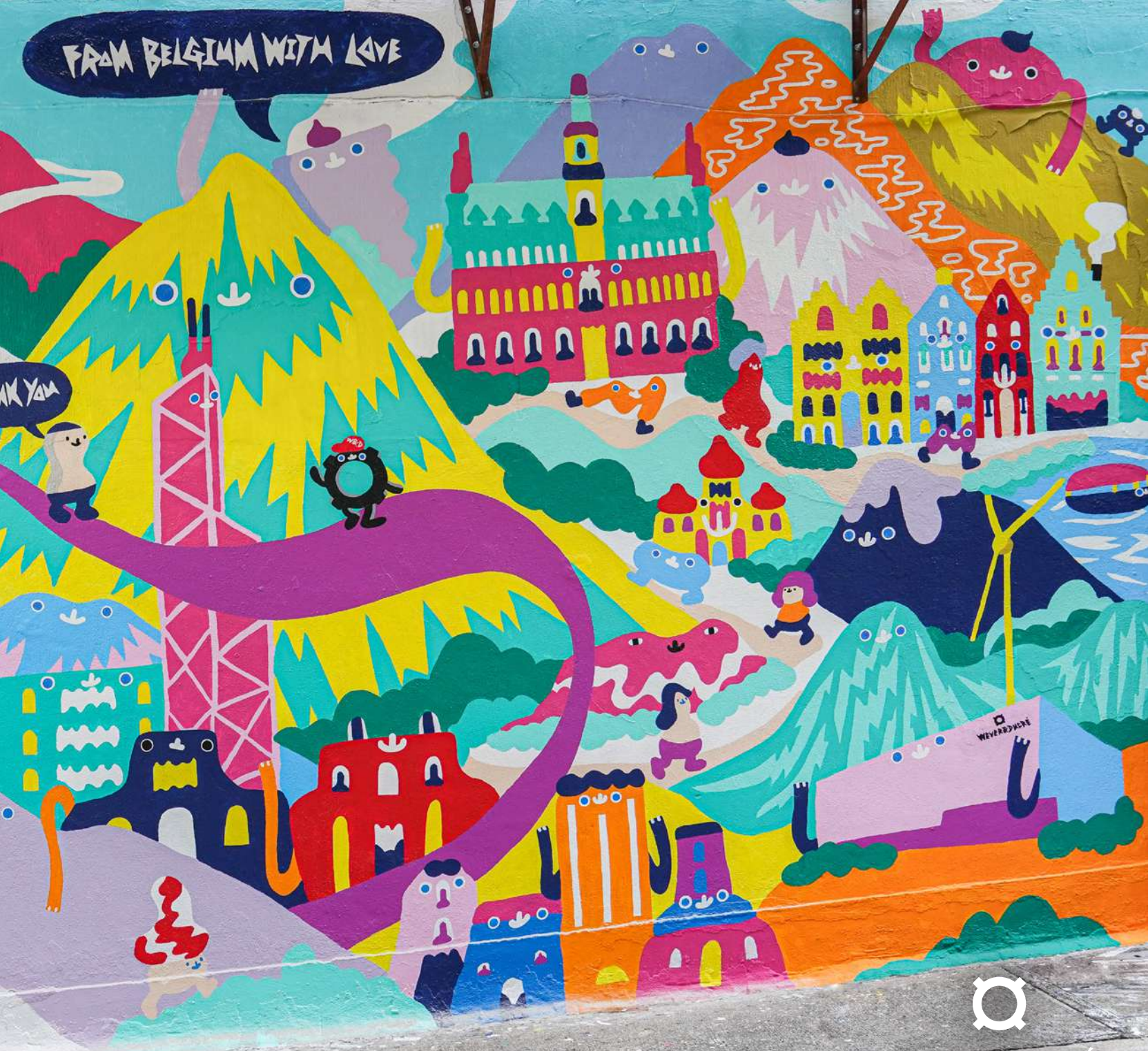

WEVER & DUCRÉ  
LIGHTING



It's a mild November day in the middle of Hong Kong, where Zoie Lam is working on one of her brightly coloured murals. The street artist grew up in the vibrant metropolis and is bringing a slice of Belgian joie de vivre to the city for Wever & Ducré. "From Belgium with love" is the message that Zoie illustrates in her intense, colourful style. The result is a fictional world of Belgian and local architecture that fits perfectly into her ZLISM universe. "I just want people to feel good when they see my mural", says Zoie and lets us feel this positive energy with every brushstroke.

Es ist ein lauer Novembertag inmitten von Hongkong, wo Zoie Lam gerade an einem ihrer leuchtend-bunten Murals arbeitet. Die Street-Art-Künstlerin ist in der pulsierenden Metropole groß geworden und holt für Wever & Ducré ein Stückchen belgischer Lebensfreude in die Stadt. „From Belgium with love“ lautet die Botschaft, die Zoie in ihrem dichten, farbenfrohen Stil illustriert. So entsteht eine fiktive Welt aus belgischer und lokaler Architektur, die perfekt in ihr ZLISM-Universum passt. „Die Menschen sollen sich einfach gut fühlen, wenn sie mein Mural sehen“, meint Zoie und lässt uns diese positive Energie mit jedem Pinselstrich spüren.

**THE MESSAGE IS LOVE**

## Beam us up, Zoie

### WELCOME TO PLANET ZLISM

A small, brightly coloured planet where only good people live – that is Zoie Lam's vision of a different, better society. And the Hong Kong-born artist paints it on the wall in bright colours. She calls this extraordinary place ZLISM, a dense maze of streets and houses in which the inhabitants constantly experience new adventures. Zoie continues these stories in each work, spreading her own personal message of love, respect, and joie de vivre. Where does the name ZLISM come from? It is made up of her initials "ZL" and "LISM", and stands for the artist's very own, positive philosophy.

Ein kleiner knallbunter Planet, auf dem nur gute Menschen leben, das ist Zoie Lams Vision einer anderen, besseren Gesellschaft. Und die malt die aus Hongkong stammende Künstlerin in leuchtenden Farben an die Wand. ZLISM nennt sie diesen außergewöhnlichen Ort, der aus einem dichten Gewirr von Straßen und Häusern besteht, in dem die Bewohner immer neue Abenteuer erleben. Woher der Name ZLISM kommt? Er setzt sich aus ihren Initialen „ZL“ und „LISM“ zusammen und steht für die ganz eigene positive Philosophie der Künstlerin.



**HAVE A LOOK AT OUR LIMITED ARTIST EDITION**

[weverducre.com/artist-edition24](http://weverducre.com/artist-edition24)



## CEILING RECESSED





























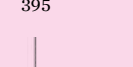
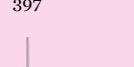





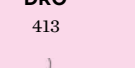
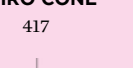
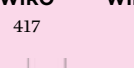
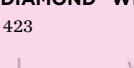
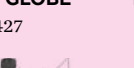



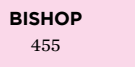



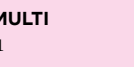

52 – 159

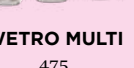
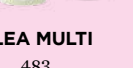
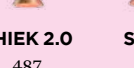
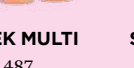
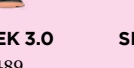
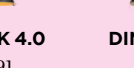
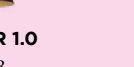



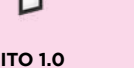
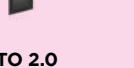























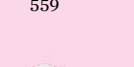
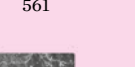
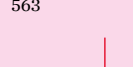





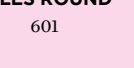
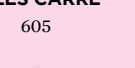
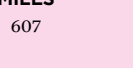
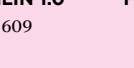
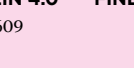
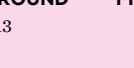



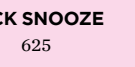

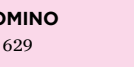
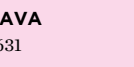
						<b>DEEP ADJUST</b>							
<b>MATCH POINT</b> 57	<b>DEEP POINT</b> 59	<b>DEEP BIJOU</b> 61	<b>DEEP PETIT</b> 63	<b>DEEP</b> 65	<b>DEEPER</b> 67	<b>PETIT</b> 69	<b>DEEP ADJUST</b> 71						
<b>DEEP ADJUST TRIMLESS</b> 75	<b>DEEP ADJUST ASYM</b> 77	<b>DEEP ADJUST FORT</b> 79	<b>SPINEO</b> 81	<b>RONY POINT</b> 83	<b>RONY</b> 85	<b>RON</b> 87	<b>PIRRO PETIT</b> 91	<b>PIRRO</b> 93					
		<b>STRANGE PETIT TRIMLESS</b>											
<b>PLANO PETIT</b> 97	<b>PLANO</b> 99	<b>STRANGE PETIT TRIMLESS</b> 101		<b>STRANGE TRIMLESS</b> 103	<b>SNEAK</b> 105	<b>SNEAK TRIMLESS</b> 107	<b>LECA</b> 109	<b>MATCH</b> 113	<b>MATCH STICK</b> 117				
<b>CENO</b> 119	<b>BLIEK PETIT TRIMLESS</b> 123	<b>BLIEK PETIT</b> 123	<b>BLIEK ROUND</b> 127	<b>BLIEK SQUARE</b> 129	<b>RUVI</b> 131	<b>DEEP POINT IP44</b> 135	<b>DEEP BIJOU IP65</b> 137	<b>DEEP PETIT IP65</b> 139					
		<b>MATCH POINT IP44</b>											
<b>DEEP IP65   IP44</b> 141	<b>DEEPER IP44</b> 143	<b>MATCH POINT IP44</b> 145		<b>TAIO IP65</b> 147	<b>RINI SNEAK IP44</b> 149	<b>LUNA ROUND IP44</b> 151	<b>LUNA SQUARE IP44</b> 151	<b>PLANO IP44</b> 153	<b>PERLEZ IP44</b> 155				
			<b>CEILING SURFACE</b>										
<b>MIRBI IP44 1.0</b> 157	<b>MIRBI IP44 2.0</b> 157	<b>CITY IP44</b> 159	<b>CEILING SURFACE</b> 160 – 289						<b>BOX MINI</b> 165	<b>BOX</b> 169	<b>DOCUS MINI</b> 173	<b>DOCUS</b> 175	<b>HEXO MINI</b> 179
<b>HEXO</b> 181	<b>RAY MINI</b> 185	<b>RAY</b> 189	<b>SOLID BIJOU</b> 193	<b>SOLID PETIT</b> 195	<b>SOLID</b> 197	<b>TRACE</b> 201	<b>PIRRO PETIT</b> 203	<b>PIRRO SPOT</b> 205					

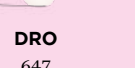
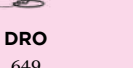
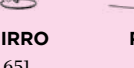



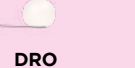

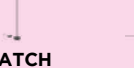















































<b>PIRRO OPAL</b> 211	<b>PLANO PETIT</b> 213	<b>PLANO</b> 215	<b>SIRRO</b> 217	<b>LECA</b> 221	<b>MATCH</b> 223	<b>CENO</b> 227	<b>BLIEK PETIT</b> 235	<b>MICK</b> 237			
<b>SARA ON BASE</b> 241	<b>SQUBE ON BASE</b> 243	<b>FIL SPIN</b> 251	<b>TRACE SPIN</b> 253	<b>PERLEZ SPIN</b> 255	<b>TRACE GRID</b> 257	<b>PERLEZ GRID</b> 259	<b>VENN</b> 261	<b>DRO</b> 263			
<b>WIRO</b> 265	<b>MIRRO</b> 267	<b>CLEA</b> 271	<b>J.J.W.</b> 273	<b>ROOMOR OFFICE</b> 275	<b>FINLIN</b> 277	<b>PERLEZ IP44</b> 279	<b>TAIO IP65</b> 281	<b>MIRBI IP44 1.0</b> 283			
				<b>STREX TRACKS</b>							
<b>MIRBI IP44 2.0</b> 283	<b>ROB IP44</b> 285	<b>ROBY IP44</b> 287	<b>TOWNA IP44</b> 289	<b>STREX TRACKS</b> 290 – 329				<b>48V TRACKS</b> 295	<b>CENO</b> 303	<b>MATCH</b> 307	<b>MICK</b> 309
<b>BOX</b> 311	<b>DOCUS</b> 313	<b>HEXO</b> 315	<b>RAY</b> 317	<b>DOT LIGHT MODULE</b> 319	<b>OPAL LIGHT MODULE</b> 319	<b>MATCH</b> 321	<b>ODREY</b> 323	<b>SOLLI</b> 329			
<b>1-PHASE TRACKS</b>											
<b>1-PHASE TRACKS</b> 330 – 347				<b>SARA</b> 333	<b>SQUBE</b> 337	<b>PIRRO</b> 339	<b>DRO</b> 341	<b>HEXO</b> 343	<b>RAY</b> 343	<b>ODREY</b> 345	
<b>3-PHASE TRACKS</b>									<b>MORE ON THE NEXT PAGE</b>		
<b>3-PHASE TRACKS</b> 348 – 357				<b>SQUBE</b> 351	<b>CENO FORT</b> 353	<b>HEXO</b> 355	<b>RAY</b> 355	<b>ROOMOR OFFICE</b> 357	<b>MORE ON THE NEXT PAGE</b>		

# Indoor

# Indoor

<b>SYSTEMS</b> 358 – 369		 <b>PIRRO SYSTEM</b> 361	 <b>ELLO SYSTEM</b> 362	 <b>ILANE</b> 367	<b>CEILING SUSPENDED</b> 370 – 495				 <b>TRACE CHANDELIER</b> 373	 <b>NET</b> 377	 <b>FINELLE</b> 381	 <b>FIL</b> 383							
 <b>FINLIN</b> 385	 <b>KUJO</b> 387	 <b>DARF</b> 391	 <b>ELLO</b> 395	 <b>GIGANT</b> 397	 <b>TRACE 1.1</b> 399	 <b>TRACE 2.0</b> 401	 <b>CONE</b> 403	 <b>CORK</b> 405	 <b>MATCH</b> 407	 <b>SOLLI</b> 409	 <b>DRO</b> 413	 <b>WIRO CONE</b> 417	 <b>WIRO</b> 417	 <b>WIRO DIAMOND</b> 423	 <b>WIRO GLOBE</b> 427	 <b>MIRRO</b> 431	 <b>J.J.W.</b> 437		
 <b>ROOMOR</b> 445	 <b>ROOMOR OFFICE</b> 451	 <b>BISHOP</b> 455	 <b>ODREY</b> 461	 <b>ODREY MULTI</b> 461	 <b>RAY</b> 469	 <b>RAY MULTI</b> 469	 <b>HEXO</b> 471	 <b>HEXO MULTI</b> 471	 <b>WETRO</b> 475	 <b>WETRO MULTI</b> 475	 <b>CLEA</b> 483	 <b>CLEA MULTI</b> 483	 <b>SHIEK 2.0</b> 487	 <b>SHIEK MULTI</b> 487	 <b>SHIEK 3.0</b> 489	 <b>SHIEK 4.0</b> 491	 <b>DINOR 1.0</b> 493		
 <b>DINOR 2.0</b> 493	 <b>DINOR 3.0</b> 493	<b>WALL RECESSED</b> 497 – 509		 <b>RETO</b> 499	 <b>LITO 1.0</b> 501	 <b>LITO 2.0</b> 501	 <b>STRIPE</b> 503	 <b>STRANGE TRIMLESS</b> 505	 <b>THEMIS</b> 507	 <b>ORIS</b> 509	<b>WALL SURFACE</b> 510 – 643		 <b>CENO</b> 513	 <b>MATCH</b> 515	 <b>TRACE</b> 517	 <b>TRACE SLIM</b> 521	 <b>ODREY</b> 525	 <b>BOX MINI</b> 533	 <b>BOX</b> 535

 <b>DOCUS MINI</b> 539	 <b>HEXO MINI</b> 541	 <b>RAY MINI</b> 543	 <b>RAY</b> 545	 <b>TRAIN</b> 549	 <b>CENTRAL</b> 551	 <b>LEENS</b> 553	 <b>BENTO</b> 555	 <b>DRO</b> 557	 <b>DARF</b> 559	 <b>ROOMOR 1.1</b> 561	 <b>ROOMOR 3.1</b> 563	 <b>WIRO</b> 569	 <b>CLEA</b> 571	 <b>J.J.W.</b> 573	 <b>MIRRO</b> 581	 <b>DOT</b> 587	 <b>TAPIS</b> 591
 <b>MILES ROUND</b> 601	 <b>MILES CARRÉ</b> 605	 <b>MILES</b> 607	 <b>FINLIN 1.0</b> 609	 <b>FINLIN 4.0</b> 609	 <b>FINLIN ROUND</b> 613	 <b>FIL SPIN</b> 615	 <b>VENN</b> 617	 <b>SARA SNOOZE</b> 621	 <b>MATCH SNOOZE</b> 623	 <b>MICK SNOOZE</b> 625	 <b>MICK WALL</b> 627	 <b>DOMINO</b> 629	 <b>SCAVA</b> 631	 <b>PERLEZ IP44</b> 635	 <b>RUVI IP44</b> 639	 <b>MIRBA IP44</b> 641	 <b>MIRBI LONG IP44</b> 643
<b>TABLE</b> 645 – 655		 <b>DRO</b> 647	 <b>DRO</b> 649	 <b>MIRRO</b> 651	 <b>ROOMOR</b> 653	 <b>REVER</b> 655											
<b>FLOOR</b> 656 – 665		 <b>DRO</b> 647	 <b>FINLIN</b> 657	 <b>MATCH</b> 659	 <b>DRO</b> 661	 <b>MIRRO</b> 663	 <b>ROOMOR</b> 665										
<b>SOFT ACOUSTICS</b>		 <b>MIRRO SOFT</b> 269	 <b>MIRRO SOFT</b> 433	 <b>SOLLI COCOON</b> 411	 <b>MIRRO SOFT</b> 585	 <b>TAPIS SOFT</b> 597											

<b>CEILING RECESSED</b> 669 – 679						<b>CEILING SURFACE</b> 681 – 699		
	<b>DEEP BIJOU IP65</b> 671	<b>DEEP PETIT IP65</b> 673	<b>DEEP IP65</b> 675	<b>TAIO IP65</b> 677	<b>INTRA</b> 679		<b>TRAM</b> 683	<b>TUBE</b> 685
								
<b>TAIO</b> 687	<b>RAY</b> 689	<b>TRAIN</b> 691	<b>TUBE CARRÉ</b> 693	<b>BOX</b> 695	<b>BLAS 1.0</b> 697	<b>BLAS 2.0</b> 697	<b>ROB</b> 699	
<b>WALL RECESSED</b> 701 – 709			<b>WALL SURFACE</b> 710 – 747					
	<b>RETO</b> 703	<b>ORIS</b> 707		<b>TRAM</b> 713	<b>TUBE</b> 715	<b>TAIO</b> 719	<b>RAY</b> 721	<b>TRAIN</b> 723
								
<b>KIOSK</b> 725	<b>CENTRAL</b> 727	<b>TUBE CARRÉ</b> 729	<b>BOX</b> 733	<b>X-BEAM</b> 737	<b>RETO</b> 739	<b>PALOS</b> 741	<b>BLAS</b> 743	<b>TAPE</b> 745
	<b>FLOOR RECESSED</b> 749 – 763							
<b>SWAM</b> 747		<b>CARD 0.1</b> 751	<b>CARD 0.2</b> 751	<b>BLINK</b> 753	<b>MAP</b> 755	<b>MAP ASYM</b> 759	<b>CHART</b> 761	<b>CHART ASYM</b> 763
<b>FLOOR SURFACE</b> 764 – 803								
	<b>GEO</b> 769	<b>REED</b> 771	<b>POLA</b> 773	<b>KIOSK</b> 775	<b>SWAM</b> 777	<b>TAPE</b> 781	<b>STIPO</b> 783	<b>STAKE</b> 785
								
<b>STAKE FOLD</b> 785	<b>X-BEAM</b> 787	<b>GATE</b> 789	<b>PALOS ROUND</b> 791	<b>PALOS CARRÉ</b> 795	<b>LINUS</b> 799	<b>COSTA 1.0</b> 801	<b>COSTA 2.0</b> 803	



#### HOW TO PRONOUNCE IT RIGHT

Weferantdookray, that's how it sounds when Anna from Germany pronounces our Franco-Flemish name. But how do our other colleagues say it? Find out in our "Say-our-name" challenge which shows how differently "Wever & Ducré" is pronounced around the world. Of course, you'll also find out how it's pronounced correctly.

Weferantdükreeh, so klingt's, wenn Anna aus Deutschland unseren französisch-flämischen Namen ausspricht. Doch wie machen's die anderen Kollegen? Das verrät Ihnen unsere „Say-our-name“-Challenge, die zeigt, wie unterschiedlich Wever & Ducré rund um den Erdball ausgesprochen wird. Wie's richtig gemacht wird, erfahren Sie dabei natürlich auch.



[weverducre.com/pronunciation](https://weverducre.com/pronunciation)

## Welcome to our *world*

We all know it, the famous glimpse at the ceiling during which you think: "Well, everyone really does have that light." That's why we strive to achieve lighting solutions that first and foremost fit the description: unique. Who inspires us in the process? People like you, who share our enthusiasm for beautiful things and attach as much importance to noble design as to high-quality workmanship. Does it sound passionate? Well, that's what it is. After all, life is simply far too short for boring lighting.

Wir kennen ihn alle, den berühmten Blick an die Decke, bei dem man sich denkt: „Also die Leuchte hat wirklich jeder“. Deshalb kämpfen wir für Lichtlösungen, die vor allem eines sind: einzigartig. Von wem wir uns dabei inspirieren lassen? Von Menschen wie Ihnen, die unsere Begeisterung für schöne Dinge teilen und auf edles Design ebenso viel Wert legen wie auf eine hochwertige Verarbeitung. Klingt leidenschaftlich? Ist es auch. Denn für langweilige Leuchten ist das Leben einfach viel zu kurz.



Exciting Belgian *design lighting* for everyone, delivered fast.

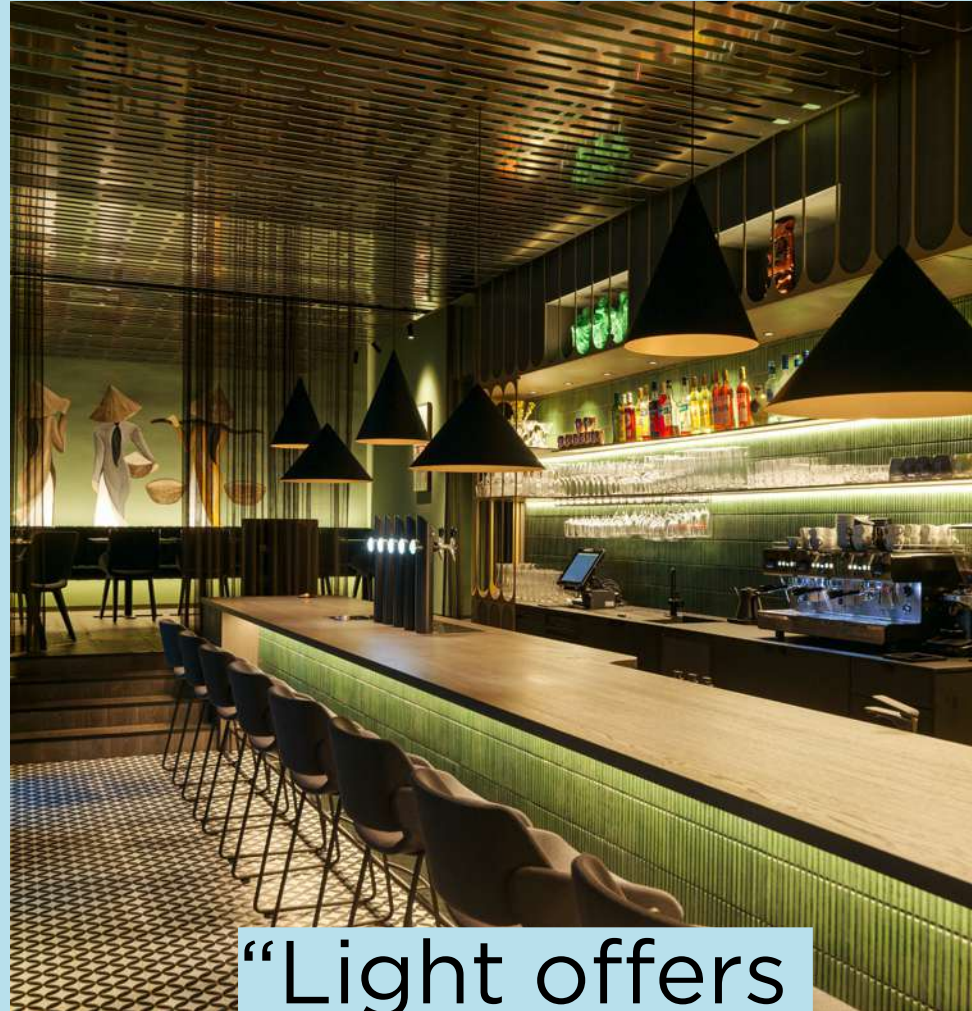

“Light offers  
*endless possibilities*  
to architects.”

CLEMENS HAMMER *Product Manager*

#### MAKES YOUR HEART BEAT FASTER

Don't worry, this can easily happen with our unusual designs. After all, we love to surprise you with new shapes, colours, and materials and create lights that are so much more than a simple light source. How do we achieve this? With many exciting collaborations and a team of international architects, artists, and in-house designers who make each of our lights truly unique.

Keine Sorge, das kann bei unseren außergewöhnlichen Designs schnell mal passieren. Schließlich lieben wir es, Sie mit neuen Formen, Farben und Materialien zu überraschen und Leuchten zu kreieren, die so viel mehr sind als eine simple Lichtquelle. Wie wir das hinbekommen? Mit vielen spannenden Kooperationen und einem Team aus internationalen Architekten, Künstlern und Inhouse-Designern, das jede unserer Leuchten zu einem echten Unikat macht.



## Exciting Belgian *design lighting*



#### JUST WHAT YOU'VE BEEN LOOKING FOR

Whether you want to set creative accents or design entire interiors in a uniform design language – anything is possible thanks to our modern LED lights. And it's super easy. After all, their shape, colour, and size can be adapted to your needs and their installation options are incredibly versatile.

Egal, ob Sie kreative Akzente setzen oder ganze Interieurs in einer einheitlichen Designsprache gestalten möchten – mit unseren modernen LED-Leuchten ist alles möglich. Und das super-easy. Schließlich passen sie sich in Form, Farbe und Größe ganz an Ihre Bedürfnisse an und zeigen sich auch in Sachen Montage absolut flexibel.

## READY FOR AN ONLINE DATE

Well, that's the way it is with our lights: Once you've fallen in love with a design, you naturally want to have it with you immediately. The good news is that we dispatch all products within just 48 hours. So simply check your favourite design's availability online. In the meantime, you can already put the champagne on ice.

Tja, so ist das mit unseren Leuchten: Hat man sich erst mal in ein Design verliebt, will man es natürlich sofort bei sich haben. Die gute Nachricht: Wir versenden alle Produkte innerhalb von nur 48 Stunden. Checken Sie die Verfügbarkeit Ihres Lieblings also einfach online. Den Champagner können Sie in der Zwischenzeit ja schon mal kaltstellen.



[weverducre.com/products](https://weverducre.com/products)

IT'S ALL SYSTEMS GO IN 48 HOURS

# For everyone, delivered fast

We love beautiful design because of its unusual shape, its special materials, and because it makes our lives easier. That's why we make sure our products are intuitive to use, easy to install, and simple to maintain right from the development stage. Even if you don't have a great deal of technical knowledge. So don't worry about complicated instructions and incomprehensible installation plans – our smart LED technology makes everything run smoothly. Whether in a cosy micro-apartment or the hippest club in town.

Wir lieben schönes Design nicht nur wegen seiner außergewöhnlichen Form oder der besonderen Materialien, sondern auch, weil es unser Leben leichter macht. Deshalb achten wir schon bei der Entwicklung unserer Produkte darauf, dass sie sich intuitiv bedienen, einfach montieren und problemlos warten lassen. Und das auch, wenn man über kein großes technisches Wissen verfügt. Also keine Angst vor komplizierten Anleitungen und unverständlichen Montageplänen – mit unserer smarten LED-Technik läuft alles ganz entspannt. Ob im kuscheligen Micro-Apartment oder im hippestem Club der Stadt.

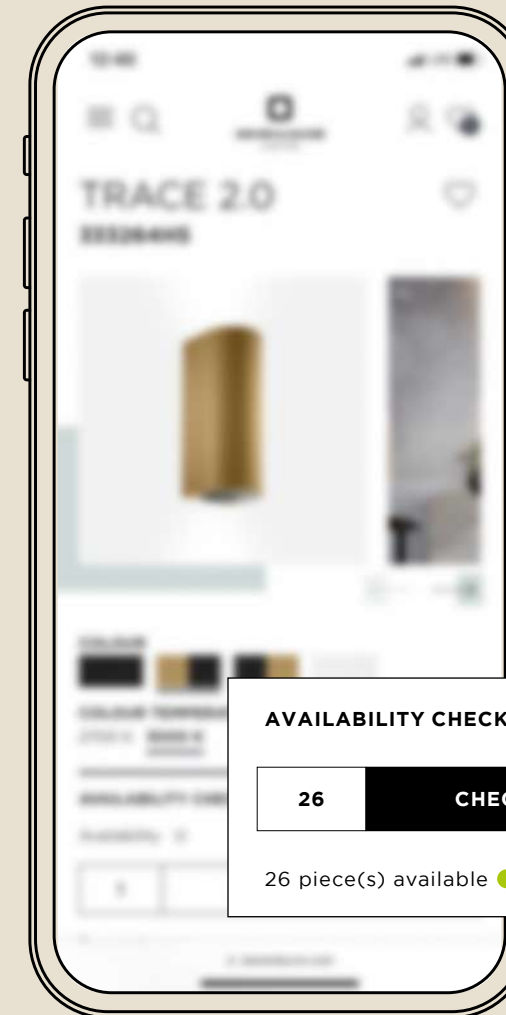

### AVAILABILITY CHECK

26

CHECK AVAILABILITY

26 piece(s) available ●





It's not all about *chocolate.*



It's true: The smell of fresh waffles and sweet chocolate wafts around your nose on almost every corner in Belgium. But the enthusiasm for cool design is also in the air here. That's why there's no better place for us to be inspired by new colours, shapes, and materials. Preferably with a crispy waffle in our hands.

Es stimmt schon: Der Duft von frischen Waffeln und süßer Schokolade weht einem in Belgien an fast jeder Ecke um die Nase. Aber auch die Begeisterung für ausgefallenes Design liegt hier förmlich in der Luft. Deshalb gibt es für uns keinen schöneren Ort, um sich von neuen Farben, Formen und Materialien inspirieren zu lassen. Am besten mit einer knusprigen Waffel in der Hand.



[weverdudre.com/about](https://weverdudre.com/about)

OUR HERITAGE STORY

## From *Belgium* with love

Every story has to have a beginning. Ours begins in the early eighties, when a handful of young Belgians decide to start a new lighting company. So far, so good. Yet what name should the company be given? Since several official languages are spoken in Belgium – including Flemish and French – there was only one choice: The name would need to be equally at home in both worlds, phonetically. Then, by chance, a document fell into the hands of the company's founders: a little guide to a successful life. His advice: hard work (“WERklust”), trust (“VERtrouwen”), and enthusiasm (“ENthousiasme”), but also courage (“Durf”) and a good dose of creativity (“CREativiteit”). Today, these five points still constitute our company philosophy.

Jede Geschichte braucht einen Anfang. Unsere beginnt in den frühen Achtzigern, als eine Handvoll junger Belgier beschließt, eine neue Leuchtenfirma zu gründen. So weit, so gut. Doch welchen Namen sollte das Unternehmen bekommen? Da in Belgien mehrere Amtssprachen – darunter Flämisch und Französisch – gesprochen werden, blieb nur eine Möglichkeit: Der Name musste phonetisch in beiden Welten zuhause sein. Da fiel den Firmengründern zufällig ein Schriftstück in die Hände: ein kleiner Leitfaden für ein erfolgreiches Leben. Sein Rat: harte Arbeit (WERklust), Vertrauen (VERtrouwen), Begeisterung (ENthousiasme), gepaart mit Mut (Durf) und einer gehörigen Portion Kreativität (CREativiteit). Diese fünf Punkte bilden bis heute unsere Firmenphilosophie.



**Austria**  
GRAZ | VIENNA

**Belgium**  
BRUSSELS | KORTRIJK

**Finland**  
HELSINKI

**France**  
LYON | PARIS

**Germany**  
COLOGNE | FRANKFURT AM MAIN  
STUTTGART

**Italy**  
VENEZIA

**The Netherlands**  
AMSTERDAM

**Norway**  
OSLO

**Poland**  
WARSAW

**Spain**  
BARCELONA

**Sweden**  
STOCKHOLM

**Switzerland**  
LUCERNE

**United Kingdom**  
LONDON

**China**  
HONG KONG

**India**  
DELHI

**UAE**  
DUBAI

# To all around the world

What makes Wever & Ducré luminaires so fantastic? Simply that they feel at home in 60 countries around the world. They shine just as comfortably in a London rooftop bar as in an ultra-modern high-rise apartment in Hong Kong. What is the secret of their success? Exceptional design and high-quality materials give each luminaire a personal appeal for everyone. Sound perfect? Then you will be delighted to learn not just about the super-fast delivery for our products but also about the plastic-free packaging for shipping we have been using for four years, even for the smallest screws. Just take a look to the left and select one of the various showrooms. Our new collection is ready and waiting for you.

Das Tolle an Wever & Ducré-Leuchten? Sie sind in 60 Ländern der Welt zuhause. Und fühlen sich in der Londoner Rooftop-Bar genauso wohl wie in einem trendigen City-Apartment in Hongkong. Ihr Erfolgsgeheimnis? Außergewöhnliches Design und hochwertige Materialien, die jede Leuchte zum ganz persönlichen Lieblingsstück machen. Klingt perfekt? Dann wird es Sie freuen, dass unsere Produkte nicht nur superschnell, sondern seit vier Jahren auch ganz ohne Plastikverpackung geliefert werden. Und das bis zur kleinsten Schraube. Also gleich einen Blick nach links werfen und sich einen der verschiedenen Showrooms aussuchen. Unsere neue Kollektion wartet schon auf Sie.

## READY TO PLAN YOUR TRIP?

Every trip has its own charm, especially when you combine it with a visit to one of our showrooms. It makes every trip special. With our showroom travel guides, the planning of your city trip is almost completed. In addition to the classic highlights, our guides include culinary and exciting tips from locals to make your city trip anything but boring.

Jede Reise hat ihren ganz besonderen Charme, vor allem wenn man einen Städtetrip mit einem Besuch in einem unserer Schauräume verbindet. Damit wird jede Reise zu etwas ganz Besonderem, neben den klassischen Highlights beinhalten unsere Travel-Guides kulinarische und spannende Geheimtipps, die Ihren City-Trip alles andere als langweilig machen.



[weverducre.com/travel-guides](https://weverducre.com/travel-guides)



[weverducre.com/locations](https://weverducre.com/locations)



“Making products with a long lifetime is part of our *sustainability concept*.”

JOHAN DE SMEDT *Managing Director*



WE ARE COMMITTED

## Sustainable by *function*

The key for us is to give you luminaires that still have a friendly glow even after many years of service. How do we do that? By ensuring product quality that meets the standards of the Ecodesign Directive and making spare parts available for a particularly long lifespan. So should you ever need to replace your LED engine, you can do so for 20 years without any problems. Sound like a fair deal? Then you will also be pleased to know that we give you a 5-year guarantee\* on every product and that your luminaire comes to you in 100% plastic-free packaging.

Das Wichtigste für uns sind Leuchten, die Ihnen auch nach vielen Jahren noch freundlich entgegenstrahlen. Wie wir das hinbekommen? Mit einer Produktqualität, die den Standards der Ökodesign-Richtlinie entspricht, und Ersatzteilen, die besonders lange verfügbar sind. Sollten Sie Ihre LED-Engine also einmal austauschen müssen, ist das 20 Jahre lang problemlos möglich. Klingt nach einem fairen Deal? Dann wird es Sie auch freuen, dass wir Ihnen auf jedes Produkt 5 Jahre Garantie\* gewähren und Ihre Leuchte in einer 100% plastikfreien Verpackung zu Ihnen kommt.



[weverducre.com/sustainability](https://weverducre.com/sustainability)

\*The applicable conditions of guarantee are available to view at [weverducre.com](https://weverducre.com).  
Es gelten die auf [weverducre.com](https://weverducre.com) verfügbaren Garantiebedingungen.



COLOR  
NET  
WORK®

WE ARE COMMITTED

## Sustainable by colour

Can colour be more than just a passing trend? It can: At least according to COLORNETWORK®. The interior design collective specialises entirely in sustainable colours and materials. We loved this idea so much that we included it in our luminaire collections. Certain luminaires are exclusively available in the “Sustained Colors”, so they can therefore be combined particularly well with other products of this type of colour. Incidentally, this is equally true of our standard collection of luminaires, which also blend harmoniously into the colourful world of “Sustained Colors”.

Kann Farbe mehr sein als nur ein flüchtiger Trend? Sie kann. Zumindest wenn es nach dem Interieur-Kollektiv COLORNETWORK® geht, das sich ganz auf nachhaltige Farben und Materialien spezialisiert hat. Eine Idee, die wir so toll fanden, dass wir sie in unsere Leuchtenkollektionen aufgenommen haben. Manche Leuchten sind exklusiv in den „Sustained Colors“ erhältlich und lassen sich so besonders gut mit anderen Produkten dieses Farbtyps kombinieren. Das funktioniert übrigens auch mit den Leuchten unserer Standardkollektion, die sich harmonisch in die Farbwelt der „Sustained Colors“ einfügen.



[weverducre.com/sustainability-products](https://weverducre.com/sustainability-products)



“*Live simple!*: the sustainable choice, an elegant off-white colour that never goes out of style.”

KOBE JACXSENS *Sales Director*



First it was a bottle,  
now it *reduces noise*.



We go for a run with headphones, dance to loud electronic beats, and struggle to concentrate on a conversation with a customer in a crowded restaurant. In our modern world we are constantly surrounded by sound. It's no wonder that we sometimes long for silence. Especially when we want to withdraw, work undisturbed, or have important conversations. We prefer to do all this in rooms where we feel comfortable and which "sound" good to us. That's why pleasant acoustics are important in hotels, restaurants, and offices. They also play a major role in our well-being within our own four walls. What does this have to do with our lights? A lot. Because Wever & Ducré's new soft collection provides atmospheric light and beautiful design accents, and also better acoustics.

Wir gehen mit Kopfhörern laufen, tanzen zu lauten Electro-Beats und versuchen, uns im überfüllten Restaurant mühsam auf ein Kundengespräch zu konzentrieren. In unserer modernen Welt sind wir ständig von Geräuschen umgeben. Da ist es kein Wunder, dass wir uns manchmal nach der Stille sehnen. Vor allem, wenn wir uns zurückziehen, ungestört arbeiten oder wichtige Gespräche führen möchten. All das tun wir am liebsten in Räumen, in denen wir uns wohlfühlen. Und die für uns gut „klingen“. Deshalb ist eine angenehme Akustik nicht nur in Hotels, Restaurants oder Büros wichtig. Auch in den eigenen vier Wänden spielt sie für unser Wohlbefinden eine große Rolle. Was das mit unseren Leuchten zu tun hat? Viel. Denn die neue Wever & Ducré-Soft-Kollektion sorgt nicht nur für stimmungsvolles Licht und schöne Designakzente, sondern auch für eine bessere Akustik.

**SOFT ACOUSTICS**

## How soft can we get?



[weverducre.com/soft-acoustics](https://weverducre.com/soft-acoustics)



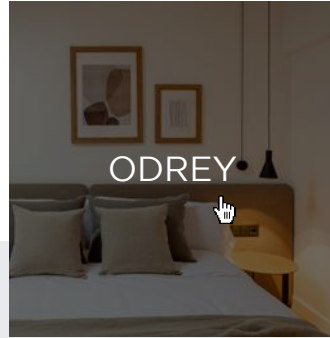

MORE PROJECT INSPIRATIONS ONLINE

# Projects to fall in *love* with



[weverducre.com/picture-gallery](https://weverducre.com/picture-gallery)



“*Lighting design* is the process of integrating light into the elements of architecture.”

SAM REYNAERT *Team Lead Lighting Design*

IT IS THE MEANS OF EXPRESSING THE DESIRED FUNCTIONAL AND AESTHETIC CHARACTER OF A SPACE

## The principles of *lighting design*

How we perceive a room and whether we feel comfortable in it depends strongly on the right lighting. The lighting mood, and thus the atmosphere of a room, should always be adapted to its function. So one of the most important questions is: What do I want to use it for? For working and playing, or rather for retreating and relaxing? Already decided? Perfect, then you can start planning. No idea where to start? Then simply click through our *Lightguide*, where we have summarised all the important basics for you.



[weverducre.com/basic-lightguide](https://weverducre.com/basic-lightguide)



Wie wir einen Raum empfinden und ob wir uns darin wohlfühlen, hängt auch von der richtigen Beleuchtung ab. Daher sollte man die Lichtstimmung und damit auch die Atmosphäre eines Raumes immer an seine Funktion anpassen. Eine der wichtigsten Fragen lautet also: Wofür möchte ich ihn nutzen? Zum Arbeiten und Spielen oder doch eher zum Zurückziehen und Entspannen? Ist dieser Punkt einmal geklärt, kann man eigentlich schon mit der detaillierten Planung loslegen. Noch keine Idee, womit Sie beginnen sollen? Dann klicken Sie sich einfach mal durch unseren *Lightguide*. Hier haben wir alle wichtigen Basics für Sie zusammengefasst.



### READY TO GET STARTED?

Light not only influences our mood, but also our perception. And this applies to every single room. That's why very distinct criteria are key when it comes to lighting the living room, bedroom, or dining room. Find out what these criteria are in our *Space Lightguide*.

Licht beeinflusst schließlich nicht nur unsere Stimmung, sondern auch unsere Wahrnehmung. Und das in jedem einzelnen Raum. Deshalb kommt es bei der Beleuchtung von Wohn-, Schlaf- oder Esszimmern auf ganz unterschiedliche Kriterien an. Und genau die möchten wir Ihnen mit unserem *Space Lightguide* verraten.



[weverducre.com/guide-spaces](https://weverducre.com/guide-spaces)

### HOW TO CREATE A LIGHTING PLAN

## Be your own *designer*

An old industrial loft with high ceilings and brick walls, or a modern new build with impressive, understated, minimalist elements? Wherever you choose to live is essential when planning your lighting. Therefore, completely different rules apply to existing buildings or buildings undergoing renovation than to a newly built home. So before you start planning the lighting, you should first analyse your home room by room. Our *Lightguide* helps you figure out what is important and which five steps you need to take to create your own personal lighting plan. Step-by-step and super easy.

Ein altes Industrie-Loft mit hohen Räumen und Backsteinwänden oder doch lieber ein moderner Neubau, der vor allem mit zurückgenommenen, minimalistischen Elementen überzeugt – wofür auch immer wir uns beim Wohnen entscheiden, ist auch für die Planung der Beleuchtung wesentlich. So gelten für existierende oder in Renovierung befindliche Gebäude ganz andere Regeln als bei einer Wohnung, die gerade neu gebaut wurde. Bevor es mit der Lichtplanung losgeht, sollten Sie Ihren Wohnbereich also erst einmal Raum für Raum analysieren. Worauf es dabei ankommt und mit welchen 5 Steps man zu seinem individuellen Lichtplan kommt, zeigen wir Ihnen in unserem *Lightguide*. Step-by-Step und supereasy.

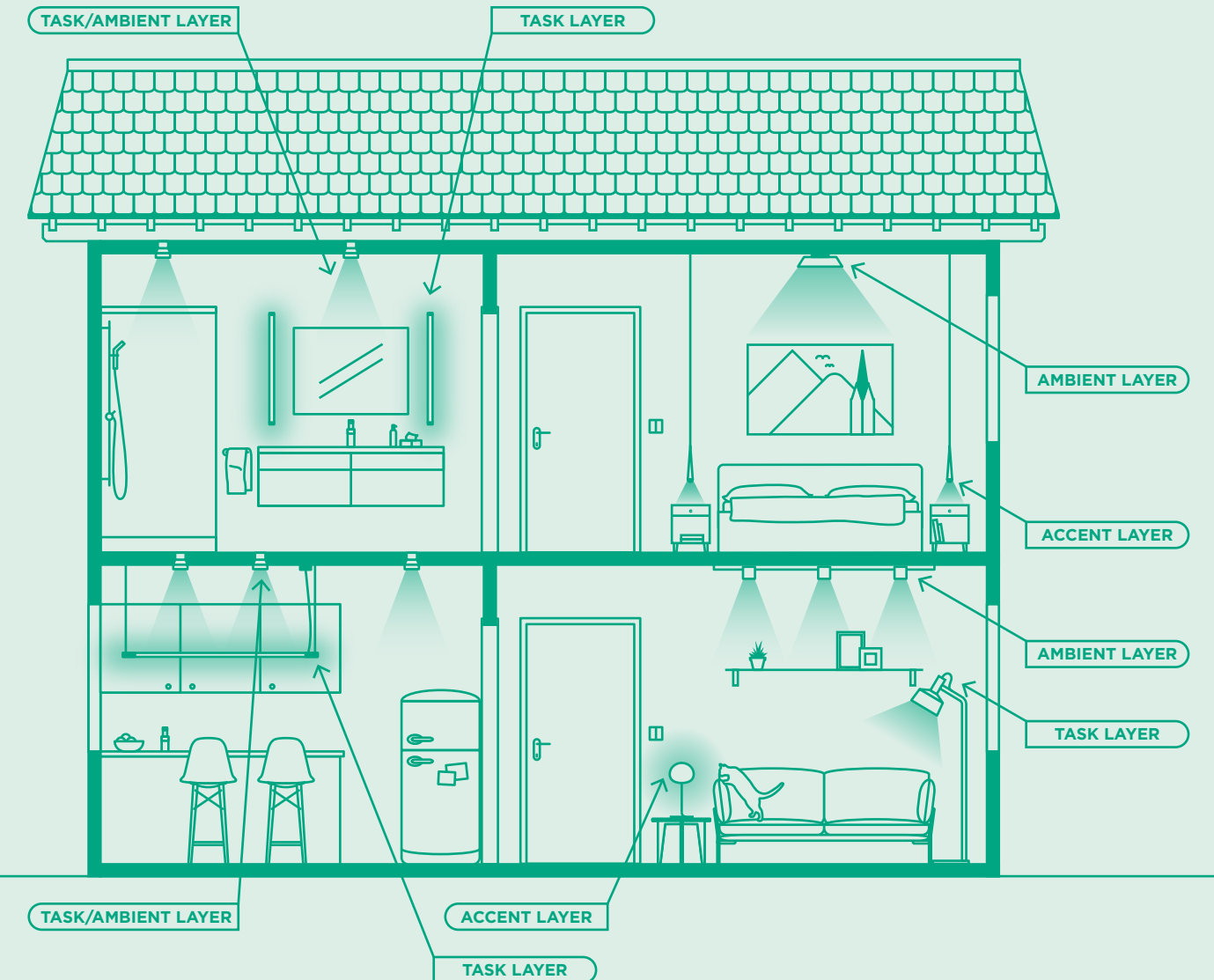



## WE ARE MORE THAN ONE

Have you discovered our family icon? Yay! Then your favourite luminaire is available in at least three variants.

Sie haben unser Family-Icon entdeckt? Yey! Dann ist Ihre Lieblingsleuchte in mindestens drei Varianten erhältlich.

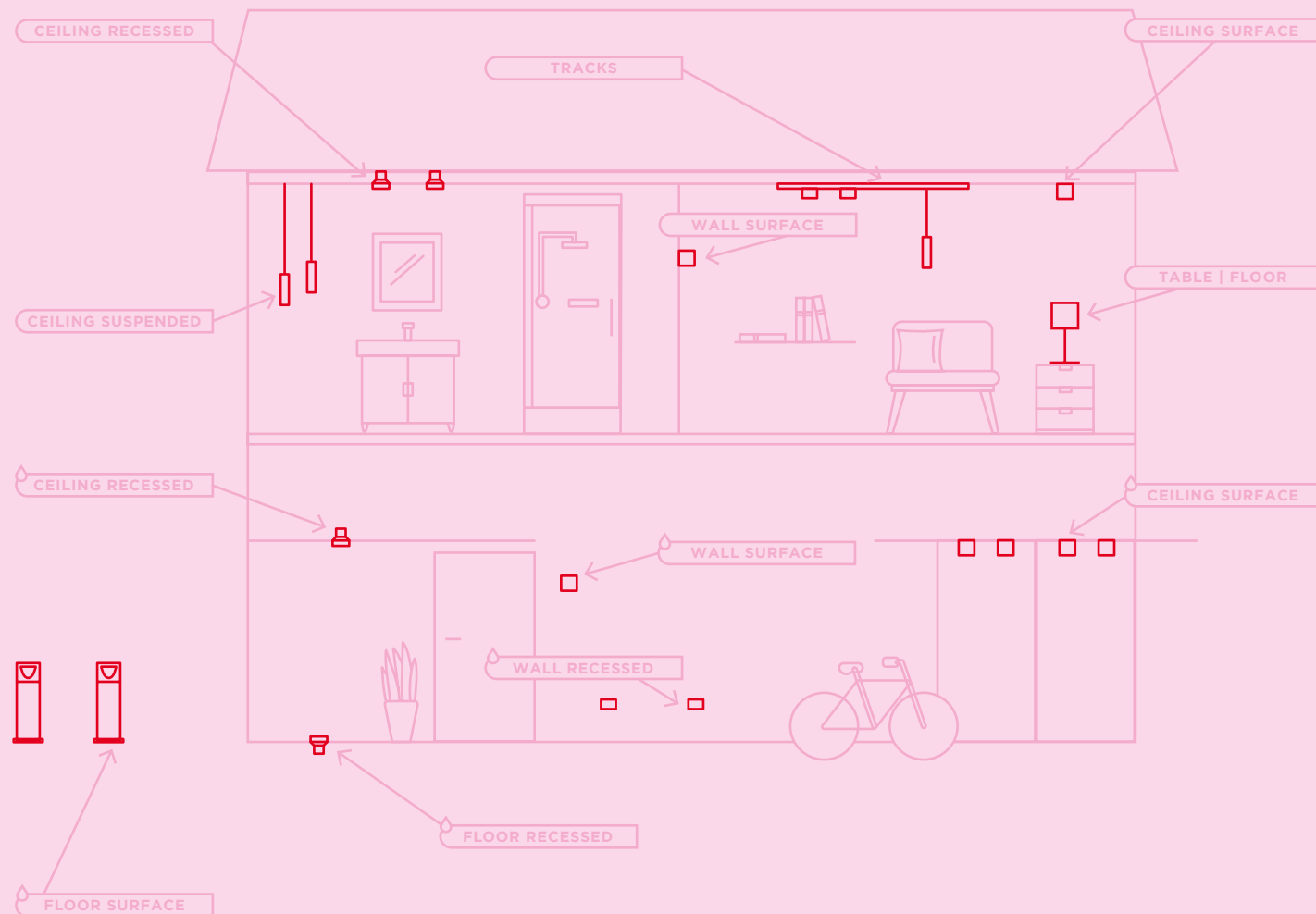
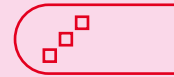

Have you fallen in love with a design so much that you wish you were surrounded by it all the time? No problem. Just take a quick look to see if the family icon is there and there's nothing standing in the way of your wish. After all, lights with this icon are available in at least three variants. In this way, rooms can be designed in a completely uniform style. By the way: Of course you can also pursue your need for harmony outdoors. Our outdoor variants make it possible.





































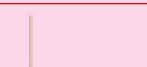

Sie haben sich so sehr in ein Design verliebt, dass Sie es am liebsten ständig um sich hätten? Kein Problem. Einfach kurz nachsehen, ob Sie das Family-Icon entdecken, und schon steht Ihrem Wunsch nichts mehr im Wege. Schließlich sind Leuchten mit dieser Kennung in mindestens drei Varianten erhältlich. So lassen sich Räume in einem ganz einheitlichen Stil gestalten. Übrigens: Ihrem Harmoniebedürfnis können Sie natürlich auch im Außenbereich nachgehen. Unsere Outdoor-Varianten machen's möglich.











































## WE THOUGHT THAT

# Three of us is a *product family*



# Highlight families

<b>CENO</b> 34 – 35	 <b>SEMI-RECESSED</b> 119	 <b>CEILING</b> 227	 <b>ON STREX</b> 303	 <b>FORT ON 3-PHASE TRACK</b> 353	 <b>WALL</b> 513			
<b>MATCH</b>	 <b>RECESSED</b> 57	 <b>SEMI-RECESSED</b> 113	 <b>CEILING</b> 223	 <b>ON STREX</b> 307	 <b>SUSPENDED</b> 407	 <b>SNOOZE</b> 623	 <b>WALL</b> 515	 <b>FLOOR</b> 659
<b>PIRRO</b> 36 – 37	 <b>RECESSED</b> 93	 <b>CEILING</b> 205	 <b>ON 1-PHASE TRACK</b> 339	 <b>SYSTEM</b> 361				
<b>TRACE</b>	 <b>CEILING</b> 201	 <b>SPIN</b> 253	 <b>GRID</b> 257	 <b>SUSPENDED</b> 399	 <b>CHANDELIER</b> 373	 <b>WALL</b> 517	 <b>SLIM</b> 521	
<b>FINLIN</b> 44 – 45	 <b>CEILING</b> 277	 <b>SUSPENDED</b> 385	 <b>WALL</b> 609	 <b>WALL ROUND</b> 613	 <b>FLOOR</b> 657			
<b>ODREY</b>	 <b>ON STREX</b> 323	 <b>ON 1-PHASE TRACK</b> 345	 <b>SUSPENDED</b> 461	 <b>MULTI</b> 461	 <b>WALL</b> 525			
<b>CLEA</b> 48 – 49	 <b>SURFACE</b> 271	 <b>SUSPENDED</b> 483	 <b>MULTI</b> 483	 <b>WALL</b> 571				

<b>FIL</b>	 <b>CEILING</b> 251	 <b>SUSPENDED</b> 383	 <b>WALL</b> 615					
<b>PERLEZ</b> 46 – 47	 <b>SEMI-RECESSED</b> 155	 <b>SURFACE</b> 279	 <b>SPIN</b> 255	 <b>GRID</b> 259	 <b>WALL</b> 635	 <b>MIRROR CLIP</b> 637		
<b>ROOMOR</b> 38 – 39	 <b>OFFICE CEILING</b> 275	 <b>OFFICE ON TRACK</b> 357	 <b>SUSPENDED</b> 445	 <b>OFFICE SUSPENDED</b> 451	 <b>WALL</b> 561	 <b>TABLE</b> 653	 <b>FLOOR</b> 665	
<b>DRO</b> 40 – 41	 <b>CEILING</b> 263	 <b>ON TRACK</b> 341	 <b>SUSPENDED</b> 413	 <b>WALL</b> 557	 <b>TABLE</b> 649	 <b>TABLE / FLOOR</b> 647	 <b>FLOOR</b> 661	
<b>MIRRO</b>	 <b>CEILING</b> 267	 <b>CEILING SOFT</b> 269	 <b>SUSPENDED</b> 431	 <b>SUSPENDED SOFT</b> 433	 <b>WALL</b> 581	 <b>WALL SOFT</b> 585	 <b>TABLE</b> 651	 <b>FLOOR</b> 663
<b>WIRO</b>	 <b>CEILING</b> 265	 <b>CONE</b> 417	 <b>WIRO</b> 417	 <b>DIAMOND</b> 423	 <b>GLOBE</b> 427	 <b>WALL</b> 569		
<b>J.J.W.</b> 42 – 43	 <b>CEILING</b> 273	 <b>SUSPENDED</b> 437	 <b>SUSPENDED</b> 439	 <b>WALL</b> 573	 <b>WALL</b> 577			

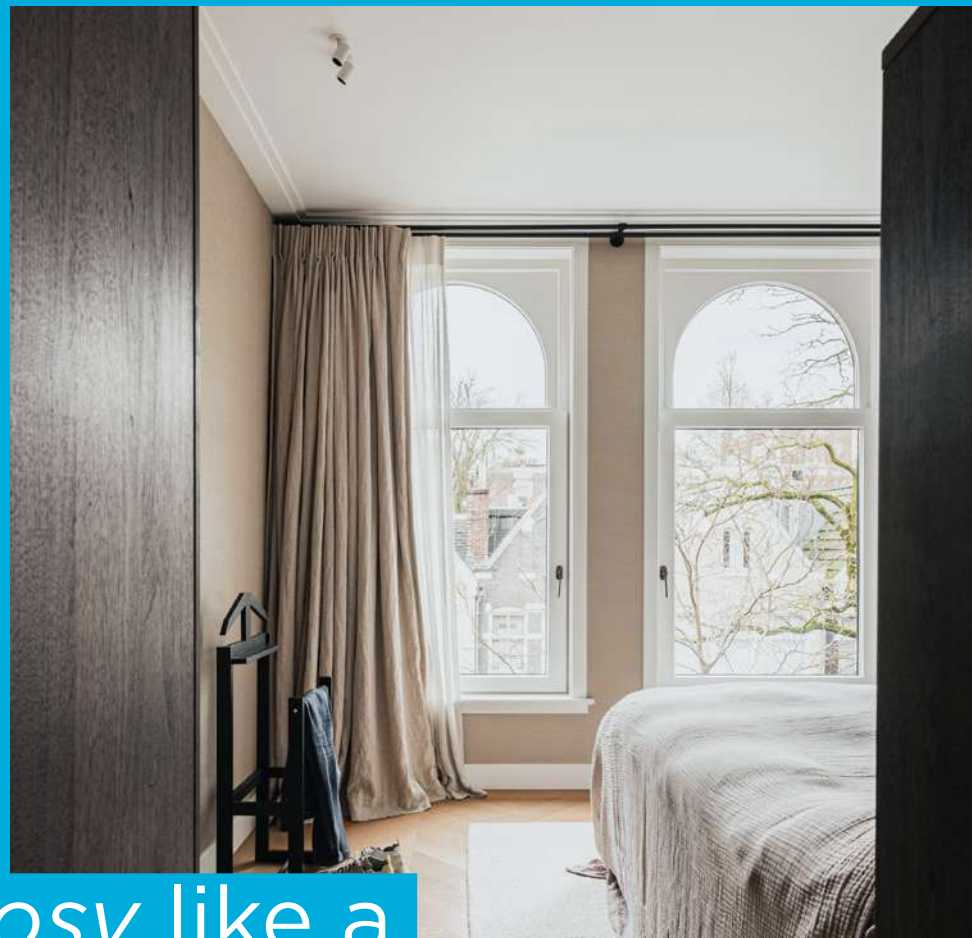

Cosy like a  
Sunday morning.

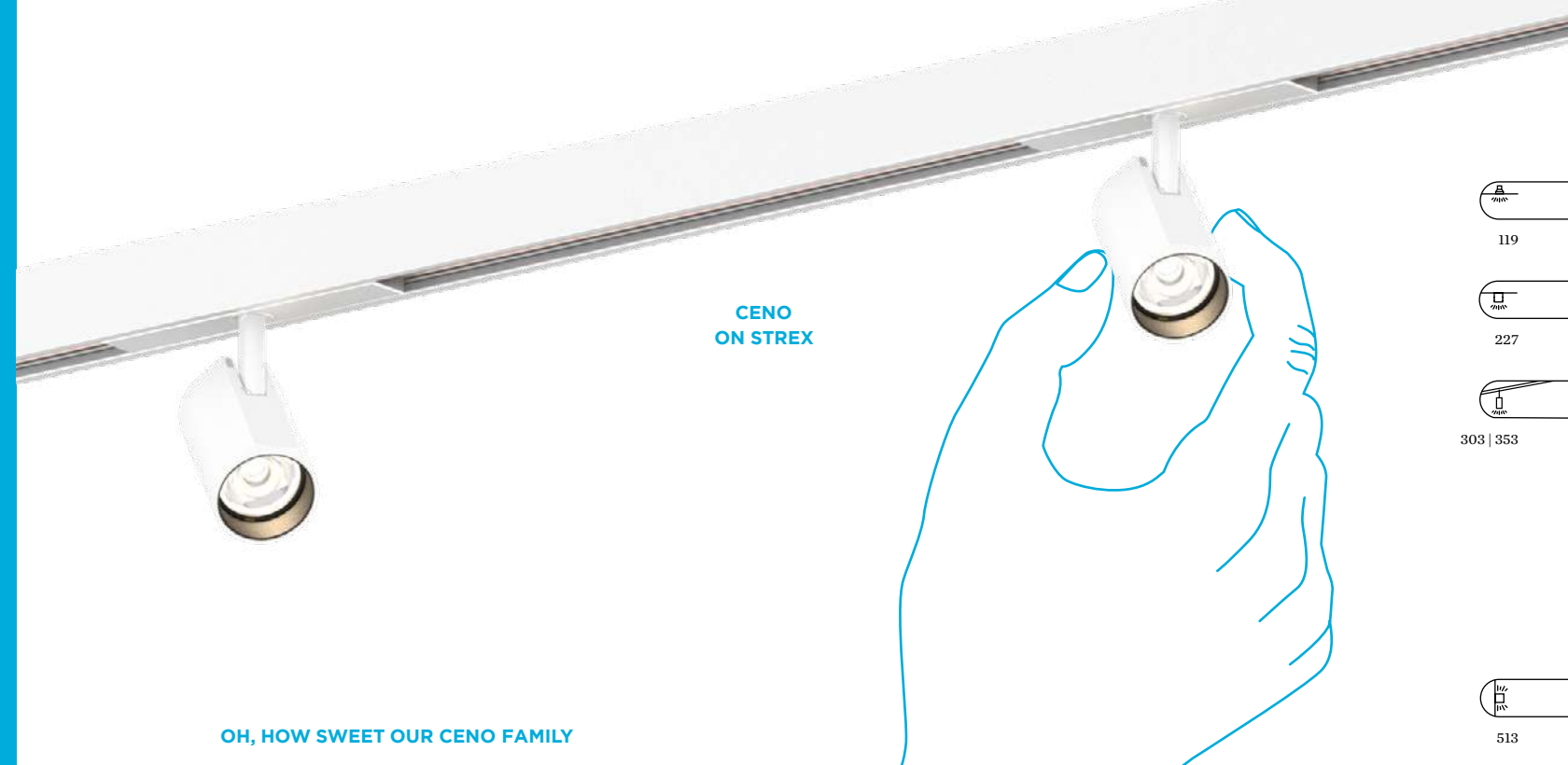

OH, HOW SWEET OUR CENO FAMILY

## Small spots, massive impact

The spots of the CENO family being small and inconspicuous has nothing to do with shyness. Our designers wanted to create a range of luminaires that would effortlessly make even tiny or winding spaces shine, without taking up much space. Perfectly done. That's why our CENOs are also available in many surface-mounted and recessed versions and even as insets for our STREX system. Are you looking for a discreet wall luminaire? Then we recommend the Wall Edition with indirect light. Like all CENOs, it is also available in many colours.



[weverducre.com/ceno](https://weverducre.com/ceno)

Dass die Spots der CENO-Familie so dezent sind, hat nichts mit Schüchternheit zu tun. Unsere Designer wollten einfach nur Leuchten entwerfen, die selbst kleine oder verwinkelte Räume mühelos zum Strahlen bringen. Deshalb gibt's unsere CENOs auch in vielen Auf- und Einbauvarianten und sogar als Insets für unser STREX-System. Sie suchen nach einer dezenten Wandleuchte? Dann empfehlen wir die Wall Edition mit indirektem Licht. Auch sie ist, wie alle CENOs, in vielen Farben erhältlich.

119

227

303 | 353

513



PIRRO 4.0  
OPAL | SPOT  
ON 1-PHASE TRACK

PERFECT ANGLES WITH THE PIRRO FAMILY

## We love *sharp lines*

Especially when they look as stunning as the PIRRO family. That's why the Bauhaus-style light is one of our absolute favourites, both in the elegant recessed or surface-mounted variant, and also as a flexible track system. How does it work? Simply assemble SPOT or OPAL insets as a SYSTEM on the prefabricated track to create a small work of art on the ceiling. Want even more creative design options? Then you can combine the various insets with a track or bring even more light into the room with the PIRRO petit multi-spot.



[weverducre.com/pirro](https://weverducre.com/pirro)

Vor allem, wenn sie so toll aussehen wie bei der PIRRO-Family. Deshalb gehört die im Bauhaus-Stil designte Leuchte auch zu unseren absoluten Favourites. Und zwar nicht nur in der formschönen Ein- oder Aufbauvariante, sondern auch als flexibles Schienensystem. Wie's funktioniert? Einfach SPOT- oder OPAL-Insets als SYSTEM auf der vorgefertigten Schiene zusammenstellen und schon entsteht ein kleines Kunstwerk an der Decke. Noch mehr kreative Gestaltungsmöglichkeiten gewünscht? Dann können Sie die verschiedenen Insets auch mit einer Stromschiene kombinieren oder mit dem Multi-Spot PIRRO petit noch mehr Licht in den Raum bringen.

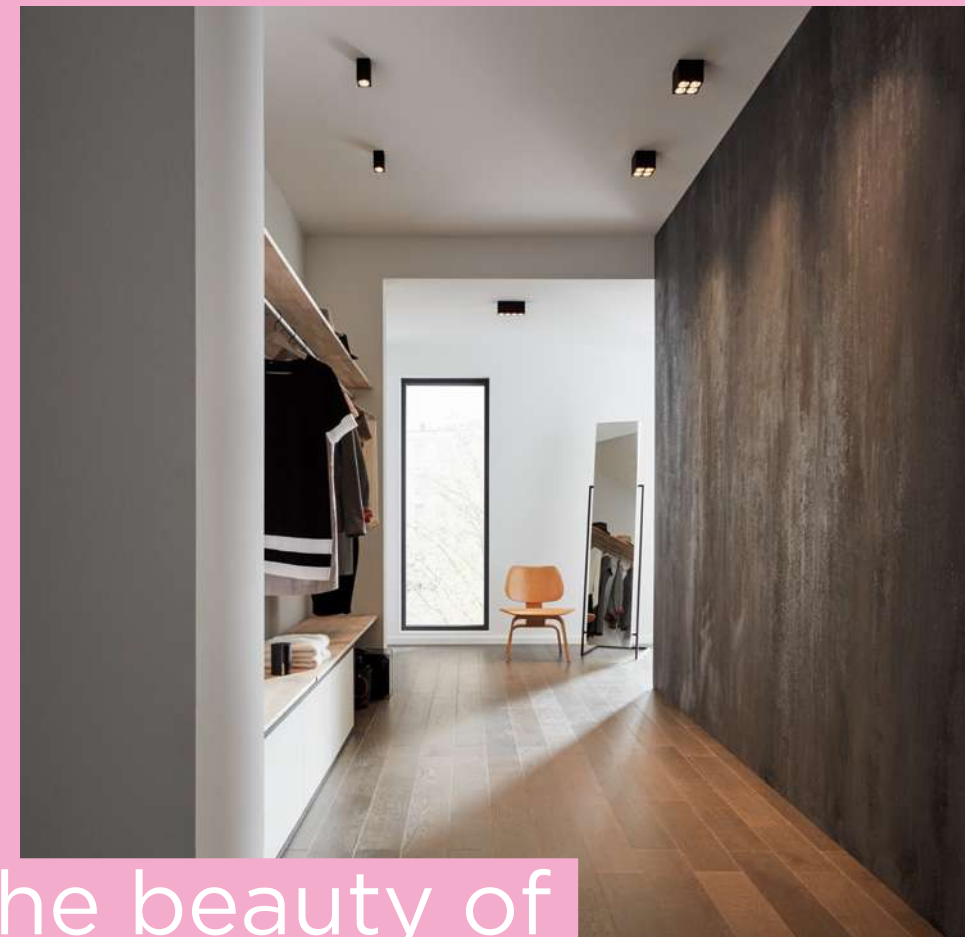

The beauty of  
*simplicity.*



91



203



339 | 361



Invite the  
ROOMOR *family*  
for dinner.

ROOMOR FAMILY HAS IT

## A true *all-rounder*

The rumours are true: ROOMOR is a lamp that can change its appearance faster than a chameleon. And all it takes is a few simple steps. Just choose the shape and colour and combine them to your heart's content. This allows ROOMOR to be transformed into everything from a minimalistic floor lamp to an opulent suspended luminaire or discreet table lamp. And because ROOMOR can be fully adapted to its surroundings when it comes to materials, all of the shade designs are offered in powder-coated aluminium and some also in finely textured felt. And to make things a little more fun in the office, ROOMOR is now also available as a glare-free office light with an UGR value of  $\leq 19$ . Nothing could be more flexible.



[weverducre.com/roomor](https://weverducre.com/roomor)

ROOMOR OFFICE  
CABLE SUSPENDED

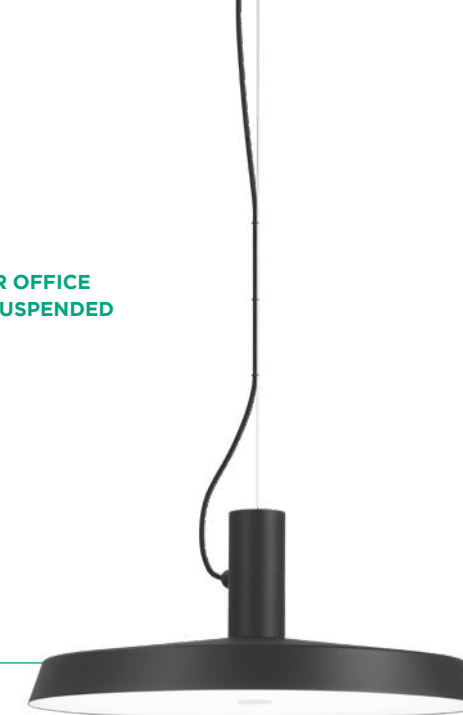

275



357



445 | 451



561



653 | 665

Sie können den Gerüchten ruhig glauben: ROOMOR ist eine Leuchte, die ihre Optik schneller wechselt als ein Chamäleon. Und das mit nur wenigen Handgriffen. Einfach Form und Farbe auswählen und loskombinieren. So wird aus ROOMOR mal eine minimalistische Stehlampe, mal eine opulente Hängelampe und mal eine dezente Tischlampe. Und weil sich ROOMOR auch in puncto Material ganz ihrer Umgebung anpasst, sind alle Schirmformen in pulverbeschichtetem Aluminium und manche auch in fein strukturiertem Filz erhältlich. Und damit es auch im Büro etwas abwechslungsreicher wird, gibt es ROOMOR nun auch als blendfreie Leuchte mit einem UGR-Wert  $\leq 19$ . Flexibler geht's nicht.



ANASTASIJA & MARTIN LESJAK, 13&9 DESIGN

## Products with *emotional* added value

At Studio 13&9, Anastasiya and Martin Lesjak focus entirely on “transferring the creative energy of a brand to the product”. This approach is also reflected in all the collections that the Austrian designer team has designed exclusively for Wever & Ducré. DRO stands out in particular, where the designer duo has been able to take the fleeting beauty of a dewdrop and capture it permanently. But the source of inspiration for 13&9 does not just come from nature, but many other creative areas, like the arts, fashion, and architecture. It is a transdisciplinary approach, which is expressed in a particularly attractive manner in the MIRRO collection, designed together with the designer Sabrina Stadlober. The metallic, reflective surface of the luminaires allows both the viewer and the surroundings to be reflected at the same time. An artisan’s device, used in this instance by 13&9, to closely connect the user with the product. And it is just such details, in the pieces designed by 13&9, that draw the fascination of everyone.

Anastasiya und Martin Lesjak vom Studio 13&9 konzentrieren sich ganz darauf, „die kreative Energie einer Marke auf das Produkt zu übertragen“. Dieser Ansatz spiegelt sich auch in allen Kollektionen wider, die das österreichische Designteam exklusiv für Wever & Ducré entworfen hat. Allen voran: DRO, mit der es den beiden Designern gelungen ist, die flüchtige Schönheit eines Taupfens dauerhaft einzufangen. Inspirieren lassen sich 13&9 aber nicht nur von der Natur, sondern auch von vielen anderen Kreativbereichen wie Kunst, Mode oder Architektur. Eine transdisziplinäre Herangehensweise, die bei der mit Designerin Sabrina Stadlober entworfenen Kollektion MIRRO besonders schön zum Ausdruck kommt. Gleichzeitig können sich Betrachter und Umgebung in der metallisch reflektierenden Oberfläche der Leuchten spiegeln. Ein gekannter Kunstgriff, mit dem 13&9 eine intensive Verbindung zwischen Benutzer und Produkt herstellen. Und genau das ist es auch, was die besondere Faszination aller von 13&9 entworfenen Objekte ausmacht.



[weverducre.com/dro](https://weverducre.com/dro)



Inspired by the *shapes* of nature.



263



341



413



557



647 | 661

Meet J.J.W. at  
the club or your  
*favourite* cafe.



## Elegant and *timeless*

J.J.W. by JULES WABBES

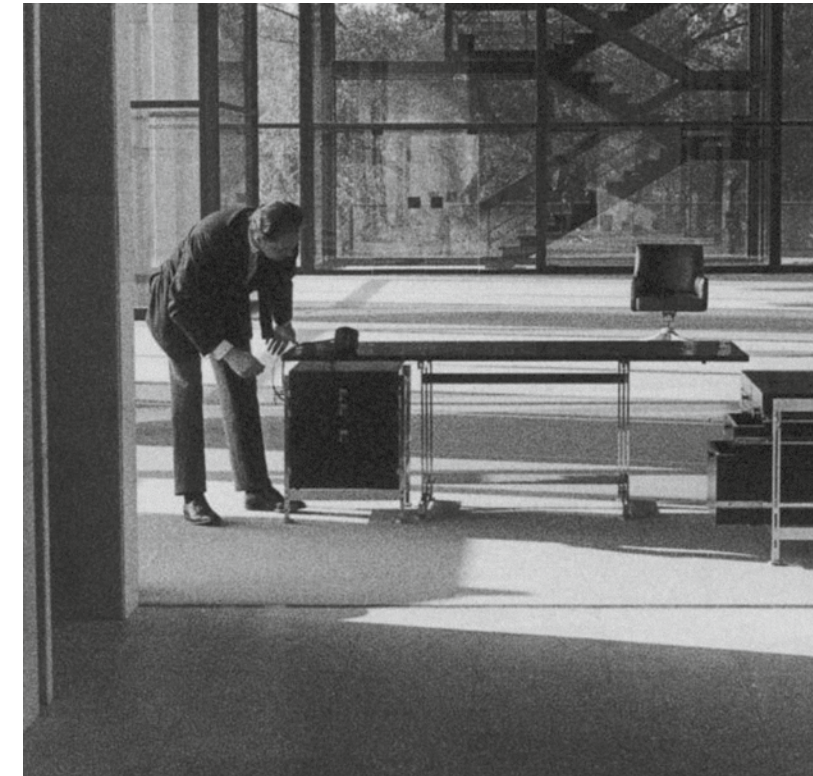

Jules Wabbes (1919–1974), who had a penchant for finding new ideas at flea markets, must have had the same thought. It's no wonder people said that the Belgian architect and furniture designer had a unique eye for shapes and materials. And that is apparent in his countless designs, which still haven't gone out of fashion even today. A shining example is the chandelier, developed in the 1970s, whose futuristic, floral form is as much at home in a modern bar as in a posh hotel lobby.

So oder so ähnlich könnte Jules Wabbes (1919–1974) gedacht haben, der sich gerne auf Flohmärkten inspirieren ließ. Kein Wunder, dass man dem belgischen Architekten und Möbeldesigner einen ganz besonderen Blick für Formen und Materialien nachsagte. Dieser manifestiert sich in seinen zahlreichen Entwürfen, die bis heute nicht aus der Mode gekommen sind. Bestes Beispiel: Ein in den 1970er Jahren entworfener Kronleuchter, dessen futuristische, florale Form sich damals wie heute gleichermaßen perfekt in moderne Bars und edle Hotel-Lobbys einfügt.



[weverducre.com/jjw](https://www.weverducre.com/jjw)

Jules Wabbes with one of his desks at the Royale Belge, Brussels, 1971,  
©Wabbes Sofam, Brussels, 2017.

LESS IS MORE WITH THE FINLIN FAMILY

## Follow the *line*

Admittedly, at first glance, the lights in the FINLIN family could also pass for modern sculptures. In reality, however, the delicate designs are made of wafer-thin aluminium tubes that appear to float almost weightlessly in the room. This creates a very fine, completely pared-back look that will make the hearts of design minimalists beat faster. FINLIN impresses both as a linear ceiling or suspended light and also as a round wall element that can customise even large areas. FINLIN is available in plain black and shimmering gold, and is now also available as a free-standing light.



[weverducre.com/finlin](https://weverducre.com/finlin)

Zugegeben, auf den ersten Blick könnten die Leuchten der FINLIN-Familie auch als moderne Skulpturen durchgehen. In Wahrheit bestehen die filigranen Designs aber aus hauchdünnen Aluminiumrohren, die fast schwerelos im Raum zu schweben scheinen. So entsteht eine sehr feine, vollkommen reduzierte Optik, die vor allem das Herz von Design-Minimalisten höher schlagen lässt. Schließlich überzeugt FINLIN nicht nur als lineare Decken- oder Pendelleuchte, sondern auch als rundes Wandelement, mit dem sich selbst große Flächen ganz individuell gestalten lassen. Erhältlich ist FINLIN in schlichtem Schwarz und schimmerndem Gold und ab sofort auch als Stehleuchte.

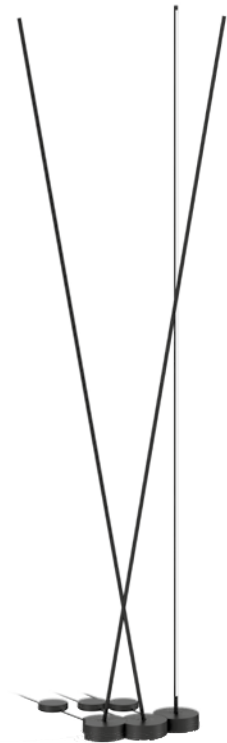

FINLIN FLOOR

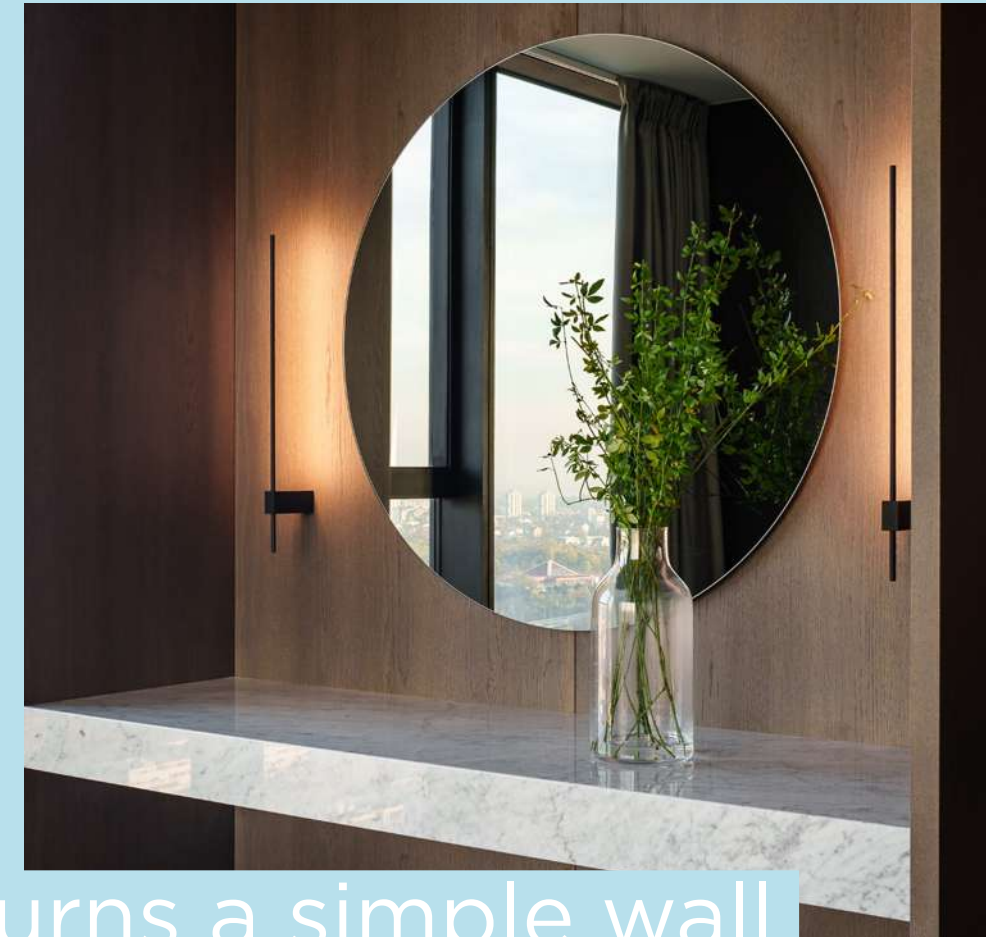

Turns a simple wall into a *piece of art*.



277



385



609



657





Let light  
*follow* you.



PERLEZ's gentle light and soft, round shape is reminiscent of a small, shimmering pearl. And as befits a true favourite piece of jewellery, it can also be combined with an infinite number of styles – whether as a minimalist ceiling light or as an elegant clip on the edge of a mirror. PERLEZ's uniform light makes any room shine. Thanks to its IP44 certification, the round opal glass light is ideally protected against splashing water and thus can even be used in bathrooms.

Mit ihrem sanften Licht und der weichen, runden Form erinnert PERLEZ an eine kleine, schimmernde Perle. Und wie sich das für ein echtes Liebblingsschmuckstück gehört, lässt sie sich auch mit unendlich vielen Stilen kombinieren. Ob als minimalistische Deckenleuchte oder als formschöner Clip am Spiegelrand – mit ihrem gleichmäßigen Licht bringt PERLEZ jeden Raum zum Strahlen. Dank IP44-Zertifizierung ist die runde Opalglas-Leuchte nämlich optimal vor Spritzwasser geschützt und lässt sich so selbst im Badezimmer problemlos einsetzen.

PERLEZ BRIGHTENS UP EVERY ROOM

## A true *gem*

What else does PERLEZ surprise us with? With SPIN and GRID, two unusual mounting variants that allow the light to be positioned completely independently of the power outlet. Do you want to adapt your lighting spontaneously to any situation? Then SPIN's swivelling arms make this a reality with just one simple adjustment. To illuminate larger areas such as the dining or living room table, PERLEZ is best combined with GRID, allowing four of the beautifully designed lights to shine from the ceiling.

Womit PERLEZ noch überrascht? Mit SPIN und GRID, zwei außergewöhnlichen Mounting-Varianten, mit denen sich die Leuchte ganz unabhängig vom Stromauslass positionieren lässt. Sie möchten Ihre Beleuchtung spontan an jede Situation anpassen? Dann ist das mit SPIN's schwenkbaren Armen mit nur einem Handgriff möglich. Für die Ausleuchtung größerer Flächen, wie zum Beispiel des Ess- oder Wohnzimmeres, kombiniert man PERLEZ am besten mit GRID und lässt so gleich vier der formschönen Leuchten von der Decke strahlen.



[weverducre.com/perlez](https://weverducre.com/perlez)





CLEA 1.0 | 2.0

SOMETIMES THERE'S NOTHING LEFT TO ADD

## A perfect circle

Design is at its best when colour and shape are in perfect harmony. As with the CLEA family, whose circular shade comes in three sizes and various colours. The special feature here is that the shades "feel jade!" and "live simple!" are part of the "Sustained Colors" line by COLORNETWORK®, which is fully committed to the sustainable definition of colour concepts. Entire interiors can thus be designed in the same tone or in matching colour families. It's great that the CLEA family is also part of this philosophy and shares the same inner values. It makes you want to have the beautifully designed lights, whose light sources emit a particularly soft light, in your home even more. After all, they can be used to create highly decorative highlights on walls and ceilings.



[weverducre.com/clea](https://weverducre.com/clea)

Design ist am schönsten, wenn Farbe und Form in perfektem Einklang stehen. Wie bei der CLEA-Family, deren kreisrunde Schirme in drei Größen und verschiedenen Farben zu haben sind. Das Besondere dabei: Die Nuancen „feel jade!“ und „live simple!“ gehören zu den „Sustained Colors“ von COLORNETWORK®, das sich ganz der nachhaltigen Definition von Farbkonzepten verschrieben hat. So können ganze Interieurs im selben Ton gestaltet werden. Schön, dass auch die CLEA-Family Teil dieser Philosophie ist und nicht nur mit außergewöhnlichem Design, sondern auch mit inneren Werten punktet. Da möchte man die formschönen Leuchten, deren Glaskörper ein besonders weiches Licht spenden, doch gleich noch lieber zu Hause haben. Schließlich lassen sich mit ihnen an Wand und Decke besonders dekorative Highlights setzen.

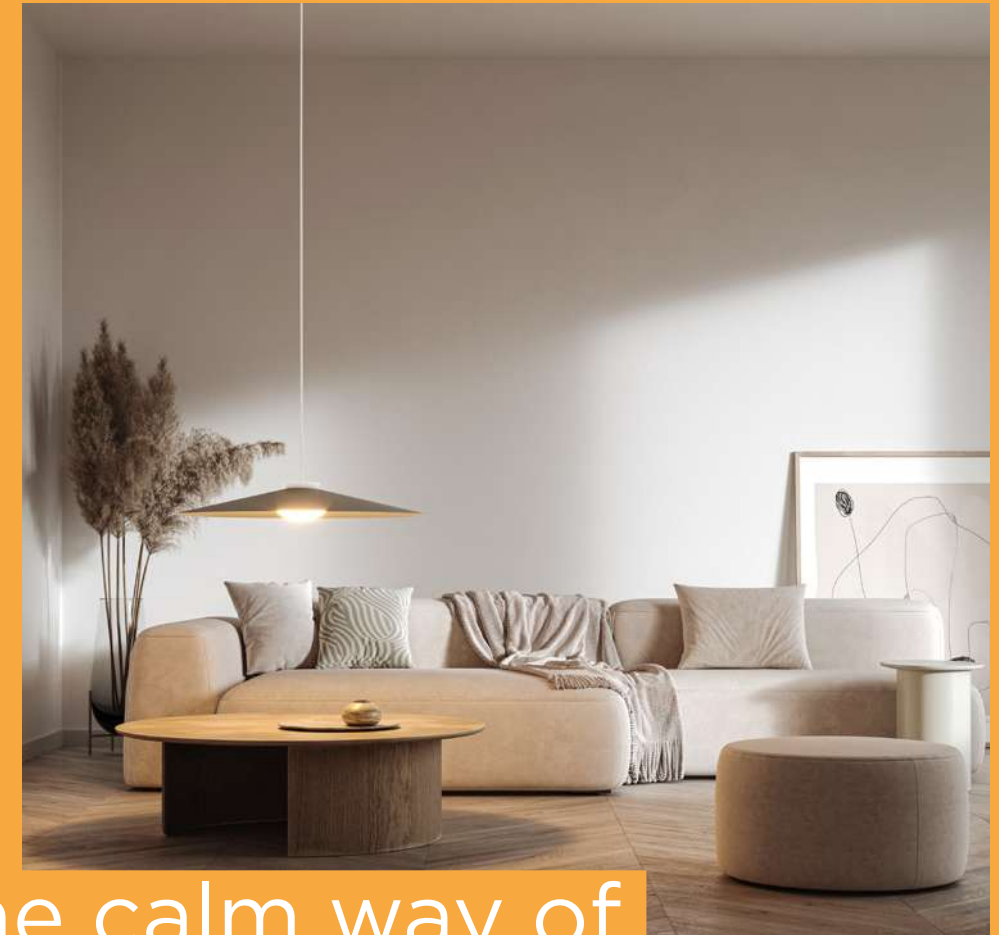

The calm way of showing style.



271



483























571

## *Indoor*



















A home is a place where we want to relax above all else. At the same time, a lot happens here. We play, cook, and, more and more often, work.

It's good to know that a modern LED system adapts flexibly to all these needs.

**SPOT LIGHTS**

	 <i>new</i>			
<b>MATCH POINT</b> 57	<b>DEEP POINT</b> 59	<b>DEEP BIJOU</b> 61	<b>DEEP PETIT</b> 63	<b>DEEP</b> 65
		 <i>new</i>		
<b>DEEPER</b> 67	<b>DEEP ADJUST PETIT</b> 69	<b>DEEP ADJUST PETIT TRIMLESS</b> 69	<b>DEEP ADJUST</b> 71	<b>DEEP ADJUST TRIMLESS</b> 75
		 <i>new</i>		
<b>DEEP ADJUST FORT</b> 79	<b>SPINEO</b> 81	<b>RONY POINT</b> 83	<b>RONY</b> 85	<b>RON</b> 87
		 <i>new</i>		
<b>PIRRO</b> 93	<b>PLANO PETIT</b> 97	<b>PLANO</b> 99	<b>STRANGE PETIT TRIMLESS</b> 101	<b>STRANGE TRIMLESS</b> 103
				
<b>SNEAK TRIMLESS</b> 107				

**SEMI RECESSED**

 <i>new</i>				
<b>LECA</b> 109	<b>MATCH</b> 113	<b>MATCH STICK</b> 117	<b>CENO</b> 119	<b>BLIEK PETIT</b> 123
				
<b>BLIEK PETIT TRIMLESS</b> 123	<b>BLIEK ROUND</b> 127	<b>BLIEK SQUARE</b> 129	<b>RUVI</b> 131	
		 <i>new</i>		
<b>DEEP POINT IP44</b> 135	<b>DEEP BIJOU IP65</b> 137	<b>DEEP PETIT IP65</b> 139	<b>DEEP IP65   IP44</b> 141	<b>DEEPER IP44</b> 143
			 <i>new</i>	 <i>new</i>
<b>MATCH POINT IP44</b> 145	<b>TAIO IP65</b> 147	<b>RINI SNEAK IP44</b> 149	<b>LUNA ROUND IP44</b> 151	<b>LUNA SQUARE IP44</b> 151
 <i>new</i>				
<b>PERLEZ IP44</b> 155	<b>MIRBI IP44 1.0</b> 157	<b>MIRBI IP44 2.0</b> 157	<b>CITY IP44</b> 159	

# How deep is your deep?

## DEEP

FIX



**point 1.0**  
LED  
p. 59



**bijou 1.0**  
LED  
p. 61



**bijou 2.0**  
LED  
p. 61



**petit 1.0**  
LED  
p. 63



**1.0**  
LED | MR16 | PAR16  
p. 65



**point IP44 1.0**  
LED  
p. 135



**bijou IP65 1.0**  
LED  
p. 137



**petit IP65 1.0**  
LED  
p. 139

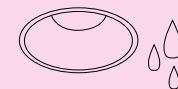

**IP65 | IP44 1.0**  
LED | MR16 | PAR16  
p. 141

## DEEP ADJUST

ADJUSTABLE

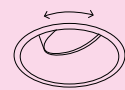

**petit 1.0**  
LED  
p. 69

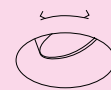

**petit trimless 1.0**  
LED  
p. 69

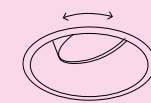

**1.0**  
LED | MR16 | PAR16  
p. 71

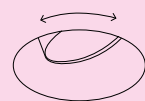

**trimless 1.0**  
LED | MR16 | PAR16  
p. 75

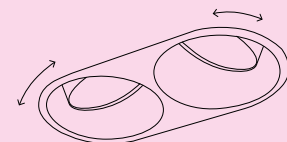

**2.0**  
LED | PAR16  
p. 73

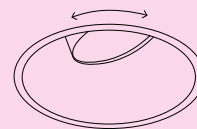

**fort 1.0**  
LED  
p. 79

## DEEPER

FIX

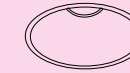

**1.0**  
LED | MR16 | PAR16  
p. 67



**IP44 1.0**  
LED | MR16 | PAR16  
p. 143

### DEEP CONNECTIONS

DEEP and DEEPER are classic downlights and send their light beam straight down. Perfect for any room, be it a hallway or living room. But the recessed lights have so much more to offer. DEEP and DEEPER have an IP44 variant with splash protection, and for DEEP we even have IP65 variants with protection against low pressure water jets. This means you can also mount the starry sky in your bathroom. Incidentally, DEEP ADJUST and DEEP ADJUST petit are available in a trimless version, which seem like they are virtually invisible as they disappear into your ceiling.

DEEP und DEEPER sind klassische Downlights und geben ihren Lichtstrahl gerade nach unten ab. Perfekt für alle Räume, egal ob Flur oder Wohnzimmer. DEEP und DEEPER gibt's als IP44-Variante spritzwassergeschützt und DEEP sogar als IP65-Varianten strahlwassergeschützt. Da kann man sich den Sternenhimmel auch ins Badezimmer montieren. Übrigens: DEEP ADJUST und DEEP ADJUST petit gibt's als Trimless-Variante, die fast unsichtbar in der Decke verschwindet.

## DEEP ADJUST

ASYM

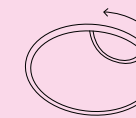

**asym 1.0**  
LED | PAR16  
p. 77

### DON'T BE SHY

Want to place your Ming vase in the right light? Then the swivelling spotlights from the DEEP range are the ideal solution for you. This means your vase can be moved around and still remain perfectly lit. Simply readjust by hand. Do you actually have a fresco mural or a special surface structure? Then DEEP ADJUST asym is the perfect solution: The consistent wall washer effect will certainly WOW your guests. Guaranteed.

Sie möchten Ihre Ming-Vase ins rechte Licht rücken? Dann sind die schwenkbaren Spots der DEEP-Familie die perfekte Lösung für Sie. Damit kann die Vase nämlich auch mal wandern und sie bekommt trotzdem wieder das perfekte Licht. Einfach händisch nachjustieren. Sie haben tatsächlich ein Wandfresko oder eine besondere Oberflächenstruktur? Dann ist DEEP ADJUST asym die perfekte Lösung: Der gleichmäßige Wallwasher-Effekt wird Ihren Gästen ein WOW entlocken. Garantiert.



[weverducre.com/deep](http://weverducre.com/deep)

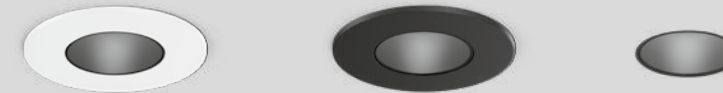
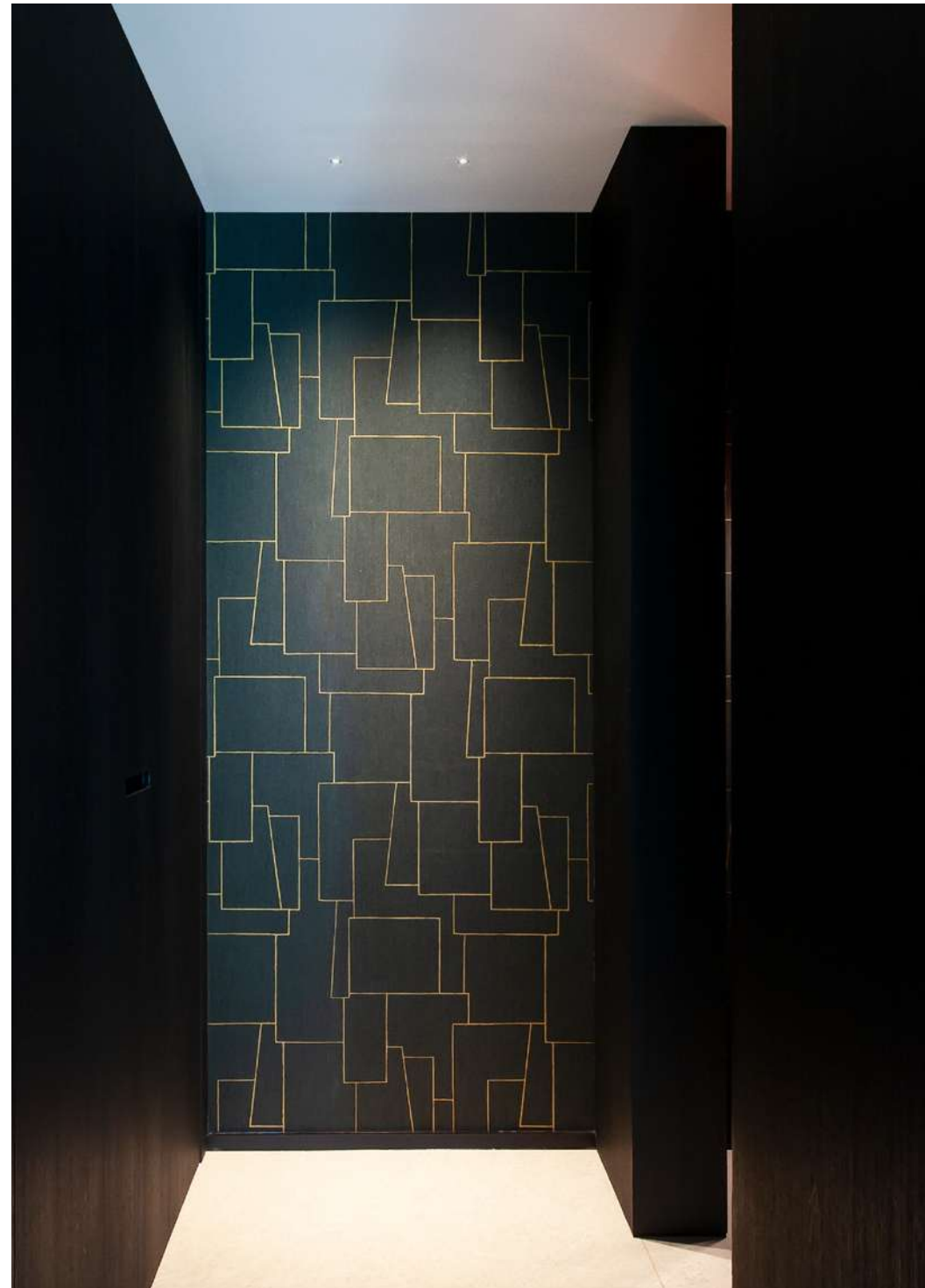

# MATCH point

Ceiling recessed



reddot winner 2023



223



307 | 321

As awarded by The Chicago Athenaeum: Museum of Architecture and Design

407



ø45



ø45

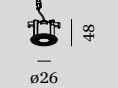

ø26

## 1.0

LED COB 5W | 250mA | 18V aluminium

IP20 32° SDCM2 L80|50K 0.06kg

wire springs 40-41 68 4-25

## 1.0 IP44

LED COB 5W | 250mA | 18V aluminium

IP44 32° SDCM2 L80|50K 0.06kg

wire springs 40-41 68 4-25

## 1.0 TRIMLESS

LED COB 5W | 250mA | 18V aluminium

IP20 32° SDCM2 L80|50K 0.08kg

45-47 60 4-26

	CODE
	191161W_
	191161B_

LIGHT COLOUR	LUMEN	CRI	CODE
2700K	320	>90	3
3000K	350	>90	5

## ALWAYS USE

driver | 250mA

	CODE
5W dim	90226201
13W DALI*	90246501

\*revision opening required  
more options and specs on page 806

	CODE
	191261W_
	191261B_

LIGHT COLOUR	LUMEN	CRI	CODE
2700K	300	>90	3
3000K	330	>90	5

## ALWAYS USE

driver | 250mA

	CODE
5W dim   IP20	90226201
13W DALI   IP20*	90246501

\*revision opening required  
more options and specs on page 806

	CODE
	191861B_

LIGHT COLOUR	LUMEN	CRI	CODE
2700K	270	>90	3
3000K	300	>90	5

## ALWAYS USE

driver | 250mA

	CODE
5W dim	90226201
13W DALI	90246501

revision opening required  
more options and specs on page 806

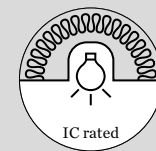
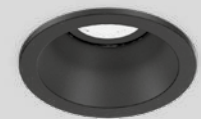

IC rated

# DEEP point

Ceiling recessed

new



ø45



ø45

## 1.0

LED COB 4W | 250mA | 18V  
aluminium

IP20 A 32° SDCM2 L80|50K 0.06kg

wire springs ⌀40-41 1.68 4-25

	CODE
	185261W_
	185261M_
	185261Q_
	185261B_

LIGHT COLOUR	LUMEN CRI	CODE
2700K	390 >90	3
3000K	430 >90	5

## ALWAYS USE

driver | 250mA

	CODE
5W dim	90226201
13W DALI*	90246501

\*revision opening required  
more options and specs on page 806

## 1.0 IP44

LED COB 4W | 250mA | 18V  
aluminium

IP44 A 32° SDCM2 L80|50K 0.06kg

wire springs ⌀40-41 1.68 4-25

	CODE
	185161W_
	185161B_

LIGHT COLOUR	LUMEN CRI	CODE
2700K	370 >90	3
3000K	410 >90	5

## ALWAYS USE

driver | 250mA

	CODE
5W dim   IP20	90226201
13W DALI   IP20*	90246501

\*revision opening required  
more options and specs on page 806



# DEEP bijou

Ceiling recessed

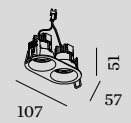

## 1.0

LED COB 4W | 250mA | 17V  
aluminium

IP20 A 31° SDCM2 L80|50K 0.07kg

wire springs 50-52 85 4-25

## 2.0

2x LED COB 4W | 250mA | 34V  
aluminium

IP20 A 31° SDCM2 L80|50K 0.15kg

wire springs 50-52x100-104 67 4-25

	CODE
	165161W_
	165161M_
	165161G_
	165161Q_
	165161B_

LIGHT COLOUR	LUMEN CRI	CODE
2700K	400 >90	3
3000K	450 >90	5

	CODE
	165261W_
	165261M_
	165261G_
	165261B_

LIGHT COLOUR	LUMEN CRI	CODE
2700K	2x400 >90	3
3000K	2x450 >90	5

### ALWAYS USE

driver | 250mA

	CODE
5W dim	90226201
13W DALI	90246501

more options and specs on page 806

### ALWAYS USE

driver | 250mA | only 1x needed

	CODE
10.5W dim	90226501
13W DALI	90246501

more options and specs on page 806

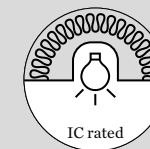
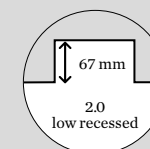

BLADE SPRING VERSIONS ONLINE

[weverducre.com/more-deep-bijou](http://weverducre.com/more-deep-bijou)





# DEEP petit

Ceiling recessed

new

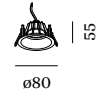

## 1.0

LED COB 6W | 350mA | 17V aluminium

IP20 31° SDCM2 L80|50K 0.04kg

wire springs 68-70 57 4-23

	CODE
	153561W_
	153561S_
	153561M_
	153561G_
	153561Q_
	153561B_

LIGHT COLOUR	LUMEN CRI	CODE
2700K	615 >90	3
3000K	650 >90	5
2000-3000K   16V	440 >90	9

## ALWAYS USE

driver | 350mA

	CODE
6W	90213303
10W dim	90223406
14W DALI	90243501

more options and specs on page 806

## 1.0 IP65

LED COB 6W | 350mA | 17V aluminium

IP65 31° SDCM2 L80|50K 0.10kg

wire springs 68-70 60 4-25

	CODE
	153761W_
	153761B_

LIGHT COLOUR	LUMEN CRI	CODE
2700K	590 >90	3
3000K	610 >90	5

## ALWAYS USE

driver | 350mA

	CODE
6W   IP20	90213303
10w dim   IP20	90223406
17W   IP68*	90213602

\*revision opening required  
more options and specs on page 806

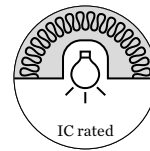
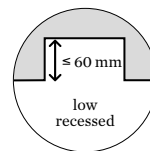



# DEEP

Ceiling recessed



## 1.0 LED

LED COB 6,9W | 350/500mA | 17V  
aluminium

IP20  $\Delta$  34° SDCM2 L80I55K 0,15kg

wire springs  $\varnothing$  76-79  $\perp$  90  $\approx$  4-27

	CODE
	184261W_
	184261S_
	184261M_
	184261G_
	184261B_

LIGHT COLOUR	LUMEN   CRI	CODE
2700K	530/710   >90	3
3000K	575/770   >90	5
4000K	615/825   >90	7
2000-3000K	380/560   >90	9

LED module 20 years replaceability

## ALWAYS USE

driver | 500mA

	CODE
10W	90214406
10W dim	90224403
24W DALI	90244701

more options and specs on page 808



## 1.0 MR16

QR-CBC51 max. 12W | GU5.3 | 12V  
aluminium

IP20 0,11kg

wire springs  $\varnothing$  76-79  $\perp$  90  $\approx$  4-27

	CODE
	112110W0
	112110S0
	112110M0
	112110G0
	112110B0

## ALWAYS USE

driver | 12V

	CODE
10W dim	90221401
25W dim	90221701

specs on page 810



## 1.0 PAR16

PAR16 max. 12W | GU10  
100-240VAC | 50-60Hz  
aluminium

IP20 0,12kg

wire springs  $\varnothing$  76-79  $\perp$  115  $\approx$  4-27

	CODE
	112120W0
	112120S0
	112120M0
	112120G0
	112120B0

## OPTIONAL

PAR16 6.5W | GU10 | phase-cut dim

	CODE
2700K   460lm	901228W3
2700K   437lm	901228B3
3000K   500lm	901228W5
3000K   457lm	901228B5



BLADE SPRING VERSIONS AND  
MORE BEAM ANGLES ONLINE

weverducre.com/more-deep

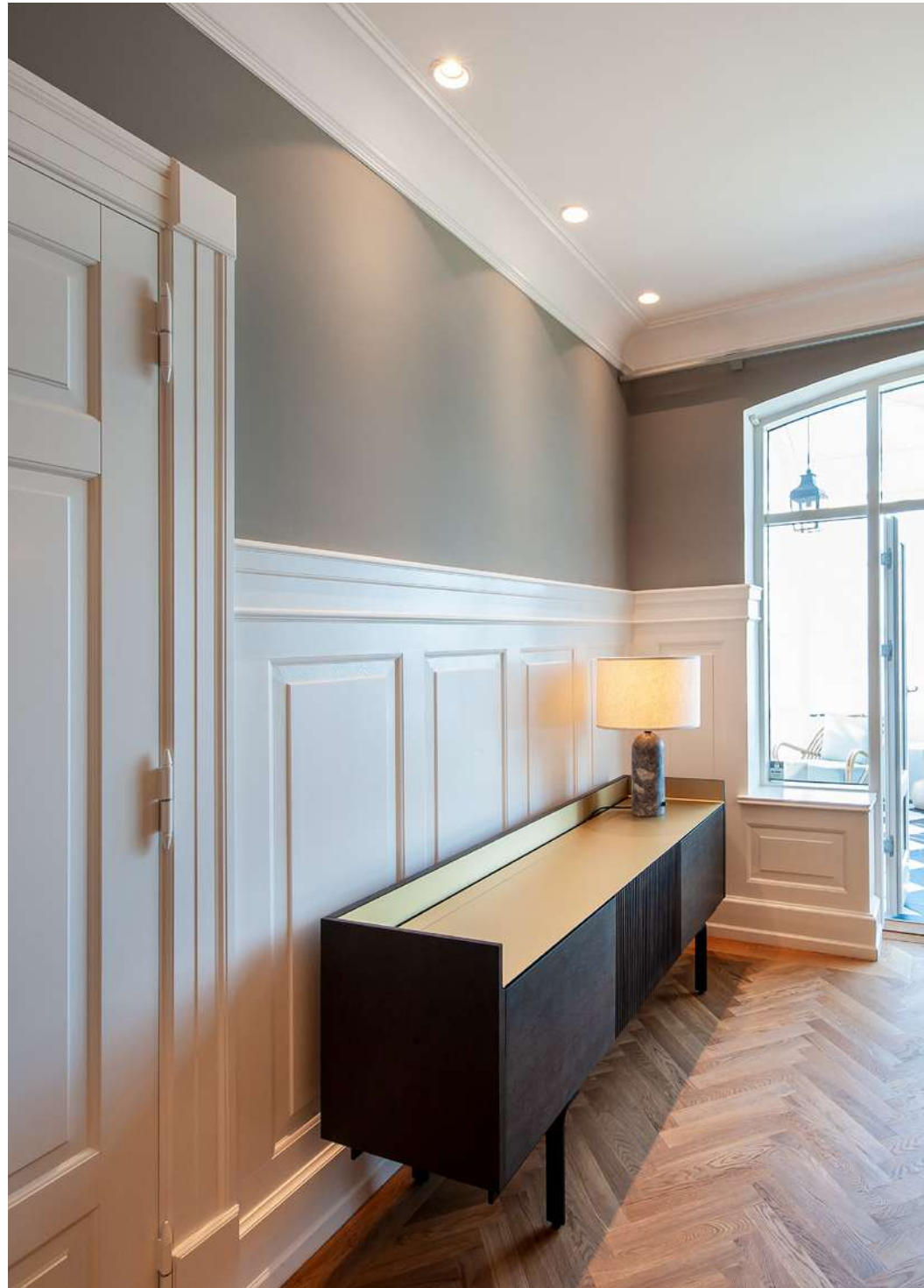

# DEEPER

Ceiling recessed

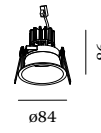

### 1.0 LED

LED COB 6/9W | 350/500mA | 17V aluminium

IP20 34° SDCM2 L80/55K 0.17kg

wire springs 76-79 90 4-38

Color	CODE
White	152361W_
Gold	152361S_
Black	152361G_
Dark Grey	152361Q_
Black	152361B_

LIGHT COLOUR	LUMEN CRI	CODE
2700K	505/685 >90	3
3000K	550/740 >90	5
2000-3000K	380/560 >90	9

LED module 20 years replaceability

### ALWAYS USE

driver | 500mA

Option	CODE
10W	90214406
10W dim	90224403
24W DALI	90244701

more options and specs on page 808

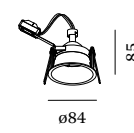

### 1.0 MR16

QR-CBC51 max. 12W | GU5.3 | 12V aluminium

IP20 0.11kg

wire springs 76-79 100 4-38

Color	CODE
White	152110W0
Gold	152110S0
Black	152110G0
Dark Grey	152110Q0
Black	152110B0

### ALWAYS USE

driver | 12V

Option	CODE
10W dim	90221401
25W dim	90221701

specs on page 810

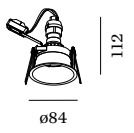

### 1.0 PAR16

PAR16 max. 12W | GU10 100-240VAC | 50-60Hz aluminium

IP20 0.15kg

wire springs 76-79 120 4-38

Color	CODE
White	152120W0
Gold	152120S0
Black	152120G0
Dark Grey	152120Q0
Black	152120B0

### OPTIONAL

PAR16 6.5W | GU10 | phase-cut dim

Option	CODE
2700K   460lm	901228W3
2700K   437lm	901228B3
3000K   500lm	901228W5
3000K   457lm	901228B5



BLADE SPRING VERSIONS AND MORE BEAM ANGLES ONLINE  
weverducre.com/more-deeper



# DEEP ADJUST petit

Ceiling recessed

new

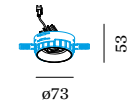

## 1.0

LED COB 6W | 350mA | 17V  
aluminium

IP20 0°-35°|355° 31° SDCM2 L70|50K 0.05kg

wire springs 68-70 65 4-23

CODE	153661W_
153661M_	
153661G_	
153661Q_	
153661B_	

LIGHT COLOUR	LUMEN CRI	CODE
2700K	540 >90	3
3000K	570 >90	5
2000-3000K   16V	440 >90	9

LED module 20 years replaceability

## ALWAYS USE

driver | 350mA

CODE	90213303
6W	
10W dim	90223406
14W DALI	90243501

more options and specs on page 806

## 1.0 TRIMLESS

LED COB 6W | 350mA | 17V  
aluminium

IP20 0°-35°|360° 31° SDCM2 L70|50K 0.07kg

CODE	153461W_
153461B_	

LIGHT COLOUR	LUMEN CRI	CODE
2700K	540 >90	3
3000K	570 >90	5
2000-3000K   16V	440 >90	9

LED module 20 years replaceability

## ALWAYS USE

alu plasterkit 78-80 65 12,5, 15, 20, 25

CODE	90017210

driver | 350mA

CODE	90213303
6W	
10W dim	90223406
14W DALI	90243501

more options and specs on page 806



BLADE SPRING VERSIONS AND  
MORE BEAM ANGLES ONLINE

weverducre.com/more-deep-adjust-petit

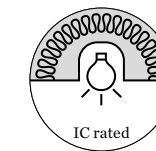
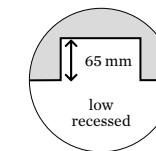



# DEEP ADJUST

Ceiling recessed



## 1.0 LED

LED COB 6/9W | 350/500mA | 17V aluminium

IP20 0°-35°/355° A 34° SDCM2 L80I55K 0.17kg

wire springs 86-89 11.90 4-23

CODE	
184361W	
184361S	
184361M	
184361G	
184361Q	
184361B	

LIGHT COLOUR	LUMEN	CRI	CODE
2700K	530/715	>90	3
3000K	575/775	>90	5
4000K	620/830	>90	7
2000-3000K	380/560	>90	9

LED module 20 years replaceability

### ALWAYS USE

driver | 500mA

	CODE
10W	90214406
10W dim	90224403
24W DALI	90244701

more options and specs on page 808

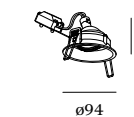

## 1.0 MR16

QR-CBC51 max. 12W | GU5.3 | 12V aluminium

IP20 0°-35°/355° 0.17kg

wire springs 86-89 11.90 4-23

CODE	
112310W0	
112310S0	
112310M0	
112310G0	
112310Q0	
112310B0	

LIGHT COLOUR	LUMEN	CRI	CODE
2700K	460lm	>90	3
2700K	437lm	>90	5
3000K	500lm	>90	7
3000K	457lm	>90	9

LED module 20 years replaceability

### ALWAYS USE

driver | 12V

	CODE
10W dim	90221401
25W dim	90221701

specs on page 810

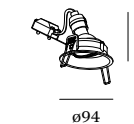

## 1.0 PAR16

PAR16 max. 12W | GU10 100-240VAC | 50-60Hz aluminium

IP20 0°-35°/355° 0.21kg

wire springs 86-89 11.15 4-23

CODE	
112320W0	
112320S0	
112320M0	
112320G0	
112320Q0	
112320B0	

LIGHT COLOUR	LUMEN	CRI	CODE
2700K	460lm	>90	3
2700K	437lm	>90	5
3000K	500lm	>90	7
3000K	457lm	>90	9

LED module 20 years replaceability

### OPTIONAL

PAR16 6.5W | GU10 | phase-cut dim

	CODE
2700K   460lm	901228W3
2700K   437lm	901228B3
3000K   500lm	901228W5
3000K   457lm	901228B5



BLADE SPRING VERSIONS AND MORE BEAM ANGLES ONLINE

weverducre.com/more-deep-adjust



# DEEP ADJUST

Ceiling recessed

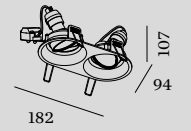
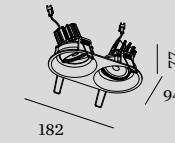

## 2.0 LED

2x COB 6/9W | 350/500mA | 17V  
aluminium

IP20 0°-35°/355° ⚡ 34° SDCM2 L80/55K 0.61kg

wire springs 89x172-178 90 4-23

## 2.0 PAR16

2x PAR16 max. 12W | GU10  
100-240VAC | 50-60Hz  
aluminium

IP20 0°-35°/355° 0.42kg

wire springs 89x172-178 115 4-23

	CODE
White	184761W_
Black	184761B_

	CODE
White	112720W0
Black	112720B0

LIGHT COLOUR	LUMEN   CRI	CODE
2700K	2x530/715   >90	3
3000K	2x575/775   >90	5
4000K	2x620/830   >90	7
2000-3000K	2x380/560   >90	9

LED module 20 years replaceability

## ALWAYS USE

driver | 500mA | only 1x needed

	CODE
20W	90218601
20W dim	90224602
24W DALI	90244701

more options and specs on page 807

## OPTIONAL

PAR16 6.5W | GU10 | phase-cut dim

	CODE
2700K   460lm	901228W3
2700K   437lm	901228B3
3000K   500lm	901228W5
3000K   457lm	901228B5



# DEEP ADJUST trimless

Ceiling recessed



## 1.0 LED

LED COB 6,9W | 350/500mA | 17V aluminium

IP20 0°-35°/355° A-34° SDCM2 L80/55K 0.23kg

CODE
184861W_
184861G_
184861B_

LIGHT COLOUR	LUMEN CRI	CODE
2700K	530/715 >90	3
3000K	575/775 >90	5
4000K	620/830 >90	7
2000-3000K	380/560 >90	9

LED module 20 years replaceability

## ALWAYS USE

alu plasterkit 105-110 95 12,5, 15, 20, 25

CODE 90017209

driver | 500mA

CODE
10W 90214406
10W dim 90224403
24W DALI 90244701

more options and specs on page 808

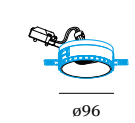

## 1.0 MR16

QR-CBC51 max. 12W | GU5.3 | 12V aluminium

IP20 0°-35°/355° 0.17kg

CODE
112810W0
112810G0
112810B0

LIGHT COLOUR	LUMEN CRI	CODE
2700K	460lm	901228W3
2700K	437lm	901228B3
3000K	500lm	901228W5
3000K	457lm	901228B5

more options and specs on page 810

## ALWAYS USE

alu plasterkit 105-110 95 12,5, 15, 20, 25

CODE 90017209

driver | 12V

CODE
10W dim 90221401
25W dim 90221701

more options and specs on page 810

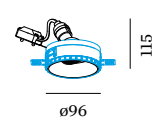

## 1.0 PAR16

PAR16 max. 12W | GU10 100-240VAC | 50-60Hz aluminium

IP20 0°-35°/355° 0.21kg

CODE
112820W0
112820G0
112820B0

LIGHT COLOUR	LUMEN CRI	CODE
2700K	460lm	901228W3
2700K	437lm	901228B3
3000K	500lm	901228W5
3000K	457lm	901228B5

more options and specs on page 810

## ALWAYS USE

alu plasterkit 105-110 120 12,5, 15, 20, 25

CODE 90017209

driver | 12V

CODE
PAR16 6.5W   GU10   phase-cut dim

more options and specs on page 810



MORE BEAM ANGLES ONLINE

weverducre.com/more-deep-adjust-trimless



HEADQUARTERS OF THE COUNCIL OF THE OCCITANIE ORDER OF ARCHITECTS | ISTHME ARCHITECTURE & URBANISME  
TOULOUSE | FRANCE



# DEEP ADJUST asym

Ceiling recessed



## 1.0 LED

LED COB 6/9W | 350/500mA | 17V  
aluminium

IP20 0°-35°/355° SDCM2 L80/55K 0.25kg

wire springs ⌀87-88 ∟110 ⚡4-25

CODE	
	1844A1W_
	1844A1S_
	1844A1G_
	1844A1B_

LIGHT COLOUR	LUMEN CRI	CODE
2700K	460/615 >90	3
3000K	495/665 >90	5
2000-3000K	330/485 >90	9

LED module 20 years replaceability

## ALWAYS USE

driver | 500mA

CODE	
10W	90214406
10W dim	90224403
24W DALI	90244701

more options and specs on page 808



## 1.0 PAR16

PAR16 max. 12W | GU10  
100-240VAC | 50-60Hz  
aluminium

IP20 0°-35°/355° 0.23kg

wire springs ⌀87-88 ∟120 ⚡4-25

CODE	
	112420W0
	112420S0
	112420G0
	112420B0

LIGHT COLOUR	LUMEN CRI	CODE
2700K   460lm		901228W3
2700K   437lm		901228B3
3000K   500lm		901228W5
3000K   457lm		901228B5

## OPTIONAL

PAR16 6.5W | GU10 | phase-cut dim

CODE	
2700K   460lm	901228W3
2700K   437lm	901228B3
3000K   500lm	901228W5
3000K   457lm	901228B5





PRIVATE RESIDENCE AUSTRIA

# DEEP ADJUST fort

Ceiling recessed

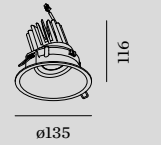
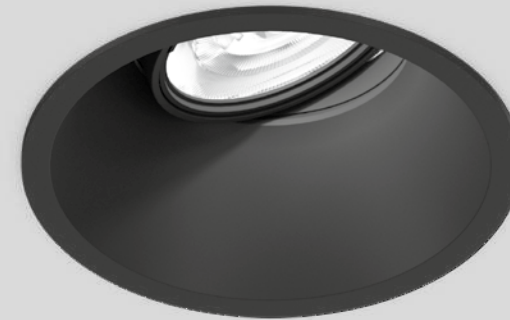

## 1.0

LED COB 25W | 700mA | 35V  
aluminium

IP20 0°-30°/355° 34° SDCM2 L80|50K 0.36kg

wire springs 126-130 130 4-25

	CODE
	112961W_
	112961B_

LIGHT COLOUR	LUMEN	CRI	CODE
3000K	2490	>90	5
4000K	2680	>90	7

LED module 20 years replaceability

## ALWAYS USE

driver | 700mA

	CODE
30W dim	90225702
28W DALI	90245704

more options and specs on page 809



PRIVATE RESIDENCE BELGIUM

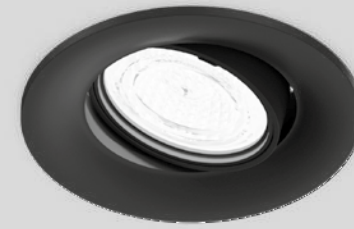

# SPINEO

Ceiling recessed

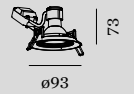

## 1.0

PAR16 max. 12W | GU10  
100-240VAC | 50-60Hz  
aluminium

IP20 0°-35°/355° 0.18kg

wire springs ⌀79-83 11.80 4-16

### CODE

160120W0
160120B0

## OPTIONAL

PAR16 6.5W | GU10 | phase-cut dim

### CODE

2700K   460lm	901228W3
2700K   437lm	901228B3
3000K   500lm	901228W5
3000K   457lm	901228B5



BLADE SPRING VERSIONS  
weverducre.com/more-spineo

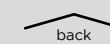



# RONY point

Ceiling recessed

new

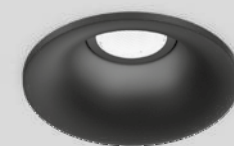

## 1.0

LED COB 5W | 250mA | 18V  
aluminium

IP20 32° SDCM2 L80|50K 0.05kg

wire springs 48-51 60 4-25

CODE

193161W\_

193161B\_

LIGHT COLOUR	LUMEN   CRI	CODE
2700K	410   >90	3
3000K	450   >90	5

## ALWAYS USE

driver | 250mA

CODE

5W dim 90226201

13W DALI\* 90246501

\*revision opening required

more options and specs on page 806

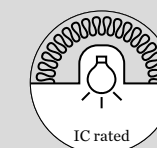

IC rated

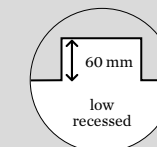

60 mm  
low  
recessed



BLADE SPRING VERSIONS ONLINE

[weverducre.com/more-rony-point](http://weverducre.com/more-rony-point)

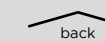

back



# RONY

Ceiling recessed

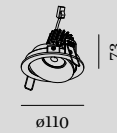

## 1.0 LED

LED COB 6/9W | 350/500mA | 17V  
aluminium

IP20 0°-35°/355° A 34° SDCM2 L80/55K 0.34kg

wire springs 102-104 90 4-25

## 1.0 PAR16

PAR16 max. 12W | GU10  
100-240VAC | 50-60Hz  
aluminium

IP20 0°-35°/355° 0.32kg

wire springs 102-104 110 4-25

CODE	
White	110261W_
Black	110261B_

LIGHT COLOUR	LUMEN   CRI	CODE
2700K	530/710 >90	3
3000K	575/770 >90	5
2000-3000K	380/560 >90	9

LED module 20 years replaceability

CODE	
White	110120W0
Black	110120B0

## ALWAYS USE

driver | 500mA

CODE	
10W	90214406
10W dim	90224403
24W DALI	90244701

more options and specs on page 808

## OPTIONAL

PAR16 6.5W | GU10 | phase-cut dim

CODE	
2700K   460lm	901228W3
2700K   437lm	901228B3
3000K   500lm	901228W5
3000K   457lm	901228B5



MORE BEAM ANGLES ONLINE

weverducre.com/more-rony



RESTAURANT GRAND CRU BRUGES | BELGIUM

# RON

Ceiling recessed

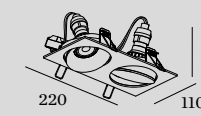
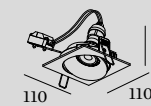
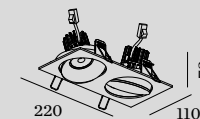
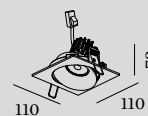

## 1.0 LED

LED COB 6/9W | 350/500mA | 17V aluminium fits in round cutout

IP20 0°-35°/355° A34° SDCM2 L80|55K 0.36kg

wire springs ⌀102-104 ⏏90 ⚡4-25

CODE

White	111461W_
Black	111461B_

LIGHT COLOUR	LUMEN CRI	CODE
2700K	530/710 >90	3
3000K	575/770 >90	5
2000-3000K	380/560 >90	9

LED module 20 years replaceability

## ALWAYS USE

driver | 500mA

	CODE
10W	90214406
10W dim	90224403
24W DALI	90244701

more options and specs on page 808

## 2.0 LED

2x COB 6/9W | 350/500mA | 17V aluminium

IP20 0°-35°/355° A34° SDCM2 L80|55K 0.73kg

wire springs ⏏102x210 ⏏90 ⚡4-25

CODE

White	111561W_
Black	111561B_

LIGHT COLOUR	LUMEN CRI	CODE
2700K	2x530/710 >90	3
3000K	2x575/770 >90	5
2000-3000K	2x380/560 >90	9

LED module 20 years replaceability

## ALWAYS USE

driver | 500mA | only 1x needed

	CODE
20W	90218601
20W dim	90224602
24W DALI	90244701

more options and specs on page 807

## 1.0 PAR16

PAR16 max. 12W | GU10 100-240VAC | 50-60Hz aluminium fits in round cutout

IP20 0°-35°/355° 0.34kg

wire springs ⌀102-104 ⏏110 ⚡4-25

CODE

White	111120W0
Black	111120B0

LIGHT COLOUR	LUMEN CRI	CODE
2700K	460lm	901228W3
2700K	437lm	901228B3
3000K	500lm	901228W5
3000K	457lm	901228B5

## OPTIONAL

PAR16 6.5W | GU10 | phase-cut dim

	CODE
2700K   460lm	901228W3
2700K   437lm	901228B3
3000K   500lm	901228W5
3000K   457lm	901228B5

## 2.0 PAR16

2x PAR16 max. 12W | GU10 100-240VAC | 50-60Hz aluminium

IP20 0°-35°/355° 0.69kg

wire springs ⏏102x210 ⏏110 ⚡4-25

CODE

White	111220W0
Black	111220B0

LIGHT COLOUR	LUMEN CRI	CODE
2700K	460lm	901228W3
2700K	437lm	901228B3
3000K	500lm	901228W5
3000K	457lm	901228B5

## OPTIONAL

PAR16 6.5W | GU10 | phase-cut dim

	CODE
2700K   460lm	901228W3
2700K   437lm	901228B3
3000K   500lm	901228W5
3000K   457lm	901228B5

FLAT 'N' FANCY

# Hidden champions

Sleek built-in luminaires are subtle, elegant, and let every room shine in the brightest light. No wonder the space-saving all-rounders are among the most popular lighting choices these days. That said, there are some requirements you'll need to consider when mounting recessed luminaires. Especially with low ceilings in modern living spaces or the lack of space in suspended ceilings, things can get really tricky – and every centimetre counts. The specially designed compact lights for low ceilings with low installation depths are not only true space savers, but also a design highlight – perfect for renovation projects and small city apartments.

<b>MATCH point 1.0 trimless</b>	p. 57	<b>60 mm</b>
<b>DEEP bijou 2.0</b>	p. 61	<b>67 mm</b>
<b>DEEP petit</b>	p. 63	<b>57 mm</b>
<b>DEEP ADJUST petit</b>	p. 69	<b>65 mm</b>
<b>RONY point</b>	p. 83	<b>60 mm</b>
<b>PIRRO petit</b>	p. 91	<b>60 mm</b>
<b>PIRRO 2.0</b>	p. 93	<b>60 mm</b>
<b>PIRRO 4.0   6.0</b>	p. 95	<b>60 mm</b>
<b>PLANO petit</b>	p. 97	<b>65 mm</b>
<b>STRANGE petit trimless</b>	p. 101	<b>65 mm</b>
<b>MATCH 2.0</b>	p. 113	<b>60 mm</b>

Schlichte Einbauleuchten halten sich optisch elegant im Hintergrund, während sie jeden Raum in seinem besten Licht erstrahlen lassen. Kein Wunder also, dass die platzsparenden Alleskönner so beliebt sind. Trotzdem: Gewisse Voraussetzungen müssen für den Einbau gegeben sein. Denn vor allem mit niedrigen Deckenhöhen in modernen Wohnräumen oder zu wenig Platz in den Zwischendecken kann es schon mal ganz schön knifflig werden – dabei zählt jeder Zentimeter. Die speziell für niedrige Räume entwickelten Leuchten mit wenig Einbautiefe sind nicht nur platzsparend, sondern vor allem auch ein echtes Designhighlight – perfekt für Renovierungsprojekte und kleine City-Apartments.

<b>MATCH 1.0 trimless</b>	p. 113	<b>67 mm</b>
<b>MATCH stick 1.0 trimless</b>	p. 117	<b>67 mm</b>
<b>CENO 2.0   3.0</b>	p. 121	<b>60 mm</b>
<b>BLIEK petit 1.0   2.0</b>	p. 123	<b>60 mm</b>
<b>DEEP petit IP65</b>	p. 139	<b>60 mm</b>
<b>RINI SNEAK IP44</b>	p. 149	<b>52 mm</b>
<b>LUNA ROUND IP44</b>	p. 151	<b>55 mm</b>
<b>LUNA SQUARE IP44</b>	p. 151	<b>52 mm</b>
<b>MIRBI IP44</b>	p. 157	<b>50 mm</b>
<b>CITY IP44</b>	p. 159	<b>50 mm</b>

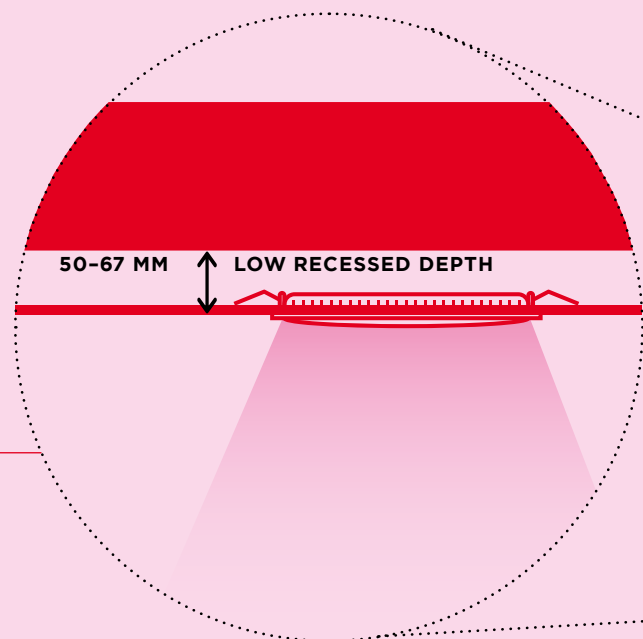

back

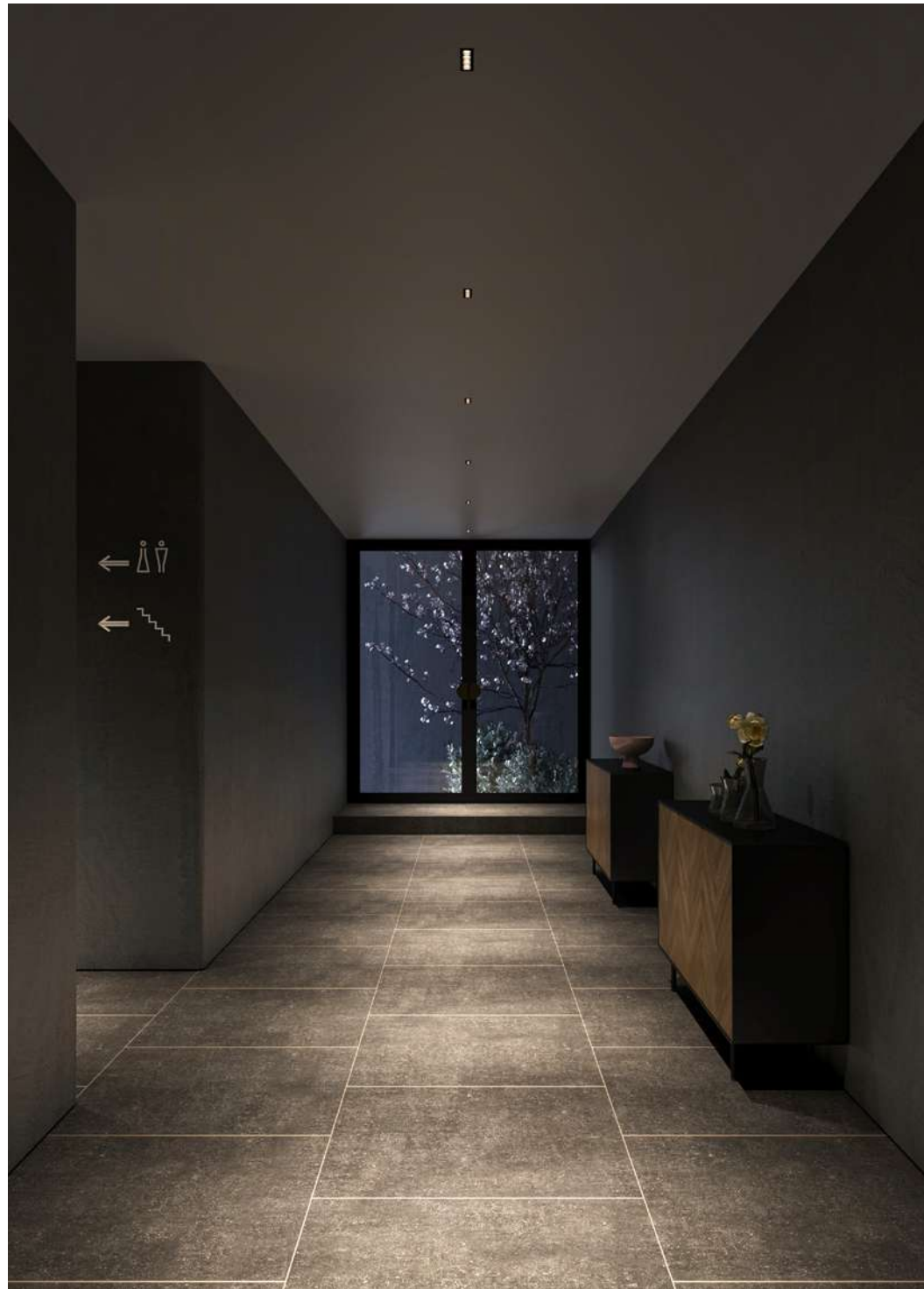

# PIRRO petit

Ceiling recessed



203



339 | 361

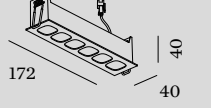
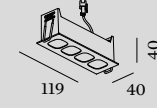
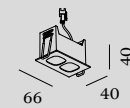
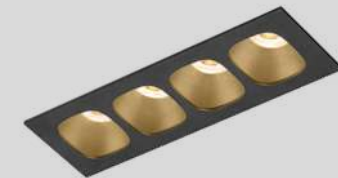
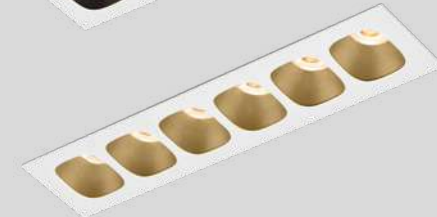

## 2.0

LED COB 4W | 350mA | 12V  
aluminium

IP20 28° SDCM3 L80|50K 0.07kg

wire springs 64x33 60 4-25

		CODE	
	129151E_		129251E_
	129151WM_		129251WM_
	129151CH_		129251CH_
	129151B_		129251B_

LIGHT COLOUR	LUMEN CRI	CODE
2700K	2x145 >90	3
3000K	2x160 >90	5

### ALWAYS USE

driver | 350mA

	CODE
4.5W dim	90223101
more options and specs on page 807	

## 4.0

LED COB 8W | 350mA | 24V  
aluminium

IP20 28° SDCM3 L80|50K 0.10kg

wire springs 116x33 60 4-25

		CODE	
	129251E_		129351E_
	129251WM_		129351WM_
	129251CH_		129351CH_
	129251B_		129351B_

LIGHT COLOUR	LUMEN CRI	CODE
2700K	4x145 >90	3
3000K	4x160 >90	5

### ALWAYS USE

driver | 350mA

	CODE
10W dim	90223406
more options and specs on page 806	

## 6.0

LED COB 12W | 350mA | 36V  
aluminium

IP20 28° SDCM3 L80|50K 0.15kg

wire springs 168x33 60 4-25

		CODE	
	129351E_		129351E_
	129351WM_		129351WM_
	129351CH_		129351CH_
	129351B_		129351B_

LIGHT COLOUR	LUMEN CRI	CODE
2700K	6x145 >90	3
3000K	6x160 >90	5

### ALWAYS USE

driver | 350mA

	CODE
13W dim	90223404
more options and specs on page 807	

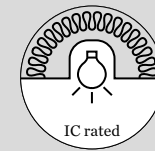
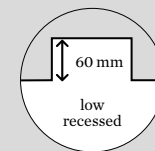



PRIVATE RESIDENCE | STUDIO GLYN UNITED KINGDOM

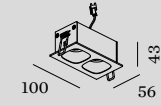
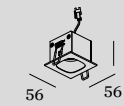

**1.0**

LED COB 5W | 500mA | 9V  
aluminium

IP20 32° SDCM2 L70|55K 0.09kg

wire springs 50x50 85 4-25

	CODE
	150161E_
	150161J_
	150161K_
	150161B_

LIGHT COLOUR	LUMEN CRI	CODE
2700K	400 >90	3
3000K	420 >90	5

**ALWAYS USE**

driver | 500mA

	CODE
6.5W dim	90224301
24W DALI	90244701

more options and specs on page 808

**2.0**

LED COB 9W | 500mA | 18V  
aluminium

IP20 32° SDCM2 L70|55K 0.16kg

wire springs 95x50 60 4-25

	CODE
	150261E_
	150261J_
	150261K_
	150261B_

LIGHT COLOUR	LUMEN CRI	CODE
2700K	2x400 >90	3
3000K	2x420 >90	5

**ALWAYS USE**

driver | 500mA | only 1x needed

	CODE
10W dim	90224403
24W DALI	90244701

more options and specs on page 808

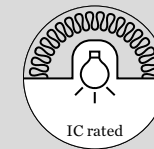
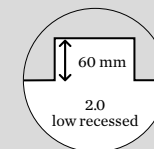

PIRRO

Ceiling recessed



As awarded by The Chicago Athenaeum: Museum of Architecture and Design



205



339 | 361



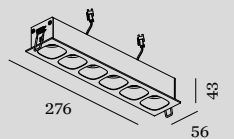
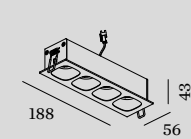
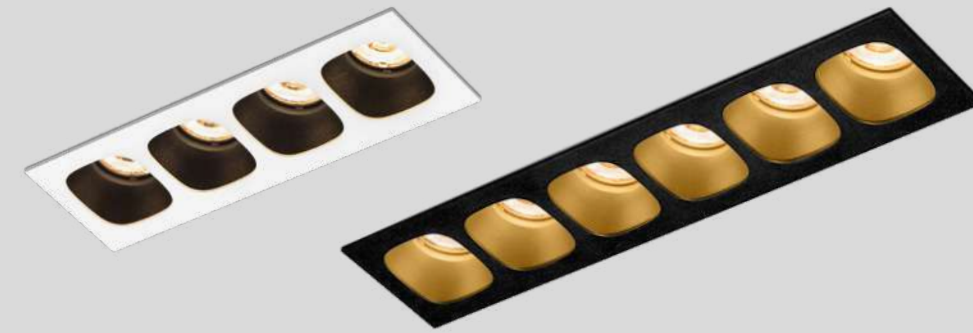

**4.0**

LED COB 17W | 500mA | 36V  
aluminium

IP20 32° SDCM2 L70|55K 0.28kg

wire springs 181x50 1.60 4-25

CODE	
	150461E_
	150461J_
	150461K_
	150461B_

LIGHT COLOUR	LUMEN CRI	CODE
2700K	4x400   >90	3
3000K	4x420   >90	5

**ALWAYS USE**

driver | 500mA | only 1x needed

CODE	
20W dim	90224602
24W DALI	90244701

more options and specs on page 808

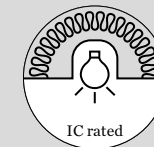
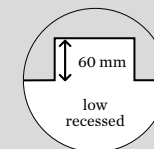

**PIRRO**

Ceiling recessed



As awarded by The Chicago Athenaeum: Museum of Architecture and Design



205



339 | 361

**6.0**

LED COB 25W | 500mA | 2x27V  
aluminium

IP20 32° SDCM2 L70|55K 0.40kg

wire springs 269x50 1.60 4-25

CODE	
	150661E_
	150661J_
	150661K_
	150661B_

LIGHT COLOUR	LUMEN CRI	CODE
2700K	6x400   >90	3
3000K	6x420   >90	5

**ALWAYS USE**

driver | 500mA | 2x needed

CODE	
20W dim	90224602
24W DALI	90244701

more options and specs on page 808



# PLANO petit

Ceiling recessed

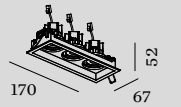
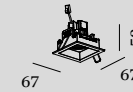
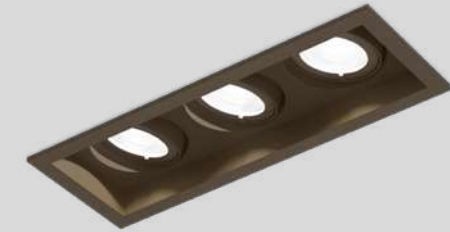

## 1.0

LED COB 6W | 350mA | 17V  
aluminium

IP20 0°-25°|355° 31° SDCM2 L70|55K 0.08kg

wire springs 54x59 65 2-22

## 2.0

2x LED COB 6W | 350mA | 17V  
aluminium

IP20 0°-25°|355° 31° SDCM2 L70|55K 0.15kg

wire springs 54x110 65 2-22

## 3.0

3x LED COB 6W | 350mA | 17V  
aluminium

IP20 0°-25°|355° 31° SDCM2 L70|55K 0.22kg

wire springs 54x162 65 2-22

CODE	
	162461W_
	162461Q_
	162461B_

LIGHT COLOUR	LUMEN CRI	CODE
2700K	540 >90	3
3000K	570 >90	5
2000-3000K   16V	440 >90	9

LED module 20 years replaceability

### ALWAYS USE

driver | 350mA

CODE	
6W	90213303
10W dim	90223406
14W DALI	90243501

more options and specs on page 806

CODE	
	162561W_
	162561Q_
	162561B_

LIGHT COLOUR	LUMEN CRI	CODE
2700K	2x540 >90	3
3000K	2x570 >90	5
2000-3000K   16V	2x440 >90	9

LED module 20 years replaceability

### ALWAYS USE

driver | 350mA | only 1x needed

CODE	
17.5W	90218601
13W dim	90223404
14W DALI	90243501

more options and specs on page 807

CODE	
	162661W_
	162661Q_
	162661B_

LIGHT COLOUR	LUMEN CRI	CODE
2700K	3x540 >90	3
3000K	3x570 >90	5
2000-3000K   16V	3x440 >90	9

LED module 20 years replaceability

### ALWAYS USE

driver | 350mA | 3x needed

CODE	
6W	90213303
10W dim	90223406
14W DALI	90243501

more options and specs on page 806

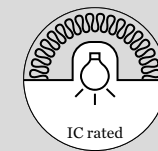
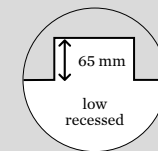

MORE BEAM ANGLES ONLINE

[weverducre.com/more-plano-petit](http://weverducre.com/more-plano-petit)



# PLANO

Ceiling recessed

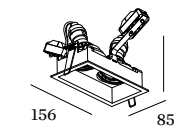
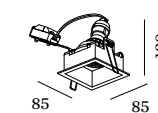
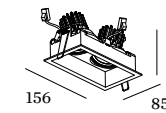
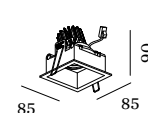
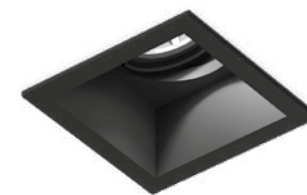

## 1.0 LED

LED COB 6/9W | 350/500mA | 17V aluminium

IP20 0°-35°|355° A 34° SDCM2 L80|55K 0.26kg

wire springs 74x78 11.95 2-18

	CODE
	118561W_
	118561S_
	118561Q_
	118561B_

LIGHT COLOUR	LUMEN	CRI	CODE
2700K	510/685	>90	3
3000K	550/740	>90	5
2000-3000K	365/535	>90	9

LED module 20 years replaceability

## ALWAYS USE

driver | 500mA

	CODE
10W	90214406
10W dim	90224403
24W DALI	90244701

more options and specs on page 808

## 2.0 LED

2x COB 6/9W | 350/500mA | 17V aluminium

IP20 0°-35°|355° A 34° SDCM2 L80|55K 0.48kg

wire springs 74x148 11.95 2-18

	CODE
	118661W_
	118661S_
	118661Q_
	118661B_

LIGHT COLOUR	LUMEN	CRI	CODE
2700K	2x510/685	>90	3
3000K	2x550/740	>90	5
2000-3000K	2x365/535	>90	9

LED module 20 years replaceability

## ALWAYS USE

driver | 500mA | only 1x needed

	CODE
20W	90218601
20W dim	90224602
24W DALI	90244701

more options and specs on page 807

## 1.0 PAR16

PAR16 max. 12W | GU10 100-240VAC | 50-60Hz aluminium

IP20 0°-35°|355° 0.24kg

wire springs 74x78 11.125 2-18

	CODE
	118120W0
	118120S0
	118120Q0
	118120B0

LIGHT COLOUR	LUMEN	CRI	CODE
2700K	460lm	>90	3
2700K	437lm	>90	5
3000K	500lm	>90	9
3000K	457lm	>90	9

LED module 20 years replaceability

## OPTIONAL

PAR16 6.5W | GU10 | phase-cut dim

	CODE
2700K   460lm	901228W3
2700K   437lm	901228B3
3000K   500lm	901228W5
3000K   457lm	901228B5

## 2.0 PAR16

2x PAR16 max. 12W | GU10 100-240VAC | 50-60Hz aluminium

IP20 0°-35°|355° 0.44kg

wire springs 74x148 11.125 2-18

	CODE
	118220W0
	118220S0
	118220Q0
	118220B0

LIGHT COLOUR	LUMEN	CRI	CODE
2700K	460lm	>90	3
2700K	437lm	>90	5
3000K	500lm	>90	9
3000K	457lm	>90	9

LED module 20 years replaceability

## OPTIONAL

PAR16 6.5W | GU10 | phase-cut dim

	CODE
2700K   460lm	901228W3
2700K   437lm	901228B3
3000K   500lm	901228W5
3000K   457lm	901228B5



# STRANGE petit trimless

Ceiling recessed

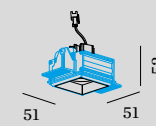
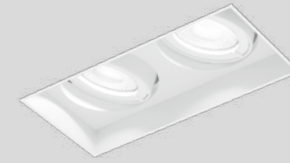
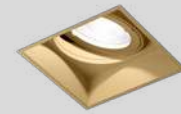

## 1.0

LED COB 6W | 350mA | 17V  
aluminium

IP20 0°-25°|355° 31° SDCM2 L80|55K 0.07kg

CODE	
	163461W_
	163461M_
	163461B_

LIGHT COLOUR	LUMEN CRI	CODE
2700K	540 >90	3
3000K	570 >90	5
2000-3000K	440 >90	9

LED module 20 years replaceability

### ALWAYS USE

alu plasterkit 64x64 65 7-32

CODE	
	90017202

driver | 350mA

CODE	
6W	90213303
10W dim	90223406
14W DALI	90243501

more options and specs on page 806

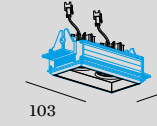

## 2.0

2x LED COB 6W | 350mA | 17V  
aluminium

IP20 0°-25°|355° 31° SDCM2 L80|55K 0.13kg

CODE	
	163561W_
	163561M_
	163561B_

LIGHT COLOUR	LUMEN CRI	CODE
2700K	2x540 >90	3
3000K	2x570 >90	5
2000-3000K	2x440 >90	9

LED module 20 years replaceability

### ALWAYS USE

alu plasterkit 64x117 65 7-32

CODE	
	90017205

driver | 350mA | only 1x needed

CODE	
17.5W	90218601
13W dim	90223404
14W DALI	90243501

more options and specs on page 807

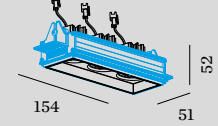

## 3.0

3x LED COB 6W | 350mA | 17V  
aluminium

IP20 0°-25°|355° 31° SDCM2 L80|55K 0.19kg

CODE	
	163661W_
	163661M_
	163661B_

LIGHT COLOUR	LUMEN CRI	CODE
2700K	3x540 >90	3
3000K	3x570 >90	5
2000-3000K	3x440 >90	9

LED module 20 years replaceability

### ALWAYS USE

alu plasterkit 64x169 65 7-32

CODE	
	90017208

driver | 350mA | 3x needed

CODE	
6W	90213303
10W dim	90223406
14W DALI	90243501

more options and specs on page 806

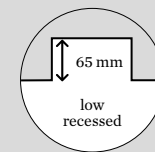



# STRANGE trimless

Ceiling recessed

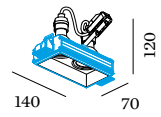
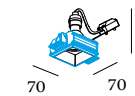
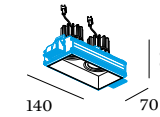
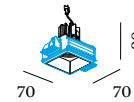
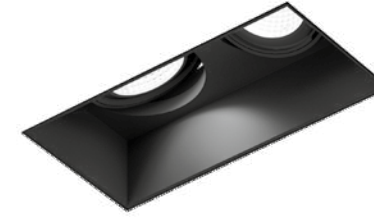

## 1.0 LED

LED COB 6/9W | 350/500mA | 17V aluminium

IP20 0°-35°/355° 34° SDCM2 L80/55K 0.43kg

CODE
131461W_
131461M_
131461B_

LIGHT COLOUR	LUMEN	CRI	CODE
2700K	510/685	>90	3
3000K	550/740	>90	5
2000-3000K	365/535	>90	9

LED module 20 years replaceability

## ALWAYS USE

alu plasterkit 86x86 11.95 7-32

CODE
90017120

driver | 500mA

	CODE
10W	90214406
10W dim	90224403
24W DALI	90244701

more options and specs on page 808

## 2.0 LED

2x COB 6/9W | 350/500mA | 17V aluminium

IP20 0°-35°/355° 34° SDCM2 L80/55K 0.74kg

CODE
131561W_
131561M_
131561B_

LIGHT COLOUR	LUMEN	CRI	CODE
2700K	2x510/685	>90	3
3000K	2x550/740	>90	5
2000-3000K	2x365/535	>90	9

LED module 20 years replaceability

## ALWAYS USE

alu plasterkit 86x156 11.95 7-32

CODE
90017121

driver | 500mA | only 1x needed

	CODE
20W	90218601
20W dim	90224602
24W DALI	90244701

more options and specs on page 807

## 1.0 PAR16

PAR16 max. 12W | GU10 100-240VAC | 50-60Hz aluminium

IP20 0°-35°/355° 0.41kg

CODE
131120W0
131120M0
131120B0

## ALWAYS USE

alu plasterkit 86x86 11.125 7-32

CODE
90017120

## OPTIONAL

PAR16 6.5W | GU10 | phase-cut dim

	CODE
2700K   460lm	901228W3
2700K   437lm	901228B3
3000K   500lm	901228W5
3000K   457lm	901228B5

## 2.0 PAR16

2x PAR16 max. 12W | GU10 100-240VAC | 50-60Hz aluminium

IP20 0°-35°/355° 0.70kg

CODE
131220W0
131220M0
131220B0

## ALWAYS USE

alu plasterkit 86x156 11.125 7-32

CODE
90017121

## OPTIONAL

PAR16 6.5W | GU10 | phase-cut dim

	CODE
2700K   460lm	901228W3
2700K   437lm	901228B3
3000K   500lm	901228W5
3000K   457lm	901228B5



# SNEAK

Ceiling recessed

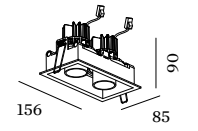
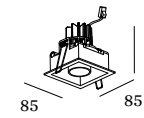
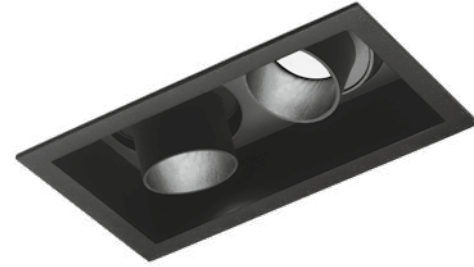

## 1.0

LED COB 6/9W | 350/500mA | 17V aluminium

IP20 0°-35°/355° A30° SDCM2 L80/55K 0.19kg

wire springs 74x78 95 2-18

## 2.0

2x COB 6/9W | 350/500mA | 17V aluminium

IP20 0°-35°/355° A30° SDCM2 L80/55K 0.34kg

wire springs 74x148 95 2-18

	CODE
	155751W_
	155751K_
	155751B_

LIGHT COLOUR	LUMEN	CRI	CODE
2700K	340/460	>90	3
3000K	360/485	>90	5
2000-3000K	250/370	>90	9

LED module 20 years replaceability

### ALWAYS USE

driver | 500mA

	CODE
10W	90214406
10W dim	90224403
24W DALI	90244701

more options and specs on page 808

	CODE
	155851W_
	155851K_
	155851B_

LIGHT COLOUR	LUMEN	CRI	CODE
2700K	2x340/460	>90	3
3000K	2x360/485	>90	5
2000-3000K	2x250/370	>90	9

LED module 20 years replaceability

### ALWAYS USE

driver | 500mA | only 1x needed

	CODE
20W	90218601
20W dim	90224602
24W DALI	90244701

more options and specs on page 807



PRIVATE RESIDENCE | STUDIO BENOIT BELGIUM

# SNEAK trimless

Ceiling recessed

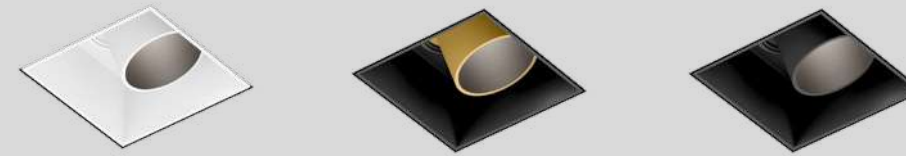

## 1.0

LED LED COB 6/9W | 350/500mA | 17V aluminium

IP20 0°-35°/355° A 30° SDCM2 L80|55K 0.19kg

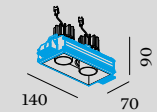

## 2.0

LED 2x COB 6/9W | 350/500mA | 17V aluminium

IP20 0°-35°/355° A 30° SDCM2 L80|55K 0.34kg

CODE	
	155551W_
	155551K_
	155551B_

LIGHT COLOUR	LUMEN	CRI	CODE
2700K	340/460	>90 3	
3000K	360/485	>90 5	
2000-3000K	250/370	>90 9	

LED module 20 years replaceability

### ALWAYS USE

alu plasterkit 86x86 1.95 7-32

CODE	
	90017120

driver | 500mA

CODE	
10W	90214406
10W dim	90224403
24W DALI	90244701

more options and specs on page 808

CODE	
	155651W_
	155651K_
	155651B_

LIGHT COLOUR	LUMEN	CRI	CODE
2700K	2x340/460	>90 3	
3000K	2x360/485	>90 5	
2000-3000K	2x250/370	>90 9	

LED module 20 years replaceability

### ALWAYS USE

alu plasterkit 86x156 1.95 7-32

CODE	
	90017121

driver | 500mA | only 1x needed

CODE	
20W	90218601
20W dim	90224602
24W DALI	90244701

more options and specs on page 807



# LECA

Ceiling recessed

new



221

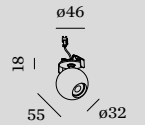

## 1.0

LED COB 6W | 350mA | 18V  
aluminium

IP20 0°-90°/350° A 31° SDCM2 L70/55K 0.32kg

wire springs ⌀40-41 1.68 4-26

2700K | CRI >90 | 510lm

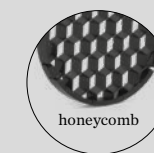
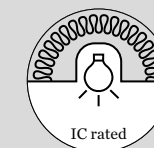

## OPTIONAL

honeycomb louver



CODE  
90051131

CODE

188161W3

188161Q3

188161B3

## ALWAYS USE

driver | 350mA

CODE

7W dim 90223301

14W DALI\* 90243501

\*revision opening required

more options and specs on page 806

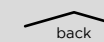





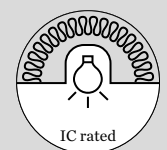
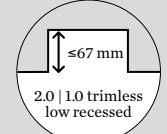

**BLADE SPRING VERSIONS ONLINE**  
[weverducre.com/more-match-recessed](http://weverducre.com/more-match-recessed)

# MATCH

Ceiling recessed



reddot winner 2023



As awarded by The Chicago Athenaeum: Museum of Architecture and Design

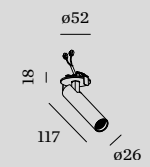
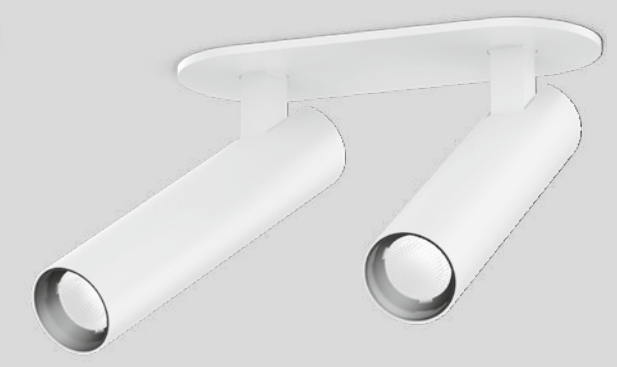

## 1.0

LED COB 6W | 350mA | 18V  
aluminium

IP20 0°-90°/350° ▲30° SDCM2 L80|50K 0.16kg

wire springs ⌀45-47 ⏏85 ⚡4-26

CODE	
	190151W_
	190151BL_
	190151CH_
	190151B_

LIGHT COLOUR	LUMEN CRI	CODE
2700K	2x535 >90	3
3000K	2x560 >90	5

### ALWAYS USE

driver | 350mA

CODE	
6W	90213303
7W dim	90223301
14W DALI*	90243501

\*revision opening required  
 more options and specs on page 806

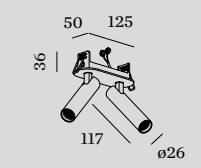

## 2.0

2x LED COB 6W | 700mA | 18V  
aluminium

IP20 0°-90°/350° ▲30° SDCM2 L80|50K 0.27kg

wire springs 105x30 ⏏60 ⚡4-26

CODE	
	190251W_
	190251B_

LIGHT COLOUR	LUMEN CRI	CODE
2700K	2x535 >90	3
3000K	2x560 >90	5

### ALWAYS USE

driver | 700mA | only 1x needed

CODE	
15W dim	90225502
28W DALI	90245704

more options and specs on page 809

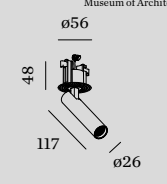

## 1.0 TRIMLESS

LED COB 6W | 350mA | 18V  
aluminium

IP20 0°-90°/360° ▲30° SDCM2 L80|50K 0.15kg

wire springs ⌀45-47 ⏏67 ⚡4-26

CODE	
	190851W_
	190851BL_
	190851B_

LIGHT COLOUR	LUMEN CRI	CODE
2700K	535 >90	3
3000K	560 >90	5

### ALWAYS USE

driver | 350mA

CODE	
6W	90213303
7W dim	90223301
14W DALI	90243501

revision opening required  
 more options and specs on page 806





# MATCH stick

Ceiling recessed



reddot winner 2023



223



As awarded by The Chicago Athenaeum:  
Museum of Architecture and Design

307 | 321



407

## 1.0 TRIMLESS

LED COB 6W | 350mA | 18V  
aluminium

515 | 623

IP20 0°-90°/360° A 30° SDCM2 L80/50K 0.37kg

45-47 67 4-26

659

### CODE

	190951W_
	190951BL_
	190951B_

LIGHT COLOUR	LUMEN CRI	CODE
2700K	535 >90	3
3000K	560 >90	5

## ALWAYS USE

driver | 350mA

### CODE

6W	90213303
7W dim	90223301
14W DALI	90243501

revision opening required  
more options and specs on page 806

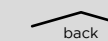
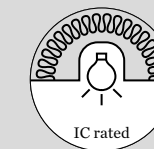
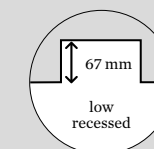



# CENO

Ceiling recessed



## 1.0 SEMI RECESSED

LED COB 6W | 350mA | 17V  
aluminium

IP20 0°-90°/350° A 31° SDCM2 L70|55K 0.14kg

CODE
176561W_
176561B_

LIGHT COLOUR	LUMEN CRI	CODE
2700K	470 >90	3
3000K	500 >90	5

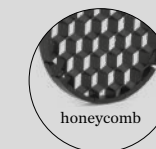
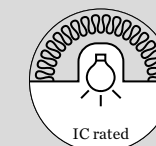

### OPTIONAL

honeycomb louver

CODE
90051131

### ALWAYS USE

driver | 350mA

CODE
6W
7W dim
14W DALI*

more options and specs on page 806



## 1.0

LED COB 6W | 350mA | 17V  
aluminium

IP20 0°-90°/350° A 31° SDCM2 L70|55K 0.12kg

wire springs 45-47 1.85 4-26

CODE
176161W_
176161G_
176161Q_
176161K_
176161CH_
176161B_

LIGHT COLOUR	LUMEN CRI	CODE
2700K	470 >90	3
3000K	500 >90	5
2000-3000K   16V	355 >90	9

blade springs 46-48 1.85 min. 8

CODE
176161W_C
176161Q_C
176161B_C

LIGHT COLOUR	LUMEN CRI	CODE
2700K	470 >90	3
3000K	500 >90	5
2000-3000K   16V	355 >90	9

### ALWAYS USE

driver | 350mA

CODE
6W
7W dim
14W DALI*

\*revision opening required  
more options and specs on page 806

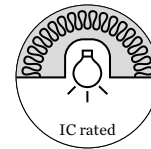
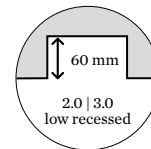
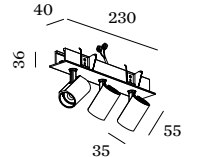
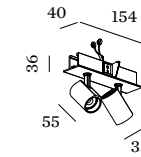
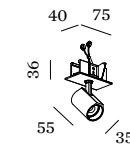

**OPTIONAL**

honeycomb louver

CODE	90051131
------	----------

**1.1**

LED COB 6W | 350mA | 17V  
aluminium

IP20 0°-90°/350° A 31° SDCM2 L70/55K 0.13kg

blade springs 32x66 85 min. 4

CODE
176461W_
176461Q_
176461K_
176461B_

LIGHT COLOUR	LUMEN CRI	CODE
2700K	470 >90	3
3000K	500 >90	5

**ALWAYS USE**

driver | 350mA

CODE
6W 90213303
7W dim 90223301
14W DALI 90243501

more options and specs on page 806

**2.0**

2x LED COB 6W | 700mA | 17V  
aluminium

IP20 0°-90°/350° A 31° SDCM2 L70/55K 0.26kg

blade springs 32x145 60 min. 4

CODE
176261W_
176261Q_
176261K_
176261B_

LIGHT COLOUR	LUMEN CRI	CODE
2700K	2x470 >90	3
3000K	2x500 >90	5

**ALWAYS USE**

driver | 700mA | only 1x needed

CODE
15W dim 90225502
28W DALI 90245704

more options and specs on page 809

**3.0**

3x LED COB 6W | 700mA | 26V  
aluminium

IP20 0°-90°/350° A 31° SDCM2 L70/55K 0.39kg

blade springs 32x221 60 min. 4

CODE
176361W_
176361Q_
176361K_
176361B_

LIGHT COLOUR	LUMEN CRI	CODE
2700K	3x470 >90	3
3000K	3x500 >90	5

**ALWAYS USE**

driver | 700mA | only 1x needed

CODE
20W dim 90225604
28W DALI 90245704

more options and specs on page 809

**CENO**

Ceiling recessed



227



303 | 353



513

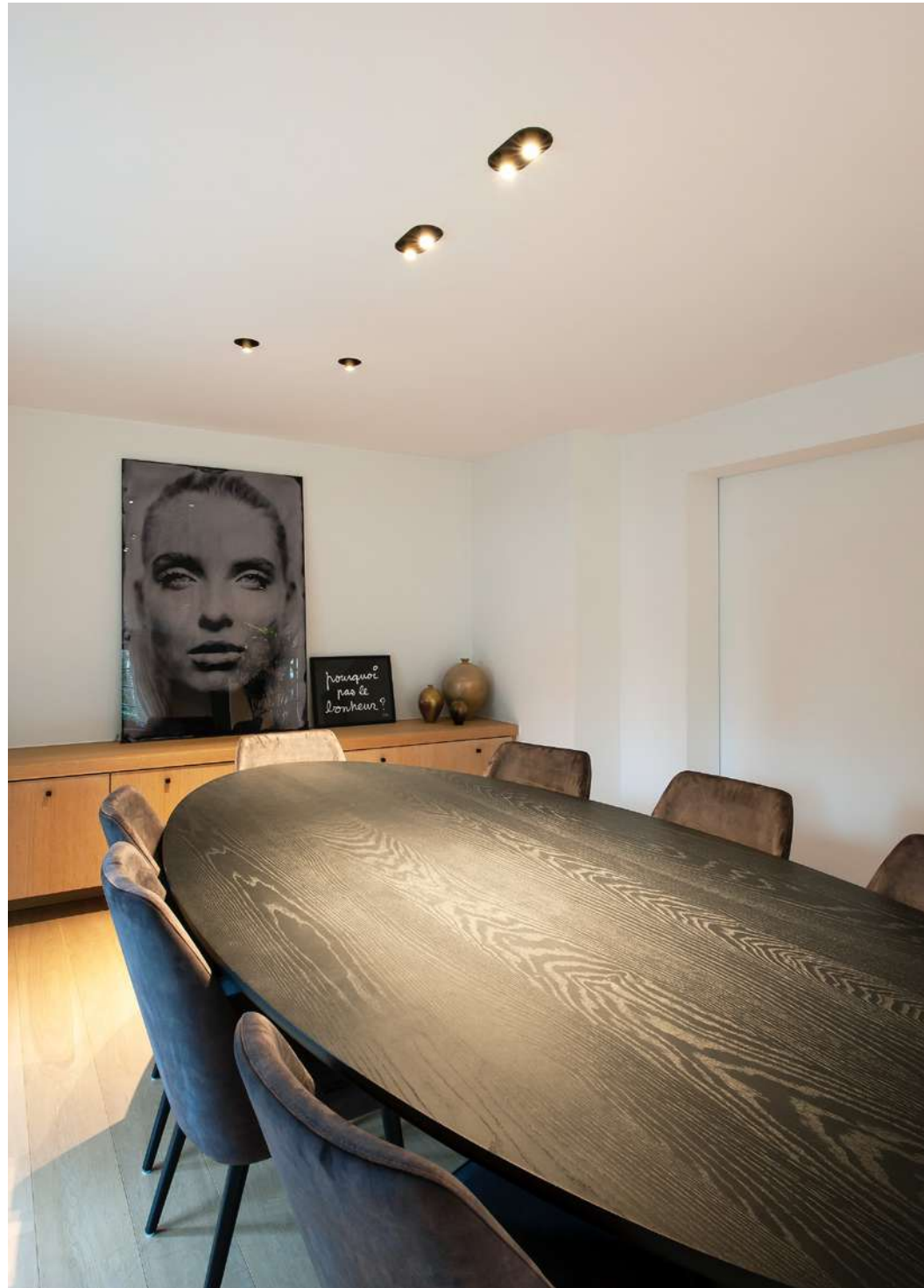

# BLIEK petit

Ceiling recessed

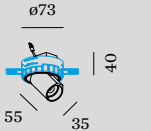
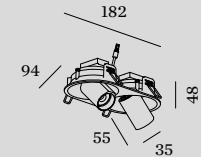
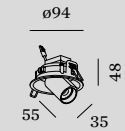

## 1.0

LED COB 6W | 350mA | 17V  
aluminium

IP20 0°-60°/355° A 31° SDCM2 L70|55K 0.20kg

wire springs 86-89 60 4-23

## 2.0

2x LED COB 6W | 700mA | 17V  
aluminium

IP20 0°-60°/355° A 31° SDCM2 L70|55K 0.40kg

wire springs 87x176 60 4-23

## 1.0 TRIMLESS

LED COB 6W | 350mA | 17V  
aluminium

IP20 0°-60°/355° A 31° SDCM2 L70|55K 0.17kg

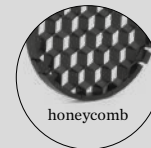
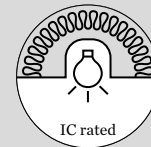
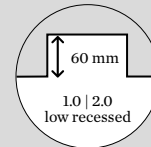

### OPTIONAL

honeycomb louver

CODE 90051131

CODE
164461W_
164461CH_
164461B_

LIGHT COLOUR	LUMEN	CRI	CODE
2700K	470	>90	3
3000K	500	>90	5
2000-3000K   16V	355	>90	9

### ALWAYS USE

driver | 350mA

CODE
90213303
90223406
90243501

more options and specs on page 806

CODE
164261W_
164261CH_
164261B_

LIGHT COLOUR	LUMEN	CRI	CODE
2700K	2x470	>90	3
3000K	2x500	>90	5

### ALWAYS USE

driver | 700mA | only 1x needed

CODE
90225502
90245704

more options and specs on page 809

CODE
164561W_
164561CH_
164561B_

LIGHT COLOUR	LUMEN	CRI	CODE
2700K	470	>90	3
3000K	500	>90	5
2000-3000K   16V	355	>90	9

### ALWAYS USE

alu plasterkit 78-80 80 12,5, 15, 20, 25  
CODE

90017210

driver | 350mA

CODE
90213303
90223406
90243501

more options and specs on page 806







APARTMENT RONDA SANT PERE | DANIEL NASSAR | ALSINASECH LIGHTING PROJECT SPAIN

# BLIEK ROUND

Ceiling recessed



## 1.0 LED

LED COB 6/9W | 350/500mA | 17V aluminium

IP20 0°-60°/355° A 33° SDCM2 L80/55K 0.45kg

wire springs  $\varnothing 127$   $\perp 1.75$   $\approx 4-25$

	CODE
	125361W_
	125361K_
	125361B_

LIGHT COLOUR	LUMEN	CRI	CODE
2700K	480/640	>90	3
3000K	490/650	>90	5
4000K	500/670	>90	7
2000-3000K	350/500	>90	9

LED module 20 years replaceability

## ALWAYS USE

driver | 500mA

	CODE
10W	90214406
10W dim	90224403
24W DALI	90244701

more options and specs on page 808

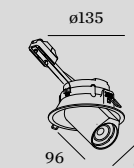

## 1.0 PAR16

PAR16 max. 12W | GU10 100-240VAC | 50-60Hz aluminium

IP20 0°-60°/350° 0.42kg

wire springs  $\varnothing 127$   $\perp 1.75$   $\approx 4-25$

	CODE
	125120W0
	125120K0
	125120B0

## OPTIONAL

PAR16 6.5W | GU10 | phase-cut dim

	CODE
2700K   460lm	901228W3
2700K   437lm	901228B3
3000K   500lm	901228W5
3000K   457lm	901228B5



BLADE SPRING VERSIONS AND MORE BEAM ANGLES ONLINE

[weverducre.com/more-bliek-round](http://weverducre.com/more-bliek-round)

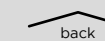
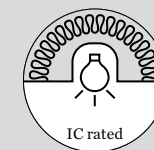

back

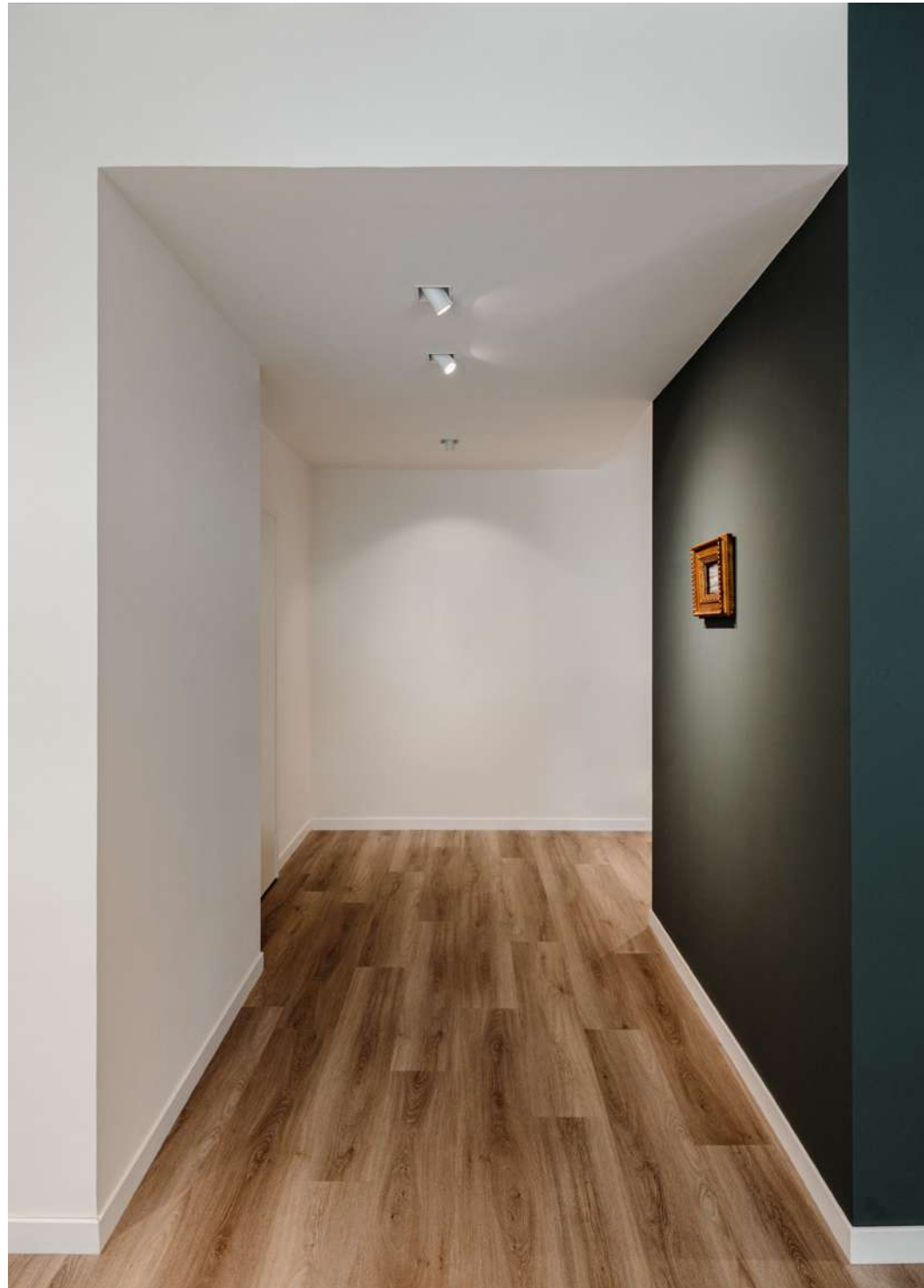

# BLIEK SQUARE

Ceiling recessed

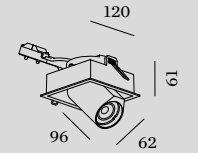
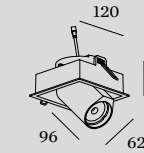

## 1.0 LED

LED COB 6/9W | 350/500mA | 17V aluminium

IP20 0°-60°/355° -A-33° SDCM2 L80/55K 0.47kg

wire springs 111x111 75 4-25

	CODE
	125461W_
	125461B_

LIGHT COLOUR	LUMEN	CRI	CODE
2700K	480/640	>90	3
3000K	490/650	>90	5
4000K	500/670	>90	7
2000-3000K	350/500	>90	9

LED module 20 years replaceability

## ALWAYS USE

driver | 500mA

	CODE
10W	90214406
10W dim	90224403
24W DALI	90244701

more options and specs on page 808

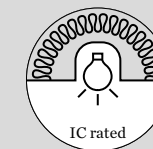

## 1.0 PAR16

PAR16 max. 12W | GU10 100-240VAC | 50-60Hz aluminium

IP20 0°-60°/350° 0.45kg

wire springs 111x111 75 4-25

	CODE
	125220W0
	125220B0

## OPTIONAL

PAR16 6.5W | GU10 | phase-cut dim

	CODE
2700K   460lm	901228W3
2700K   437lm	901228B3
3000K   500lm	901228W5
3000K   457lm	901228B5

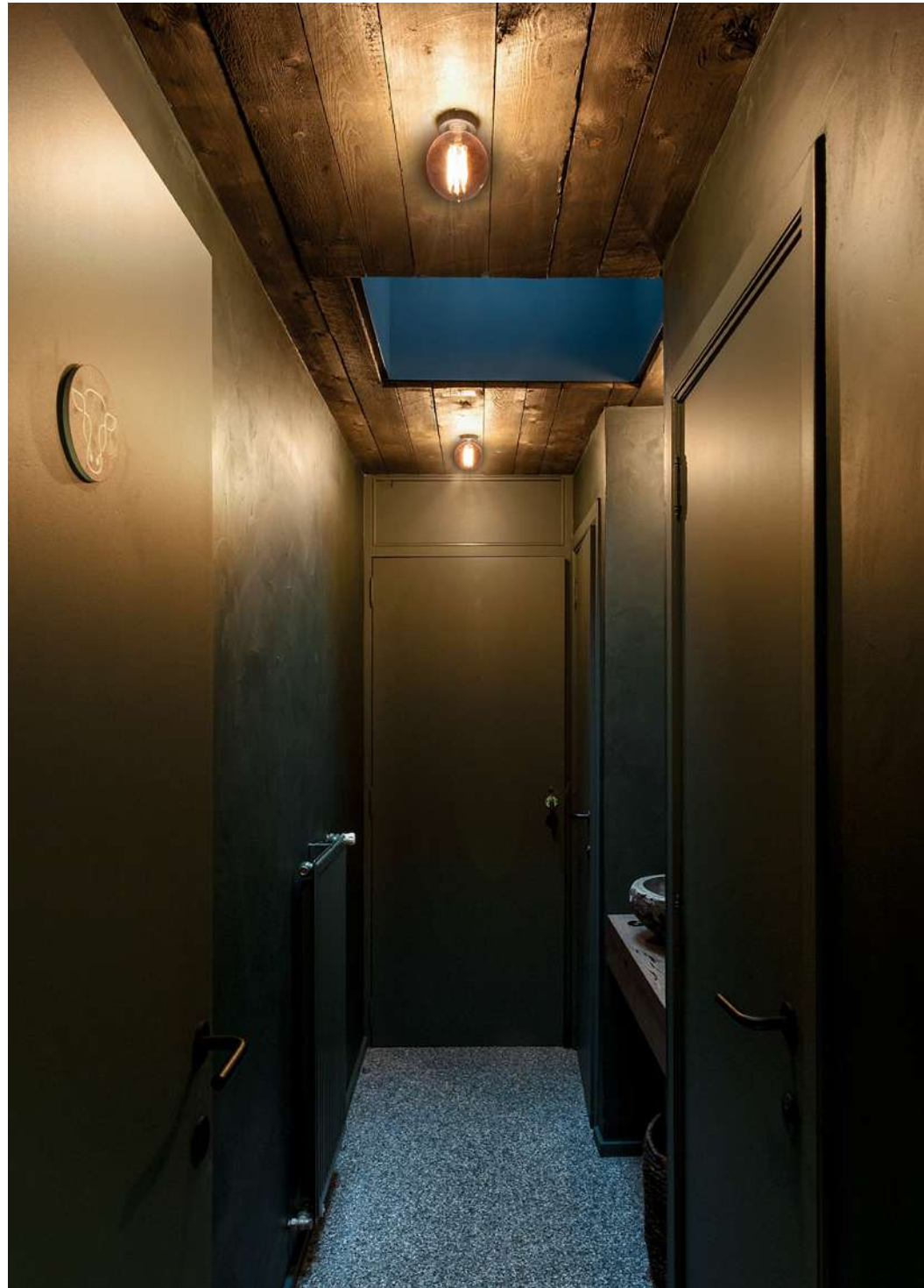

EETCAFÉ DEN OS | MARKEY & SCHELSTRAETE NUKERKE | BELGIUM



# RUVI

Ceiling recessed

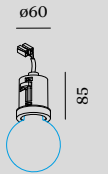

## 1.0

G95 max. 12W | E27  
220-240VAC | 50-60Hz  
aluminium

IP20 0.25kg

54-56 JTL90 7-33

CODE

1671E0B0

## OPTIONAL

G95 5.6W | E27 | phase-cut dim  
filament | gold mirror

CODE

2700K | 464lm 9003E142

G95 5.1W | E27 | phase-cut dim  
filament | gold mirror

CODE

2200K | 371lm 9003E156

G95 5.6W | E27 | phase-cut dim  
filament | silver mirror

CODE

2700K | 464lm 9003E157

G95 5.4W | E27 | phase-cut dim  
filament | gold tinted

CODE

2200K | 380lm 9003E111

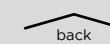

SCARED OF WATER? NO WAY!

## They're *fun* to bathe with

Keep knocking on the bathroom door all you want, IP44 luminaires will be in no hurry to leave, even less so with IP65. Luminaires with the IP44 certification are protected against splashes and those with IP65 are resistant to water jets. They're every bit as comfortable in a SPA as they are above a shower. Don't have much space? Then choose a version with a low installation depth. They fit well in rooms with low ceiling heights as well, making even the smallest hotel bathrooms shine. By the way, many types of IP44 or IP65 luminaires are not only available as spots but in many more varieties, too.

<b>DEEP point IP44</b>	p. 135
<b>DEEP bijou IP65</b>	p. 137
<b>DEEP petit IP65</b>	p. 139
<b>DEEP IP65   IP44</b>	p. 141
<b>DEEPER IP44</b>	p. 143
<b>MATCH point IP44</b>	p. 145
<b>TAIO IP65</b>	p. 147
<b>RINI SNEAK IP44</b>	p. 149
<b>LUNA ROUND IP44</b>	p. 151
<b>LUNA SQUARE IP44</b>	p. 151
<b>PLANO IP44</b>	p. 153
<b>PERLEZ IP44</b>	p. 155
<b>MIRBI IP44</b>	p. 157
<b>CITY IP44</b>	p. 159

Eines ist sicher: Bei IP44-Leuchten kann man lange an die Badezimmertür klopfen – die kommen nicht raus. Bei IP65-Leuchten noch länger. Schließlich sind Leuchten mit der Zertifizierung IP44 optimal vor Spritzwasser und mit IP65 sogar vor einem Wasserstrahl geschützt. Und fühlen sich daher im SPA-Bereich genau so wohl, wie über der Dusche. Sie haben nur wenig Platz? Dann sind Versionen mit geringer Einbautiefe die perfekte Lösung. Sie passen auch in Räume mit geringer Raumhöhe und bringen so selbst das kleinste Hotelbadezimmer zum Strahlen. Übrigens: IP44- oder IP65-Leuchten sind natürlich nicht nur als Spots, sondern auch in vielen anderen Ausführungen erhältlich.

<b>PERLEZ IP44</b>	p. 279
<b>TAIO IP65</b>	p. 281
<b>MIRBI IP44</b>	p. 283
<b>ROB IP44</b>	p. 285
<b>ROBY IP44</b>	p. 287
<b>TOWNA IP44</b>	p. 289
<b>PERLEZ IP44</b>	p. 635
<b>PERLEZ CLIP IP44</b>	p. 637
<b>RUVI IP44</b>	p. 639
<b>MIRBA IP44</b>	p. 641
<b>MIRBI LONG IP44</b>	p. 643

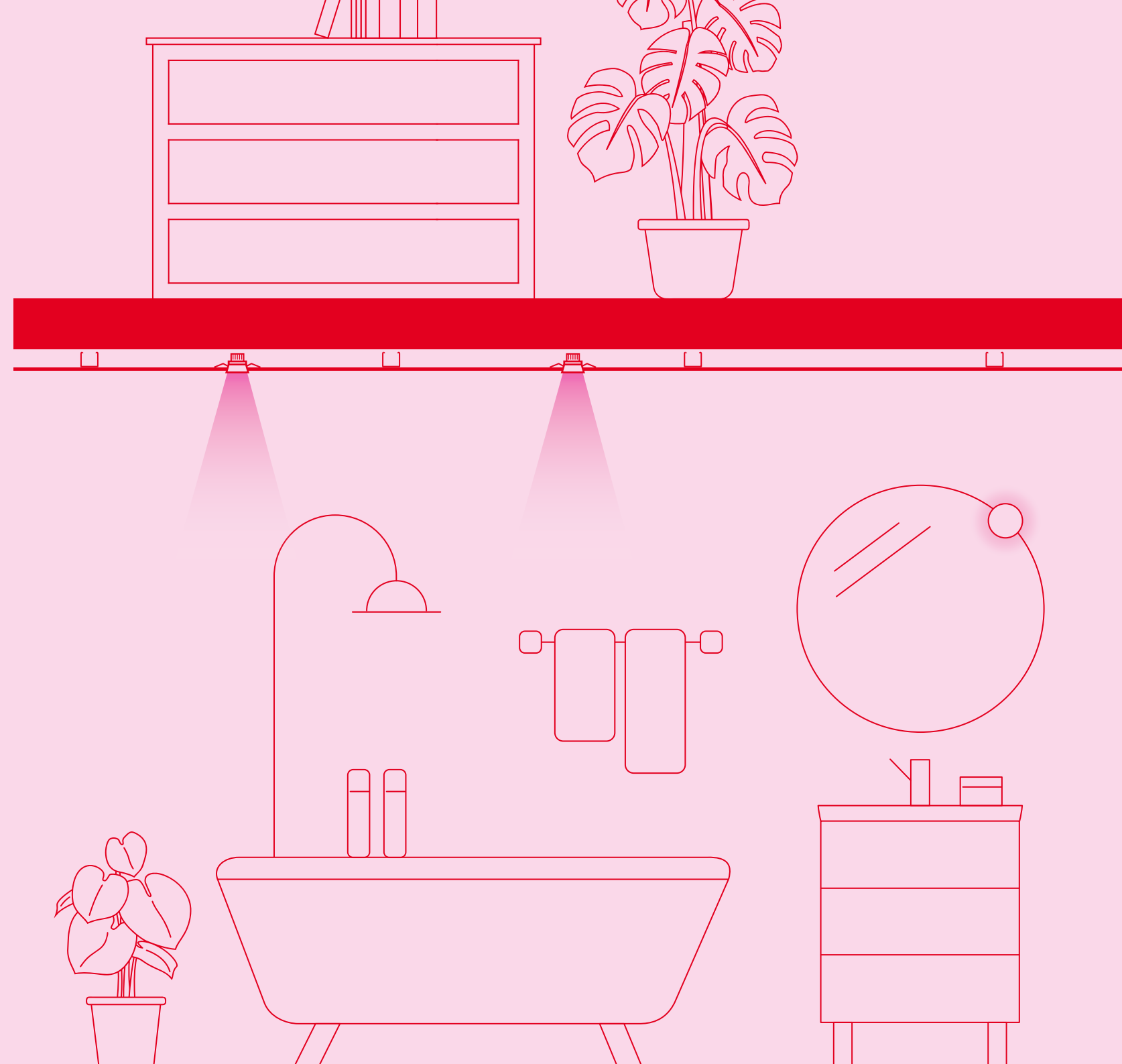



# DEEP point IP44

Ceiling recessed

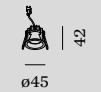

## 1.0

LED COB 4W | 250mA | 18V  
aluminium

IP44 32° SDCM2 L80|50K 0.06kg

wire springs 40-41 68 4-25

	CODE
White	185161W_
Black	185161B_

LIGHT COLOUR	LUMEN CRI	CODE
2700K	370 >90	3
3000K	410 >90	5

## ALWAYS USE

driver | 250mA

	CODE
5W dim   IP20	90226201
13W DALI   IP20*	90246501

\*revision opening required  
more options and specs on page 806



HOTEL MARTIN'S RENTMEESTERIJ | PCP ARCHITECTS BILZEN | BELGIUM

# DEEP bijou IP65

Ceiling recessed



## 1.0

LED COB 4W | 500mA | 8V  
aluminium

IP65 30° SDCM2 L80155K 0.09kg

wire springs 50-52 1.85 4-25

	CODE
	165361W_
	165361Q_
	165361B_

LIGHT COLOUR	LUMEN   CRI	CODE
2700K	470   >90	3
3000K	495   >90	5

## ALWAYS USE

driver | 500mA

	CODE
6W   IP20	90214201
6.5W dim   IP20*	90224301
7W   IP67	90214301

\*revision opening required  
more drivers on page 808



BLADE SPRING VERSIONS ONLINE  
weverducre.com/more-deep-bijou-ip65

Rev. 001/2024-05

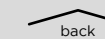
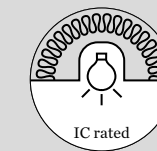



# DEEP petit IP65

Ceiling recessed

new

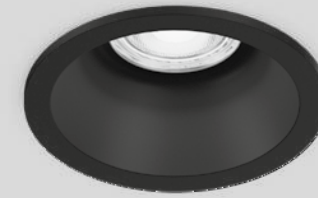

## 1.0

LED COB 6W | 350mA | 17V  
aluminium

IP65 31° SDCM2 L80|50K 0.10kg

wire springs ⌀68-70 60 4-25

CODE

153761W\_

153761B\_

LIGHT COLOUR LUMEN|CRI CODE

2700K 590|>90 3

3000K 610|>90 5

## ALWAYS USE

driver | 350mA

CODE

6W | IP20 90213303

10W dim | IP20 90223406

17W | IP68\* 90213602

\*revision opening required

more options and specs on page 806

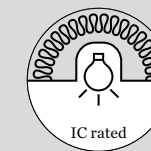
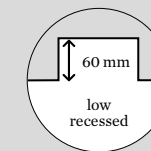

Rev. 001/2024-05

back



# DEEP IP65 | IP44

Ceiling recessed



## 1.0 LED

LED COB 6/9W | 350/500mA | 17V aluminium

IP65 33° SDCM2 L80I55K 0.24kg

wire springs 86-89 11.80 4-27

	CODE
White	184161W
Black	184161B

LIGHT COLOUR	LUMEN	CRI	CODE
2700K	485/640	>90	3
3000K	510/690	>90	5

## ALWAYS USE

driver | 500mA

	CODE
10W   IP20	90214406
10W dim   IP20	90224403
24W   IP68	90214702

more options and specs on page 808



## 1.0 MR16

QR-CBC51 max. 12W | GU5.3 | 12V aluminium

IP44 0.15kg

wire springs 86-89 11.90 4-25

	CODE
White	112610W0
Black	112610B0

LIGHT COLOUR	LUMEN	CRI	CODE
2700K	460lm	>90	3
3000K	457lm	>90	5

## ALWAYS USE

driver | 12V

	CODE
10W dim   IP20	90221401
25W dim   IP20	90221701

specs on page 810



## 1.0 PAR16

PAR16 max. 12W | GU10 100-240VAC | 50-60Hz aluminium

IP44 0.16kg

wire springs 86-89 11.25 4-25

	CODE
White	112620W0
Black	112620B0

LIGHT COLOUR	LUMEN	CRI	CODE
2700K	460lm	>90	3
3000K	457lm	>90	5

## OPTIONAL

PAR16 6.5W | GU10 | phase-cut dim

	CODE
2700K   460lm	901228W3
2700K   437lm	901228B3
3000K   500lm	901228W5
3000K   457lm	901228B5

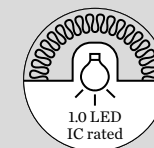

BLADE SPRING VERSION ONLINE

[weverducre.com/more-deep-ip44-65](http://weverducre.com/more-deep-ip44-65)

Rev. 001/2024-05

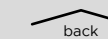

back





# DEEPER IP44

Ceiling recessed



## 1.0 LED

LED COB 6/9W | 350/500mA | 17V aluminium

IP44 34° SDCM2 L80I55K 0.17kg

wire springs 76-79 90 4-38

CODE	
152461W_	152461B_

LIGHT COLOUR	LUMEN	CRI	CODE
2700K	440/600	>90	3
3000K	480/645	>90	5
2000-3000K	320/470	>90	9

LED module 20 years replaceability

## ALWAYS USE

driver | 500mA

CODE	
10W   IP20	90214406
10W dim   IP20	90224403
24W DALI   IP20	90244701

more options and specs on page 808



## 1.0 MR16

QR-CBC51 max. 12W | GU5.3 | 12V aluminium

IP44 0.11kg

wire springs 76-79 100 4-38

CODE	
152210W0	152210B0

LIGHT COLOUR	LUMEN	CRI	CODE
2700K	440/600	>90	3
3000K	480/645	>90	5
2000-3000K	320/470	>90	9

LED module 20 years replaceability

## ALWAYS USE

driver | 12V

CODE	
10W dim   IP20	90221401
25W dim   IP20	90221701

specs on page 810



## 1.0 PAR16

PAR16 max. 12W | GU10 100-240VAC | 50-60Hz aluminium

IP44 0.15kg

wire springs 76-79 130 4-38

CODE	
152220W0	152220B0

LIGHT COLOUR	LUMEN	CRI	CODE
2700K	440/600	>90	3
3000K	480/645	>90	5
2000-3000K	320/470	>90	9

LED module 20 years replaceability

## OPTIONAL

PAR16 6.5W | GU10 | phase-cut dim

CODE	
2700K   460lm	901228W3
2700K   437lm	901228B3
3000K   500lm	901228W5
3000K   457lm	901228B5



RESTAURANT OSAR | STEENHUYSE INTERIEURARCHITECTEN TIELT | BELGIUM



# MATCH point IP44

Ceiling recessed



reddot winner 2023



As awarded by The Chicago Athenaeum: Museum of Architecture and Design

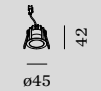

## 1.0

LED COB 5W | 250mA | 18V  
aluminium

IP44 | 32° SDCM2 L80|50K 0.06kg

wire springs | 40-41 | 68 | 4-25

	CODE
	191261W_
	191261B_

LIGHT COLOUR	LUMEN   CRI	CODE
2700K	300   >90	3
3000K	330   >90	5

## ALWAYS USE

driver | 250mA

	CODE
5W dim   IP20	90226201
13W DALI   IP20*	90246501

\*revision opening required  
more options and specs on page 806

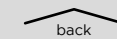

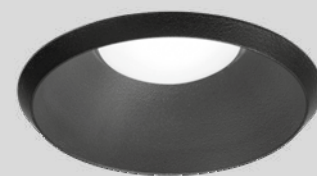

# TAIO IP65

Ceiling recessed



## 1.0

LED COB 6/9W | 350/500mA | 18V  
aluminium | opal glass convex lens

IP65 | 105° SDCM2 L80|55K 0.13kg

wire springs | 70 | L80 | 4-27

	CODE
	180781W_
	180781G_
	180781B_

LIGHT COLOUR	LUMEN	CRI	CODE
2700K	340/455	>90	3
3000K	370/495	>90	5

## ALWAYS USE

driver | 500mA

	CODE
10W   IP20	90214406
10W dim   IP20	90224403
24W   IP68	90214702

more options and specs on page 808

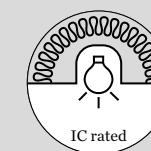

[back](#)



# RINI SNEAK IP44

Ceiling recessed



## 1.0 LED

LED COB 6/9W | 350/500mA | 17V aluminium

IP44 34° SDCM2 L80I55K 0.18kg

wire springs 76-79 52 4-25



## 1.0 MR16

QR-CBC51 max. 12W | GU5.3 | 12V aluminium

IP44 0.12kg

wire springs 76-79 55 4-25

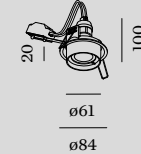

## 1.0 PAR16

PAR16 max. 12W | GU10 100-240VAC | 50-60Hz aluminium

IP44 0.16kg

wire springs 76-79 85 4-25

CODE
154461W_
154461B_

LIGHT COLOUR	LUMEN   CRI	CODE
2700K	465/625   >90	3
3000K	505/675   >90	5
2000-3000K	335/495   >90	9

LED module 20 years replaceability

## ALWAYS USE

driver | 500mA

	CODE
10W   IP20	90214406
10W dim   IP20	90224403
24W DALI   IP20	90244701

more options and specs on page 808

## ALWAYS USE

driver | 12V

	CODE
10W dim   IP20	90221401
25W dim   IP20	90221701

specs on page 810

## OPTIONAL

PAR16 6.5W | GU10 | phase-cut dim

	CODE
2700K   460lm	901228W3
2700K   437lm	901228B3
3000K   500lm	901228W5
3000K   457lm	901228B5

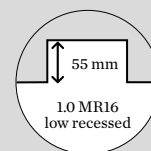
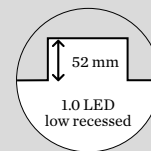



# LUNA IP44

Ceiling recessed

new

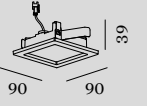
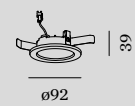
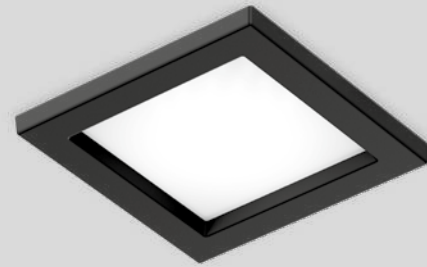

## 1.0 ROUND

LED PCB 6W | 350mA | 18V  
aluminium | opal PMMA cover

IP44 SDCM3 L80/100K 0.10kg

blade springs 76-79 55 min.12

3000K | CRI >90 | 505lm

	CODE
	114881W5
	114881B5

## ALWAYS USE

driver | 350mA

	CODE
6W   IP20	90213303
10W dim   IP20	90223406
14W DALI   IP20	90243501

more options and specs on page 806



## 1.0 SQUARE

LED PCB 6W | 350mA | 18V  
aluminium | opal PMMA cover

IP44 SDCM3 L80/100K 0.12kg

blade springs 73x73 52 min.12

3000K | CRI >90 | 540lm

	CODE
	114981W5
	114981B5

## ALWAYS USE

driver | 350mA

	CODE
6W   IP20	90213303
10W dim   IP20	90223406
14W DALI   IP20	90243501

more options and specs on page 806

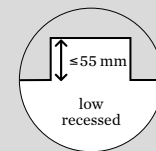



# PLANO IP44

Ceiling recessed

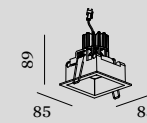

## 1.0 LED

LED COB 6/9W | 350/500mA | 17V aluminium

IP44 34° SDCM2 L80I55K 0.21kg

wire springs 76x78 90 4-30

CODE
118861W_
118861B_

LIGHT COLOUR	LUMEN   CRI	CODE
2700K	510/695   >90	3
3000K	550/740   >90	5
2000-3000K	365/535   >90	9

LED module 20 years replaceability

## ALWAYS USE

driver | 500mA

	CODE
10W   IP20	90214406
10W dim   IP20	90224403
24W DALI   IP20	90244701

more options and specs on page 808

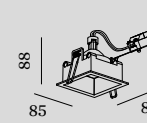

## 1.0 MR16

QR-CBC51 max. 35W | GU5.3 | 12V aluminium

IP44 0.15kg

wire springs 74x78 115 4-30

CODE
118410W0
118410B0

LIGHT COLOUR	LUMEN   CRI	CODE
2700K	460lm	901228W3
2700K	437lm	901228B3
3000K	500lm	901228W5
3000K	457lm	901228B5

LED module 20 years replaceability

## ALWAYS USE

driver | 12V

	CODE
10W dim   IP20	90221401
25W dim   IP20	90221701

specs on page 810

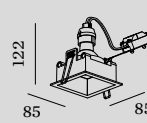

## 1.0 PAR16

PAR16 max. 12W | GU10 100-240VAC | 50-60Hz aluminium

IP44 0.19kg

wire springs 74x78 130 4-30

CODE
118420W0
118420B0

LIGHT COLOUR	LUMEN   CRI	CODE
2700K	460lm	901228W3
2700K	437lm	901228B3
3000K	500lm	901228W5
3000K	457lm	901228B5

LED module 20 years replaceability

## OPTIONAL

PAR16 6.5W | GU10 | phase-cut dim

	CODE
2700K   460lm	901228W3
2700K   437lm	901228B3
3000K   500lm	901228W5
3000K   457lm	901228B5



MORE BEAM ANGLES ONLINE

weverducre.com/more-plano-ip44



# PERLEZ IP44

Ceiling recessed

new

255 | 259 | 279

635

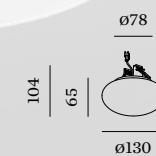

## 1.0

LED COB 6/9W | 350/500mA | 18V  
aluminium | opal glass

IP44 SDCM3 L80/50K 0.36kg

wire springs 46-51 68 4-25

CODE
192181W_

LIGHT COLOUR	LUMEN	CRI	CODE
2700K	510/720	>95	3
3000K	540/760	>95	5

### ALWAYS USE

driver | 350mA

CODE
90213303
90223301

driver | 500mA

CODE
90214406

more options and specs on page 806

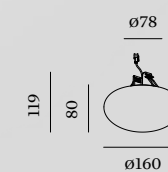

## 2.0

LED COB 6/9W | 350/500mA | 18V  
aluminium | opal glass

IP44 SDCM3 L80/50K 0.46kg

wire springs 46-51 68 4-25

CODE
192281W_

LIGHT COLOUR	LUMEN	CRI	CODE
2700K	560/770	>95	3
3000K	590/810	>95	5

### ALWAYS USE

driver | 350mA

CODE
90213303
90223301

driver | 500mA

CODE
90214406

more options and specs on page 806

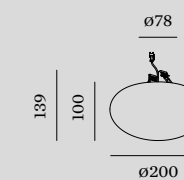

## 3.0

LED COB 6/9W | 350/500mA | 18V  
aluminium | opal glass

IP44 SDCM3 L80/50K 0.64kg

wire springs 46-51 68 4-25

CODE
192381W_

LIGHT COLOUR	LUMEN	CRI	CODE
2700K	610/820	>95	3
3000K	650/870	>95	5

### ALWAYS USE

driver | 350mA

CODE
90213303
90223301

driver | 500mA

CODE
90214406

more options and specs on page 806

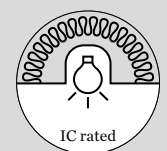

Rev. 001/2024-07

back

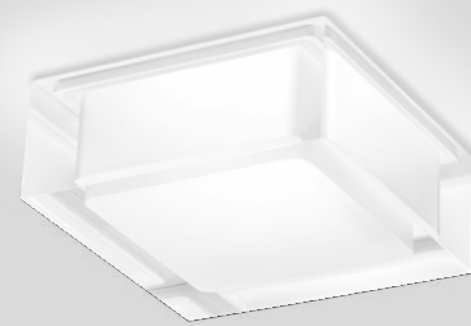

# MIRBI IP44

Ceiling recessed



283



643

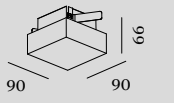
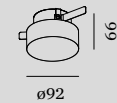

## 1.0

LED PCB 8W | phase-cut dim  
220-240VAC | 50-60Hz  
clear + opal PMMA cover

IP44 SDCM3 L80I60K 0.24kg

blade springs 76-79 50 min. 8

3000K | CRI >90 | 660lm

CODE

175688W5

## 2.0

LED PCB 8W | phase-cut dim  
220-240VAC | 50-60Hz  
clear + opal PMMA cover

IP44 SDCM3 L80I60K 0.26kg

blade springs 72x72 50 min. 8

3000K | CRI >90 | 660lm

CODE

175788W5

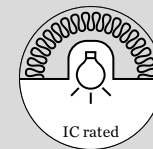
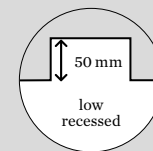





# CITY IP44

Ceiling recessed

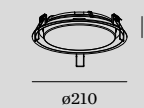

## 1.6

LED PCB 13W | phase-cut dim  
220-240VAC | 50-60Hz  
aluminium | opal PMMA cover

⊕ ↑ IP44 SDCM3 L80I60K 0.64kg

wire springs Ⓢ 202-205 Ⓢ 50 Ⓢ 4-22

3000K | CRI >90 | 1170lm

	CODE
	115488W5
	115488B5

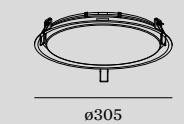

## 2.6

LED PCB 19W | phase-cut dim  
220-240VAC | 50-60Hz  
aluminium | opal PMMA cover

⊕ ↑ IP44 SDCM3 L80I60K 1.05kg

wire springs Ⓢ 297-300 Ⓢ 50 Ⓢ 4-22

3000K | CRI >90 | 1740lm

	CODE
	115588W5
	115588B5

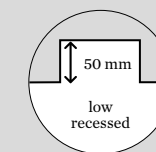

## DOWN LIGHTS



*new*  
**BOX MINI LED**  
165



**BOX MINI PAR16**  
167



**BOX**  
169



**DOCUS MINI**  
173



**DOCUS**  
175



**HEXO MINI**  
179



**HEXO**  
181



*new*  
**RAY MINI LED**  
185



**RAY MINI PAR16**  
187



**RAY**  
189



**SOLID BIJOU**  
193



**SOLID PETIT**  
195



**SOLID**  
197



**TRACE**  
201



**PIRRO PETIT**  
203



**PIRRO SPOT**  
205



**PIRRO OPAL**  
211



**PLANO PETIT**  
213



**PLANO**  
215



**SIRRO**  
217



*new*  
**LECA**  
221



**MATCH**  
223



*new*  
**MATCH 4.0**  
225



*new*  
**CENO**  
227



**BLIEK PETIT**  
235

## SPOT LIGHTS



**MICK**  
237



**SARA ON BASE**  
241



**SQUBE ON BASE**  
243

## LUMINAIRES



*new*  
**FIL SPIN**  
251



*new*  
**TRACE SPIN**  
253



*new*  
**PERLEZ SPIN**  
255



*new*  
**TRACE GRID**  
257



*new*  
**PERLEZ GRID**  
259

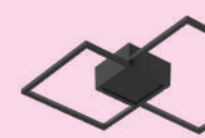

**VENN**  
261



**DRO**  
263



**WIRO**  
265



**MIRRO**  
267



**MIRRO SOFT**  
269



**CLEA**  
271



**J.J.W.**  
273



**ROOMOR OFFICE**  
275



**FINLIN**  
277

## IP-RATED



*new*  
**PERLEZ IP44**  
279



**TAIO IP65**  
281



**MIRBI IP44 1.0**  
283



**MIRBI IP44 2.0**  
283



**ROB IP44**  
285



**ROBY IP44**  
287



**TOWNA IP44**  
289

## MIX AND MATCH

# The magic cube

Remember that small magic cube we just couldn't put down in the 80s? Then you will love BOX. It has an almost infinite number of variations for you to try – not just in terms of colour and size. BOX is incredibly flexible when it comes to insets and lamps. Grab a double espresso and start mixing and matching. Not really into cubes? Then try taking a fantastic HEXO, DOCUS, or RAY luminaire home with you.

Können Sie sich noch an den magischen kleinen Würfel erinnern, den wir in den 80ern einfach nicht aus der Hand legen konnten? Dann werden Sie BOX lieben. Denn auch mit ihr lassen sich nahezu unendlich viele Varianten durchprobieren. Und das nicht nur in puncto Farben und Größe. Auch bei Insets und Leuchtmitteln ist BOX mehr als nur flexibel. Also einfach einen doppelten Espresso schnappen und loskombinieren. Würfel sind nicht so Ihr Ding? Dann können Sie sich mit HEXO, DOCUS oder RAY auch andere tolle Leuchtenformen dieser Serie nach Hause holen.



[weverducre.com/universalstars](https://weverducre.com/universalstars)

### SHADE COLOUR

- W White matt powder coated
- L Aluminium wet painted brushed
- G Gold wet painted brushed
- M Champagne wet painted brushed
- Q Bronze wet painted brushed
- P Copper wet painted brushed
- B Black matt powder coated

### INNER REFLECTOR COLOUR

- W White matt wet painted
- G Gold wet painted
- M Champagne wet painted
- Q Bronze wet painted
- B Black matt wet painted

### INNER COVER COLOUR

- W White matt wet painted
- G Gold wet painted
- M Champagne wet painted
- B Black matt wet painted



BOX MINI  
CHAMPAGNE INNER REFLECTOR



BOX MINI  
WHITE INNER REFLECTOR



BOX MINI  
WHITE INNER REFLECTOR



BOX  
WITHOUT INSET



BOX  
GOLD INNER COVER



BOX  
BLACK INNER COVER

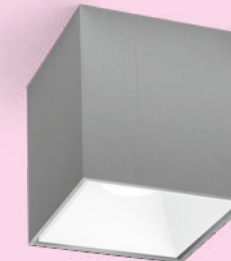

BOX  
WHITE INNER REFLECTOR



BOX 2.0  
GOLD INNER REFLECTOR



BOX  
BLACK INNER REFLECTOR



PRIVATE RESIDENCE | JACO GOUDRIAAN THE NETHERLANDS

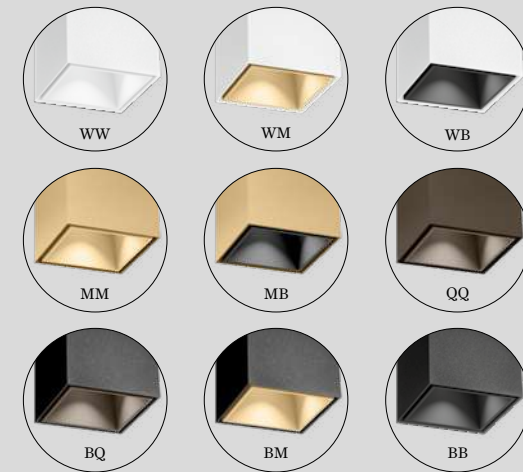

# BOX mini

Ceiling surface

new

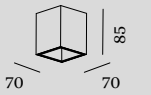

## 1.0 LED

LED LED COB 10W | phase-cut dim  
220-240VAC | 50-60Hz  
incl. driver | aluminium

IP20  $\Delta$  25° SDCM2 L80|55K 0.24kg

	CODE
	258154WW_
	258154WM_
	258154WB_
	258154MM_
	258154MB_
	258154QQ_
	258154BQ_
	258154BM_
	258154BB_

LIGHT COLOUR	LUMEN CRI	CODE
2700K	440 >90	3
3000K	470 >90	5

Rev.001/2024-05

back



# BOX mini

Ceiling surface

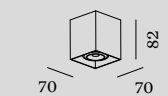

## 1.0 PAR16

PAR16 max. 12W | GU10  
100-240VAC | 50-60Hz  
aluminium

IP20 0.16kg

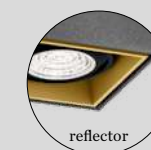

reflector

### OPTIONAL

inner reflector max. 10W  
polycarbonate

	CODE
	900199W1
	900199G1
	900199M1
	900199Q1
	900199B1

	CODE
	258120W0
	258120G0
	258120M0
	258120Q0
	258120B0

### OPTIONAL

PAR16 6.5W | GU10 | phase-cut dim

	CODE
	901228W3
	901228B3
	901228W5
	901228B5

back



# BOX

Ceiling surface

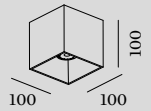
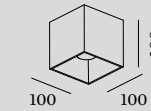
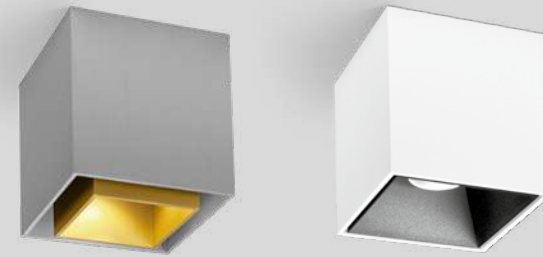

## 1.0 LED

LED COB 8W | dimmable  
220-240VAC | 50-60Hz  
aluminium

IP20 21° SDCM3 L70|50K 0.74kg

## 1.0 PAR16

PAR16 max. 12W | GU10  
100-240VAC | 50-60Hz  
aluminium

IP20 0.66kg

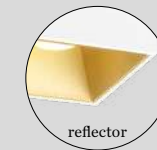

reflector

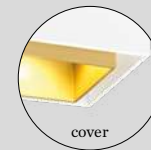

cover

### OPTIONAL

inner reflector max. 10W  
polycarbonate

CODE	REFLECTOR
911211W1	White
911211G1	Gold
911211M1	Matte Gold
911211B1	Black

inner cover max. 10W  
aluminium

CODE	COLOR
911011W1	White
911011G1	Gold
911011M1	Matte Gold
911011B1	Black

### phase-cut dim

CODE	REFLECTOR
186158W_	White
186158L_	Light Grey
186158G_	Gold
186158M_	Matte Gold
186158Q_	Dark Grey
186158P_	Orange
186158B_	Black

### DALI

CODE	REFLECTOR
186159W_	White
186159L_	Light Grey
186159G_	Gold
186159M_	Matte Gold
186159Q_	Dark Grey
186159P_	Orange
186159B_	Black

CODE	LIGHT COLOUR	LUMEN CRI	CODE
911011W1	2700K	670 >90	3
911011G1	3000K	700 >90	5
911011M1	2000-3000K*	470 >90	9

\*only for phase-cut dim

CODE	REFLECTOR
146120W0	White
146120L0	Light Grey
146120G0	Gold
146120M0	Matte Gold
146120Q0	Dark Grey
146120P0	Orange
146120B0	Black

### OPTIONAL

PAR16 6.5W | GU10 | phase-cut dim

CODE	LIGHT COLOUR	LUMEN	CODE
901228W3	2700K   460lm		901228W3
901228B3	2700K   437lm		901228B3
901228W5	3000K   500lm		901228W5
901228B5	3000K   457lm		901228B5



PRIVATE RESIDENCE | DECOFORM BELGIUM

# BOX

Ceiling surface

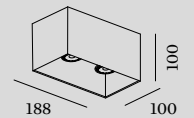
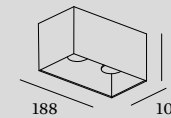
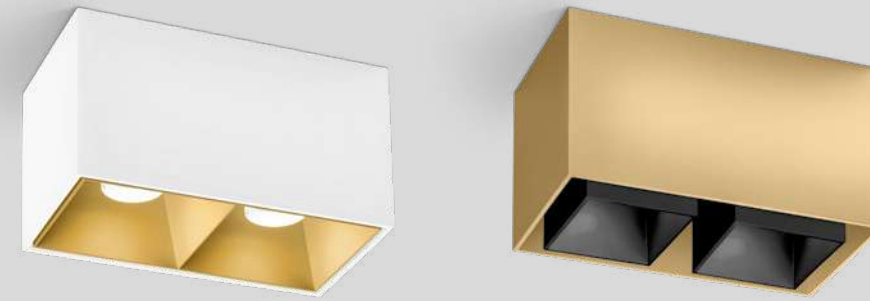

## 2.0 LED

LED COB 16W | phase-cut dim  
220-240VAC | 50-60Hz  
aluminium

IP20  $\Delta$  21° SDCM3 L70|50K 1.08kg

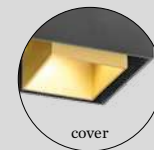
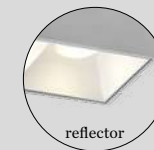

### OPTIONAL

double inner reflector max. 10W  
polycarbonate

Color	CODE
White	911251W1
Gold	911251G1
Dark Gold	911251M1
Black	911251B1

inner cover max. 10W  
aluminium | 2 pieces needed

Color	CODE
White	911011W1
Gold	911011G1
Dark Gold	911011M1
Black	911011B1

LIGHT COLOUR	LUMEN   CRI	CODE
2700K	2x670   >90	3
3000K	2x700   >90	5
2000-3000K	2x470   >90	9

## 2.0 PAR16

2x PAR16 max. 12W | GU10  
100-240VAC | 50-60Hz  
aluminium

IP20 1.13kg

Color	CODE
White	146220W0
Gold	146220L0
Dark Gold	146220G0
Black	146220M0
Black	146220Q0
Black	146220P0
Black	146220B0

### OPTIONAL

PAR16 6.5W | GU10 | phase-cut dim

Color	CODE
2700K   460lm	901228W3
2700K   437lm	901228B3
3000K   500lm	901228W5
3000K   457lm	901228B5

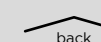



OFFICE INARTO | INARTO ARCHITECTEN HERENTALS | BELGIUM

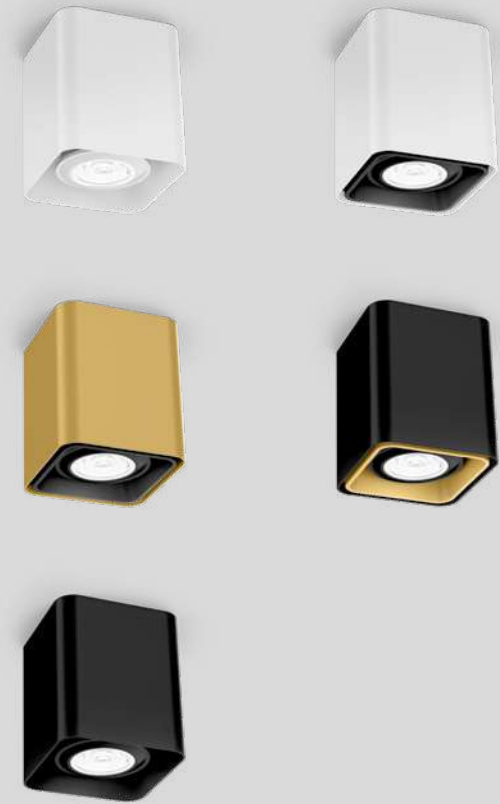

# DOCUS mini

Ceiling surface

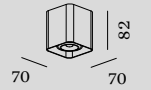

## 1.0

PAR16 max. 12W | GU10  
100-240VAC | 50-60Hz  
aluminium

IP20 0.16kg



### OPTIONAL

inner reflector max. 10W  
polycarbonate

CODE	Color
900199W2	White
900199G2	Gold
900199B2	Black

### OPTIONAL

PAR16 6.5W | GU10 | phase-cut dim

CODE	Color	Color	Color
2700K   460lm	258320W0	901228W3	White
2700K   437lm	258320G0	901228B3	Black
3000K   500lm	258320B0	901228W5	White
3000K   457lm		901228B5	Black





# DOCUS

Ceiling surface

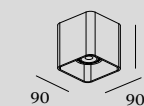
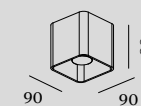

## 1.0 LED

LED COB 8W | dimmable  
220-240VAC | 50-60Hz  
aluminium

IP20  $\Delta$  21° SDCM3 L70|50K 0.63kg

phase-cut dim

	CODE
	186358W_
	186358L_
	186358G_
	186358P_
	186358B_

DALI

	CODE
	186359W_
	186359L_
	186359G_
	186359P_
	186359B_



## OPTIONAL

inner cover max. 10W  
aluminium

CODE	LIGHT COLOUR	LUMEN CRI	CODE
911021W1	2700K	670 >90	3
911021G1	3000K	700 >90	5
911021B1	2000-3000K*	470 >90	9

\*only for phase-cut dim

## 1.0 PAR16

PAR16 max. 12W | GU10  
100-240VAC | 50-60Hz  
aluminium

IP20 0.55kg

	CODE
	146320W0
	146320L0
	146320G0
	146320P0
	146320B0

## OPTIONAL

PAR16 6.5W | GU10 | phase-cut dim

	CODE
2700K   460lm	901228W3
2700K   437lm	901228B3
3000K   500lm	901228W5
3000K   457lm	901228B5

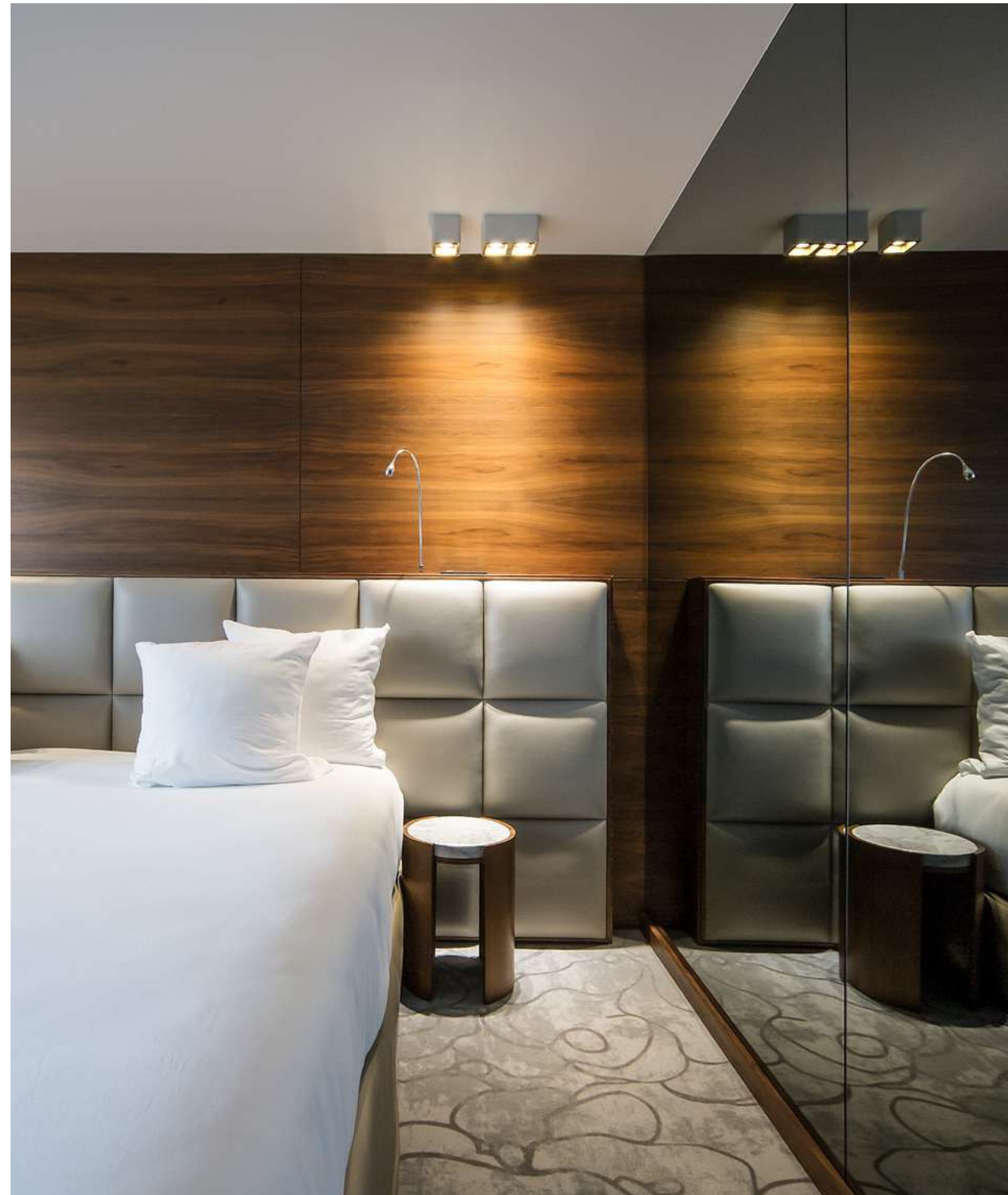

# DOCUS

Ceiling surface

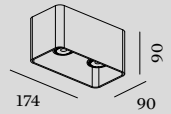
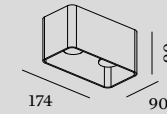
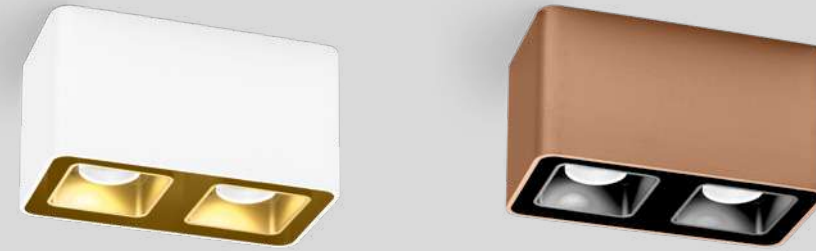

## 2.0 LED

LED COB 16W | phase-cut dim  
220-240VAC | 50-60Hz  
aluminium

IP20 21° SDCM3 L70|50K 0.92kg

## 2.0 PAR16

2x PAR16 max. 12W | GU10  
100-240VAC | 50-60Hz  
aluminium

IP20 1.01kg



## OPTIONAL

inner cover max. 10W  
aluminium | 2 pieces needed

	CODE
	911021W1
	911021G1
	911021B1

	CODE
	186458W_
	186458L_
	186458G_
	186458P_
	186458B_

LIGHT COLOUR	LUMEN CRI	CODE
2700K	2x670   >90	3
3000K	2x700   >90	5
2000-3000K	2x470   >90	9

	CODE
	146420W0
	146420L0
	146420G0
	146420P0
	146420B0

## OPTIONAL

PAR16 6.5W | GU10 | phase-cut dim

	CODE	
	2700K   460lm	901228W3
	2700K   437lm	901228B3
	3000K   500lm	901228W5
	3000K   457lm	901228B5



PRIVATE RESIDENCE | TOM BEIGE / \*NESS HUNGARY



# HEXO mini

Ceiling surface



## 1.0

PAR16 max. 12W | GU10  
100-240VAC | 50-60Hz  
aluminium

IP20 0.15kg



### OPTIONAL

inner reflector max. 10W  
polycarbonate

CODE	
900199W3	White
900199G3	Yellow
900199Q3	Brown
900199B3	Dark Grey

CODE	
258420W0	White
258420G0	Yellow
258420Q0	Brown
258420B0	Dark Grey

### OPTIONAL

PAR16 6.5W | GU10 | phase-cut dim

CODE		CODE	
2700K   460lm	901228W3	3000K   457lm	901228B5
2700K   437lm	901228B3		
3000K   500lm	901228W5		

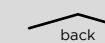



# HEXO

Ceiling surface

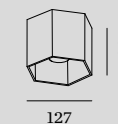
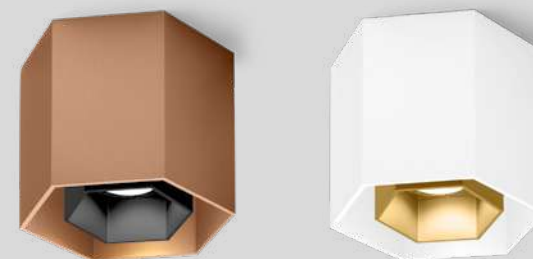

## 1.0 LED

LED COB 8W | dimmable  
220-240VAC | 50-60Hz  
aluminium

IP20 21° SDCM3 L70|50K 0.72kg

phase-cut dim

	CODE
	186558W_
	186558G_
	186558Q_
	186558P_
	186558B_

DALI

	CODE
	186559W_
	186559G_
	186559Q_
	186559P_
	186559B_

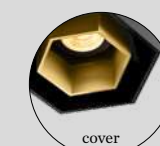

## OPTIONAL

inner cover max. 10W  
aluminium

CODE	LIGHT COLOUR	LUMEN CRI	CODE
911031W1	2700K	670 >90	3
911031G1	3000K	700 >90	5
911031B1	2000-3000K*	470 >90	9

LIGHT COLOUR	LUMEN CRI	CODE
2700K	460lm	901228W3
2700K	437lm	901228B3
3000K	500lm	901228W5
3000K	457lm	901228B5

\*only for phase-cut dim

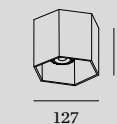

## 1.0 PAR16

PAR16 max. 12W | GU10  
100-240VAC | 50-60Hz  
aluminium

IP20 0.63kg

	CODE
	146520W0
	146520G0
	146520Q0
	146520P0
	146520B0

## OPTIONAL

PAR16 6.5W | GU10 | phase-cut dim

LIGHT COLOUR	LUMEN CRI	CODE
2700K	460lm	901228W3
2700K	437lm	901228B3
3000K	500lm	901228W5
3000K	457lm	901228B5



# HEXO

Ceiling surface

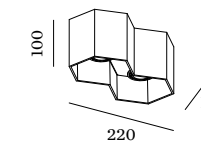
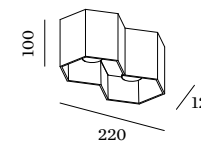

## 2.0 LED

LED COB 16W | phase-cut dim  
220-240VAC | 50-60Hz  
aluminium

IP20 21° SDCM3 L70|50K 1.13kg

## 2.0 PAR16

2x PAR16 max. 12W | GU10  
100-240VAC | 50-60Hz  
aluminium

IP20 1.19kg

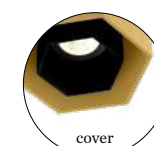

## OPTIONAL

inner cover max. 10W  
aluminium | 2 pieces needed

CODE
911031W1
911031G1
911031B1

CODE
186658W_
186658G_
186658Q_
186658P_
186658B_

LIGHT COLOUR	LUMEN CRI	CODE
2700K	2x670 >90	3
3000K	2x700 >90	5
2000-3000K	2x470 >90	9

CODE
146620W0
146620G0
146620Q0
146620P0
146620B0

## OPTIONAL

PAR16 6.5W | GU10 | phase-cut dim

CODE	
2700K   460lm	901228W3
2700K   437lm	901228B3
3000K   500lm	901228W5
3000K   457lm	901228B5



# RAY mini

Ceiling surface

new



543

## 1.0 LED

LED COB 10W | phase-cut dim  
220-240VAC | 50-60Hz  
incl. driver | aluminium

IP20 25° SDCM2 L80|55K 0.19kg

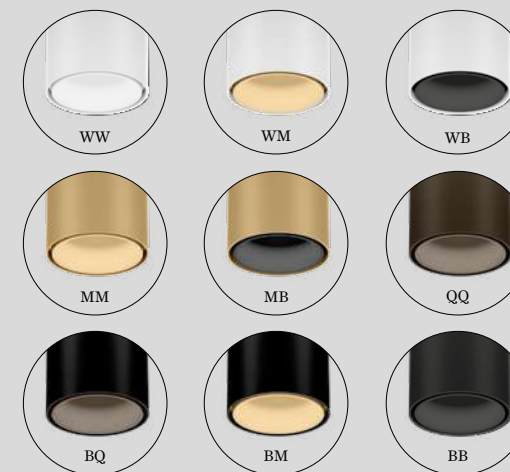

	CODE
	258254WW_
	258254WM_
	258254WB_
	258254MM_
	258254MB_
	258254QQ_
	258254BM_
	258254BB_

LIGHT COLOUR	LUMEN CRI	CODE
2700K	440 >90	3
3000K	470 >90	5



# RAY mini

Ceiling surface



## 1.0 PAR16

PAR16 max. 12W | GU10  
100-240VAC | 50-60Hz  
aluminium

IP20 0.14kg



### OPTIONAL

inner reflector max. 10W  
polycarbonate

	CODE
	900199W4
	900199G4
	900199M4
	900199Q4
	900199B4

	CODE
	258220W0
	258220G0
	258220M0
	258220Q0
	258220B0

### OPTIONAL

PAR16 6.5W | GU10 | phase-cut dim

	CODE
	901228W3
	901228B3
	901228W5
	901228B5



HOTEL MÜHLE | DI RAINER SCHÖPF OBERGURGL | AUSTRIA

# RAY

Ceiling surface

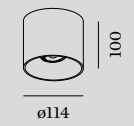
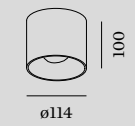

## 1.0 LED

LED COB 8W | dimmable  
220-240VAC | 50-60Hz  
aluminium

IP20 21° SDCM3 L70|50K 0.70kg

## 1.0 PAR16

PAR16 max. 12W | GU10  
100-240VAC | 50-60Hz  
aluminium

IP20 0.61kg

### phase-cut dim

	CODE
	186758W_
	186758L_
	186758G_
	186758M_
	186758Q_
	186758P_
	186758B_

	CODE
	146720W0
	146720L0
	146720G0
	146720M0
	146720Q0
	146720P0
	146720B0

### DALI

	CODE
	186759W_
	186759L_
	186759G_
	186759M_
	186759Q_
	186759P_
	186759B_

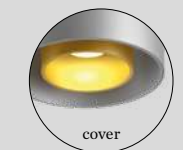

### OPTIONAL

inner cover max. 10W  
aluminium

	CODE	LIGHT COLOUR	LUMEN CRI	CODE
	911041W1	2700K	670 >90	3
	911041G1	3000K	700 >90	5
	911041M1	2000-3000K*	470 >90	9
	911041B1			

\*only for phase-cut dim

### OPTIONAL

PAR16 6.5W | GU10 | phase-cut dim

	CODE
	901228W3
	901228B3
	901228W5
	901228B5

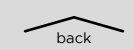







IVAN ELTOFT NIELSEN REAL ESTATE AGENT | JULIE BRANDT | ANKER & CO HELLERUP | DENMARK

# SOLID bijou

Ceiling surface



## 1.0

LED LED COB 6W | phase-cut dim  
220-240V | 50-60Hz | incl. driver  
aluminium

IP20 A 27° SDCM2 L80|50K 0.32kg

	CODE
	133864W_
	133864J_
	133864H_
	133864K_
	133864CH_
	133864B_

LIGHT COLOUR	LUMEN CRI	CODE
2700K	325 >90	3
3000K	340 >90	5



# SOLID petit

Ceiling surface



## 2.0

LED COB 9W | phase-cut dim  
220-240VAC | 50-60Hz | incl. driver  
aluminium

IP20 0°-25°|355° A 31° SDCM2 L80|50K 0.42kg

### CODE

	133964W_
	133964J_
	133964H_
	133964K_
	133964CH_
	133964B_

LIGHT COLOUR	LUMEN	CRI	CODE
2700K	540	>90	3
3000K	570	>90	5
2000-3000K	440	>90	9



**MORE BEAM ANGLES ONLINE**  
weverducre.com/more-solid-petit



### 1.0 LED

LED LED COB 12W | dimmable  
220-240VAC | 50-60Hz | incl. driver  
aluminium

IP20 0°-25°|355° 34° SDCM2 L80|55K 0.65kg

phase-cut dim

CODE	CODE
133764W_	133120W0
133764J_	133120J0
133764H_	133120H0
133764K_	133120K0
133764CH_	133120CH0
133764P_	133120P0
133764Q_	133120Q0
133764B_	133120B0

DALI-2 | push dim

CODE	CODE
133765W_	133120W0
133765J_	133120J0
133765H_	133120H0
133765K_	133120K0
133765CH_	133120CH0
133765P_	133120P0
133765Q_	133120Q0
133765B_	133120B0

LIGHT COLOUR	LUMEN   CRI	CODE
2700K	745   >90	3
3000K	800   >90	5
2000-3000K	560   >90	9

### 1.0 PAR16

PAR16 max. 12W | GU10  
100-240VAC | 50-60Hz  
aluminium

IP20 0°-25°|355° 0.61kg

CODE	CODE
133120W0	133120W0
133120J0	133120J0
133120H0	133120H0
133120K0	133120K0
133120CH0	133120CH0
133120P0	133120P0
133120Q0	133120Q0
133120B0	133120B0

### OPTIONAL

PAR16 6.5W   GU10   phase-cut dim	CODE
2700K   460lm	901228W3
2700K   437lm	901228B3
3000K   500lm	901228W5
3000K   457lm	901228B5



MORE BEAM ANGLES ONLINE

[weverducre.com/more-solid](https://weverducre.com/more-solid)

Rev. 001/2024-05

# SOLID

Ceiling surface







# TRACE

Ceiling surface



reddot winner 2023

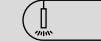

373 | 399



517



## 1.0

LED COB 6W | phase-cut dim  
220-240VAC | 50-60Hz | incl. driver  
aluminium

IP20 A 27° SDCM2 180|50K 0.40kg

	CODE
	183164W_
	183164BL_
	183164CH_
	183164B_

LIGHT COLOUR	LUMEN CRI	CODE
2700K	325 >90	3
3000K	340 >90	5

Rev. 001/2024-05

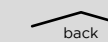



# PIRRO petit

Ceiling surface

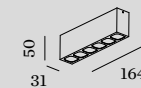
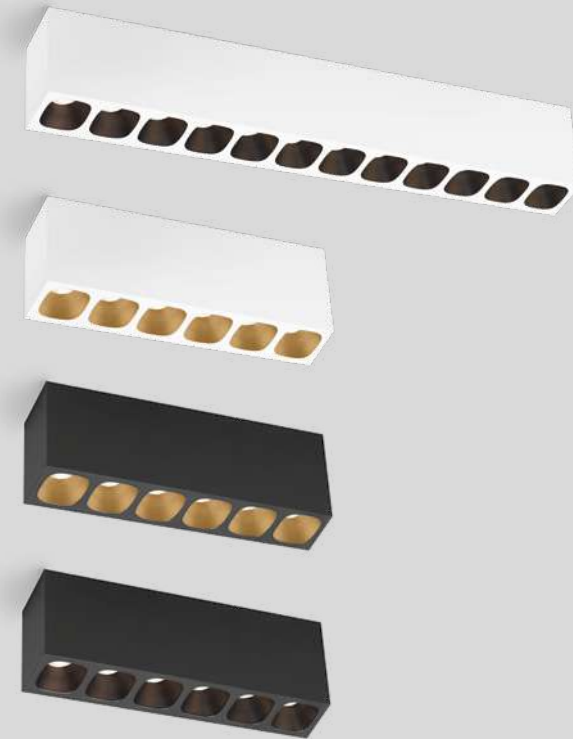

## 6.0

LED COB 13W | phase-cut dim  
220-240VAC | 50-60Hz | incl. driver  
aluminium

IP20  $\angle$  28° SDCM3 L80|50K 0.21kg

CODE	
	129854E_
	129854WM_
	129854CH_
	129854B_

LIGHT COLOUR	LUMEN CRI	CODE
2700K	6x135 >90	3
3000K	6x140 >90	5

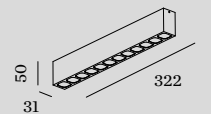

## 12.0

LED COB 26W | phase-cut dim  
220-240VAC | 50-60Hz | incl. driver  
aluminium

IP20  $\angle$  28° SDCM3 L80|50K 0.38kg

CODE	
	129954E_
	129954WM_
	129954CH_
	129954B_

LIGHT COLOUR	LUMEN CRI	CODE
2700K	12x135 >90	3
3000K	12x140 >90	5



# PIRRO SPOT

Ceiling surface



93



339 | 361

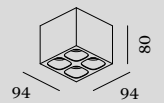
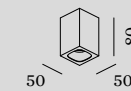

## 1.0

LED COB 6W | phase-cut dim  
220-240VAC | 50-60Hz | incl. driver  
aluminium

IP20 A-32° SDCM2 L70|55K 0.20kg

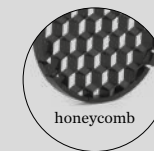

### OPTIONAL

honeycomb louver

CODE	LIGHT COLOUR	LUMEN CRI	CODE
90051131	2700K	360 >90	3
	3000K	380 >90	5

## 4.1

LED COB 20W | phase-cut dim  
220-240VAC | 50-60Hz | incl. driver  
aluminium

IP20 A-32° SDCM2 L70|55K 0.50kg

CODE	LIGHT COLOUR	LUMEN CRI	CODE
151564E_	2700K	4x360 >90	3
151564J_	3000K	4x380 >90	5

back





PRIVATE RESIDENCE | PADRON LUXURY LIVING BELGIUM

# PIRRO SPOT

Ceiling surface

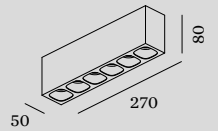
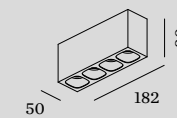
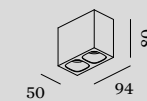
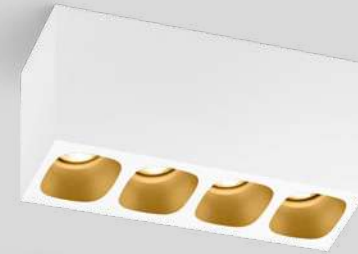
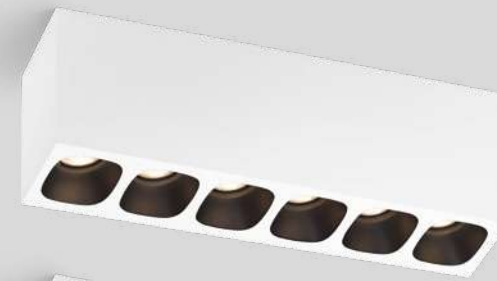

## 2.0

LED COB 11W | phase-cut dim  
220-240VAC | 50-60Hz | incl. driver  
aluminium

⊕ IP20  $\Lambda$  32° SDCM2 L70|55K 0.30kg

## 4.0

LED COB 20W | phase-cut dim  
220-240VAC | 50-60Hz | incl. driver  
aluminium

⊕ IP20  $\Lambda$  32° SDCM2 L70|55K 0.48kg

## 6.0

LED COB 29W | phase-cut dim  
220-240VAC | 50-60Hz | incl. driver  
aluminium

⊕ IP20  $\Lambda$  32° SDCM2 L70|55K 0.80kg

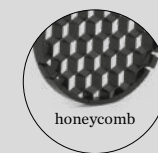

### OPTIONAL

honeycomb louver

90051131

CODE			
	151264E		151264J
	151264K		151264B

LIGHT COLOUR	LUMEN CRI	CODE
2700K	2x360 >90	3
3000K	2x380 >90	5

CODE			
	151464E		151464J
	151464K		151464B

LIGHT COLOUR	LUMEN CRI	CODE
2700K	4x360 >90	3
3000K	4x380 >90	5

CODE			
	151664E		151664J
	151664K		151664B

LIGHT COLOUR	LUMEN CRI	CODE
2700K	6x360 >90	3
3000K	6x380 >90	5

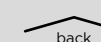

339 | 361

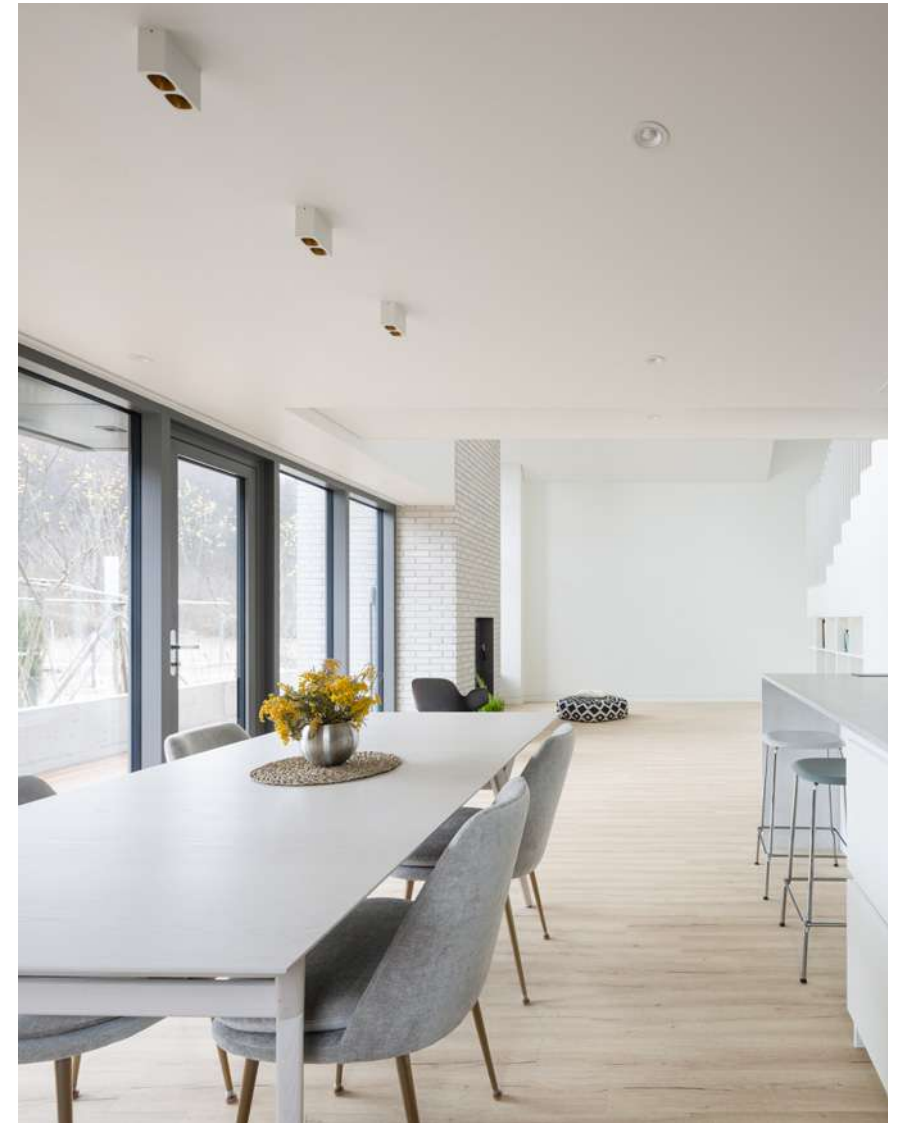



PRIVATE RESIDENCE | ORANEN & TURKLIN FINLAND

# PIRRO OPAL

Ceiling surface

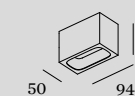
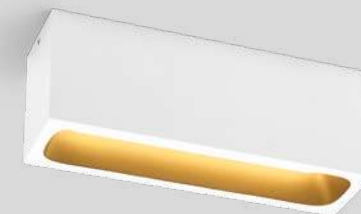
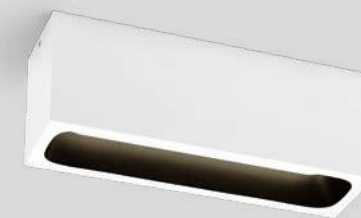

## 2.0

LED PCB 7W | phase-cut dim  
220-240VAC | 50-60Hz | incl. driver  
aluminium | opal PMMA cover

IP20 SDCM3 L80/60K 0.30kg

CODE	
	151284E_
	151284J_
	151284K_
	151284B_

LIGHT COLOUR	LUMEN CRI	CODE
2700K	270 >90	3
3000K	290 >90	5

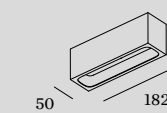

## 4.0

LED PCB 12W | phase-cut dim  
220-240VAC | 50-60Hz | incl. driver  
aluminium | opal PMMA cover

IP20 SDCM3 L80/60K 0.52kg

CODE	
	151484E_
	151484J_
	151484K_
	151484B_

LIGHT COLOUR	LUMEN CRI	CODE
2700K	710 >90	3
3000K	740 >90	5

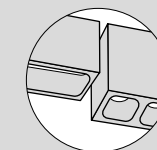

back



339 | 361



# PLANO petit

Ceiling surface

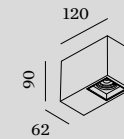

## 1.0

LED COB 8W | phase-cut dim  
220-240VAC | 50-60Hz | incl. driver  
aluminium

IP20 0°-25°/355° 31° SDCM2 L70|55K 0.48kg

CODE	
	162564W_
	162564E_
	162564CH_
	162564B_

LIGHT COLOUR	LUMEN	CRI	CODE
2700K	490	>90	3
3000K	530	>90	5
2000-3000K	380	>90	9

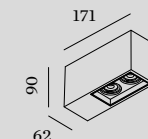

## 2.0

LED COB 15W | phase-cut dim  
220-240VAC | 50-60Hz | incl. driver  
aluminium

IP20 0°-25°/355° 31° SDCM2 L70|55K 0.62kg

CODE	
	162664W_
	162664E_
	162664CH_
	162664B_

LIGHT COLOUR	LUMEN	CRI	CODE
2700K	2x490	>90	3
3000K	2x530	>90	5
2000-3000K	2x380	>90	9

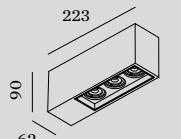

## 3.0

LED COB 22W | phase-cut dim  
220-240VAC | 50-60Hz | incl. driver  
aluminium

IP20 0°-25°/355° 31° SDCM2 L70|55K 0.85kg

CODE	
	162764W_
	162764E_
	162764CH_
	162764B_

LIGHT COLOUR	LUMEN	CRI	CODE
2700K	3x490	>90	3
3000K	3x530	>90	5
2000-3000K	3x380	>90	9



**MORE BEAM ANGLES ONLINE**  
weverducre.com/more-plano-surface

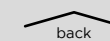



# PLANO

Ceiling surface

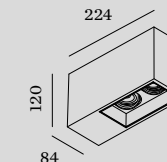
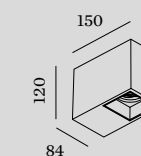
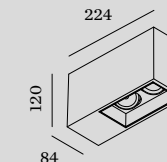
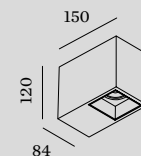
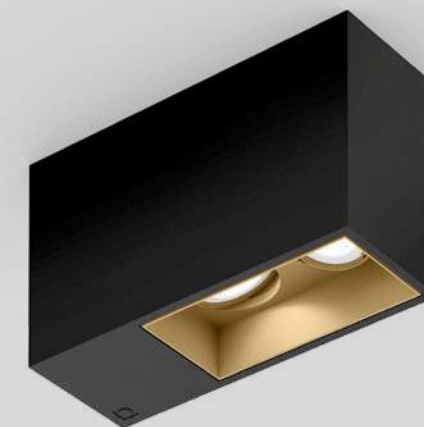
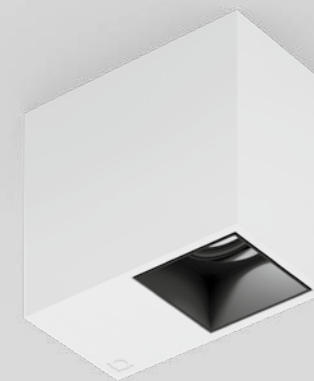

## 1.0 LED

LED COB 12W | phase-cut dim  
220-240VAC | 50-60Hz | incl. driver  
aluminium

IP20 0°-30°|355° A-34° SDCM2 L80|55K 1.15kg

## 2.0 LED

LED COB 22W | phase-cut dim  
220-240VAC | 50-60Hz | incl. driver  
aluminium

IP20 0°-30°|355° A-34° SDCM2 L80|55K 1.62kg

## 1.0 PAR16

PAR16 max. 12W | GU10  
100-240VAC | 50-60Hz  
aluminium

IP20 0°-30°|355° 1.39kg

## 2.0 PAR16

2x PAR16 max. 12W | GU10  
100-240VAC | 50-60Hz  
aluminium

IP20 0°-30°|355° 1.51kg

CODE
118564W_
118564E_
118564CH_
118564B_

LIGHT COLOUR	LUMEN CRI	CODE
2700K	570 >90	3
3000K	630 >90	5
2000-3000K	535 >90	9



MORE BEAM ANGLES ONLINE  
weverducre.com/more-plano-surface

CODE
118520W_
118520E_
118520CH_
118520B_

LIGHT COLOUR	LUMEN CRI	CODE
2700K	2x570 >90	3
3000K	2x630 >90	5
2000-3000K	2x535 >90	9

CODE
118520W0
118520E0
118520CH0
118520B0

## OPTIONAL

PAR16 6.5W | GU10 | phase-cut dim

CODE	
2700K   460lm	901228W3
2700K   437lm	901228B3
3000K   500lm	901228W5
3000K   457lm	901228B5

CODE
118620W_
118620E_
118620CH_
118620B_

## OPTIONAL

PAR16 6.5W | GU10 | phase-cut dim

CODE	
2700K   460lm	901228W3
2700K   437lm	901228B3
3000K   500lm	901228W5
3000K   457lm	901228B5



# SIRRO

Ceiling surface

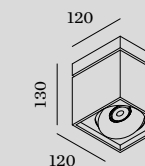
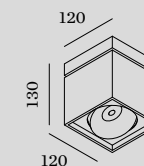

## 1.0 LED

LED COB 12W | phase-cut dim  
220-240VAC | 50-60Hz | incl. driver  
aluminium

IP20 0°-35°/355°  $\Delta$  34° SDCM2 L80/55K 0.85kg

	CODE
	189164W_
	189164E_
	189164B_

LIGHT COLOUR	LUMEN   CRI	CODE
2700K	715   >90	3
3000K	775   >90	5
2000-3000K	560   >90	9

## 1.0 PAR16

PAR16 max. 12W | GU10  
100-240VAC | 50-60Hz  
aluminium

IP20 0°-35°/355° 0.81kg

	CODE
	139120W0
	139120E0
	139120B0

## OPTIONAL

	CODE
2700K   460lm	901228W3
2700K   437lm	901228B3
3000K   500lm	901228W5
3000K   457lm	901228B5



# SIRRO

Ceiling surface

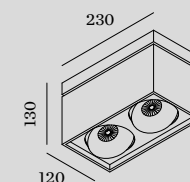
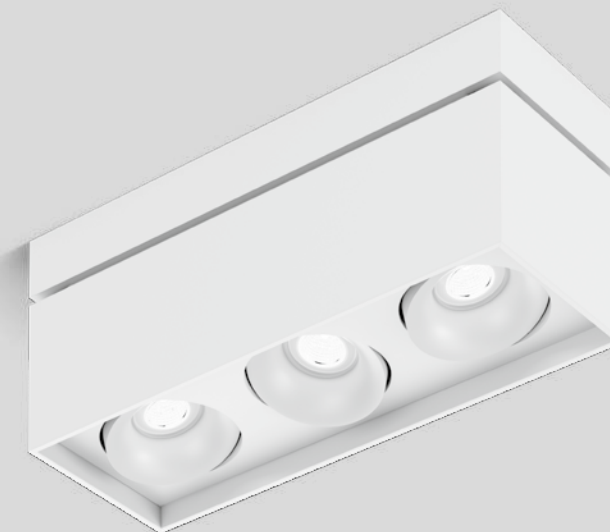

## 2.0 LED

LED LED COB 20W | phase-cut dim  
220-240VAC | 50-60Hz | incl. driver  
aluminium

IP20 0°-35°/355° A 34° SDCM2 L80|55K 1.57kg

CODE
189264W_
189264E_
189264B_

LIGHT COLOUR	LUMEN CRI	CODE
2700K	2x715 >90	3
3000K	2x775 >90	5
2000-3000K	2x560 >90	9

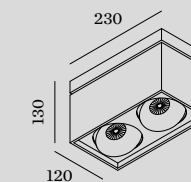

## 2.0 PAR16

2x PAR16 max. 12W | GU10  
100-240VAC | 50-60Hz  
aluminium

IP20 0°-35°/355° 1.51kg

CODE
139220W0
139220E0
139220B0

## OPTIONAL

PAR16 6.5W | GU10 | phase-cut dim

CODE	
2700K   460lm	901228W3
2700K   437lm	901228B3
3000K   500lm	901228W5
3000K   457lm	901228B5

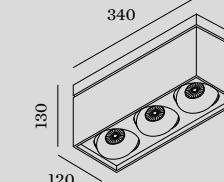

## 3.0 PAR16

3x PAR16 max. 12W | GU10  
100-240VAC | 50-60Hz  
aluminium

IP20 0°-35°/355° 1.91kg

CODE
139320W0
139320E0
139320B0

## OPTIONAL

PAR16 6.5W | GU10 | phase-cut dim

CODE	
2700K   460lm	901228W3
2700K   437lm	901228B3
3000K   500lm	901228W5
3000K   457lm	901228B5



# LECA

Ceiling surface

new



109

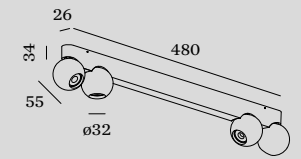
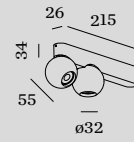
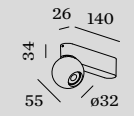
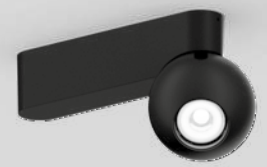

honeycomb

## OPTIONAL

honeycomb louver

CODE 90051131

### 1.0

LED COB 8W | phase-cut dim  
220-240VAC | 50-60Hz | incl. driver  
aluminium

IP20 0°-90°/350° A 31° SDCM2 L70|55K 0.40kg

2700K | CRI >90 | 510lm

CODE	CODE
188264W3	188264Q3
188264B3	188264B3

### 2.0

LED COB 15W | phase-cut dim  
220-240VAC | 50-60Hz | incl. driver  
aluminium

IP20 0°-90°/350° A 31° SDCM2 L70|55K 0.74kg

2700K | CRI >90 | 2x510lm

CODE	CODE
188364W3	188364Q3
188364B3	188364B3

### 4.0

LED COB 29W | phase-cut dim  
220-240VAC | 50-60Hz | incl. driver  
aluminium

IP20 0°-90°/350° A 31° SDCM2 L70|55K 1.50kg

2700K | CRI >90 | 4x510lm

CODE	CODE
188464W3	188464B3

Rev. 001/2024-05

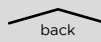

back





PRIVATE RESIDENCE | STUDIO ZUYD THE NETHERLANDS

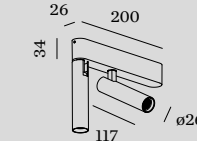
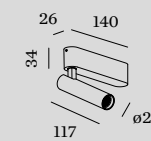

**1.0**

LED LED COB9W | phase-cut dim  
220-240VAC | 50-60Hz | incl. driver  
aluminium

⊕ IP20 0°-90°/350° ∠ 30° SDCM2 L80|50K 0.24kg

CODE	
	177154W_
	177154BL_
	177154B_

LIGHT COLOUR	LUMEN CRI	CODE
2700K	535 >90	3
3000K	560 >90	5

**2.0**

LED LED COB18W | phase-cut dim  
220-240VAC | 50-60Hz | incl. driver  
aluminium

⊕ IP20 0°-90°/350° ∠ 30° SDCM2 L80|50K 0.42kg

CODE	
	177254W_
	177254BL_
	177254B_

LIGHT COLOUR	LUMEN CRI	CODE
2700K	2x535 >90	3
3000K	2x560 >90	5

MATCH

Ceiling surface



reddot winner 2023



As awarded by The Chicago Athenaeum:  
Museum of Architecture and Design

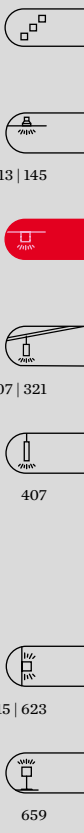

57 | 113 | 145

307 | 321

407

515 | 623

659

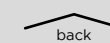

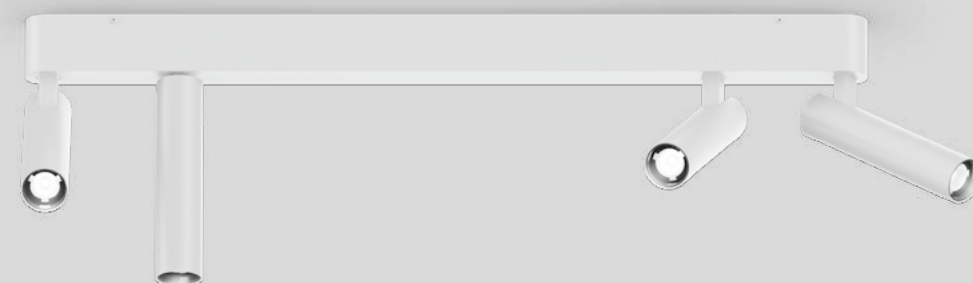
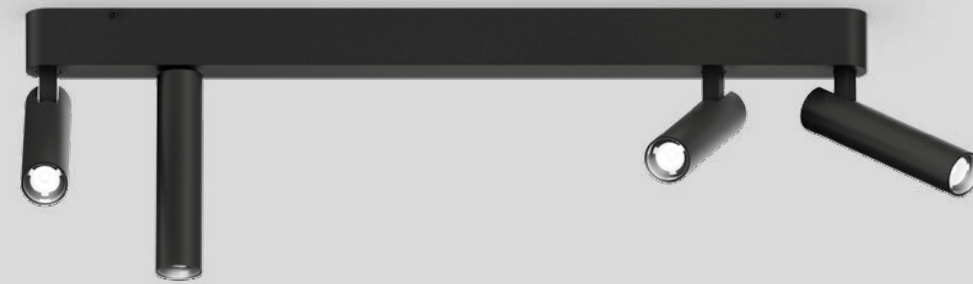

# MATCH

Ceiling surface

new

57 | 113 | 145

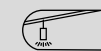

307 | 321

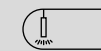

407



515 | 623



659

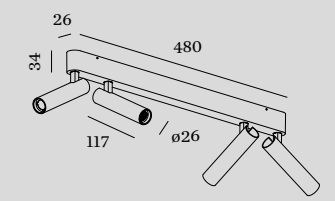

## 4.0

LED COB 30W | phase-cut dim  
220-240VAC | 50-60Hz | incl. driver  
aluminium

IP20 0°-90°/350° A30° SDCM2 L80I50K 0.86kg

### CODE

177454W\_

177454B\_

LIGHT COLOUR	LUMEN CRI	CODE
2700K	4x535 >90	3
3000K	4x560 >90	5

back



# CENO

Ceiling surface



As awarded by The Chicago Athenaeum: Museum of Architecture and Design

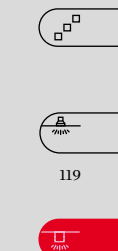

303 | 353



513

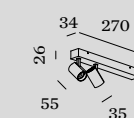
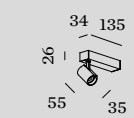
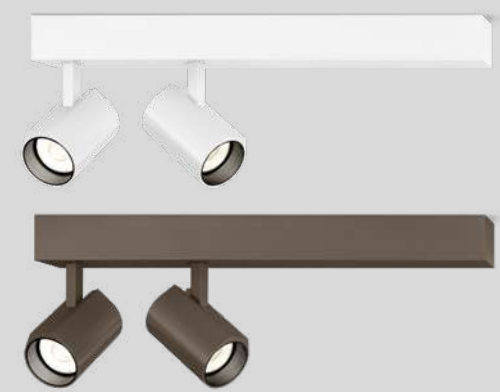

## 1.0

LED COB 9W | phase-cut dim  
220-240VAC | 50-60Hz | incl. driver  
aluminium

IP20 0°-90°/350° ∠ 31° SDCM2 L70/55K 0.21kg

## 2.0

LED COB 14W | phase-cut dim  
220-240VAC | 50-60Hz | incl. driver  
aluminium

IP20 0°-90°/350° ∠ 31° SDCM2 L70/55K 0.43kg

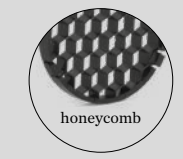

### OPTIONAL

honeycomb louver



CODE	
	176664W_
	176664Q_
	176664K_
	176664B_

CODE	
	176764W_
	176764Q_
	176764K_
	176764B_

CODE	LIGHT COLOUR	LUMEN CRI	CODE
90051131	2700K	470 >90	3
	3000K	500 >90	5

CODE	LIGHT COLOUR	LUMEN CRI	CODE
	2700K	2x470 >90	3
	3000K	2x500 >90	5

back





# CENO

Ceiling surface

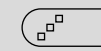
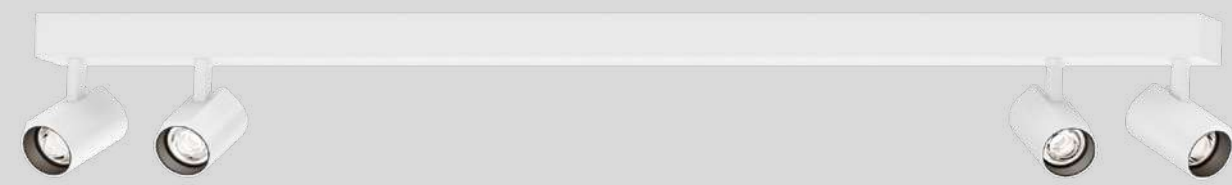

119

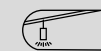

303 | 353



513

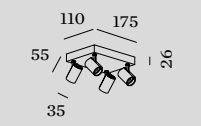
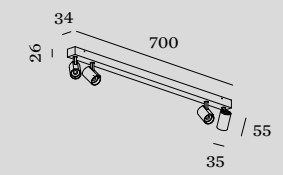

## 4.0

LED COB 30W | phase-cut dim  
220-240VAC | 50-60Hz | incl. driver  
aluminium

IP20 0°-90°/350° A 31° SDCM2 L70/55K 0.95kg

## 4.1

LED COB 30W | phase-cut dim  
220-240VAC | 50-60Hz | incl. driver  
aluminium

IP20 0°-90°/350° A 31° SDCM2 L70/55K 0.78kg

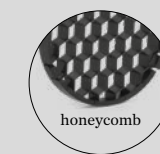

### OPTIONAL

honeycomb louver



	CODE
	176864W_
	176864Q_
	176864K_
	176864B_

	CODE
	176964W_
	176964Q_
	176964K_
	176964B_

CODE	LIGHT COLOUR	LUMEN CRI	CODE
	2700K	4x470 >90	3
90051131	3000K	4x500 >90	5

CODE	LIGHT COLOUR	LUMEN CRI	CODE
	2700K	4x470 >90	3
	3000K	4x500 >90	5

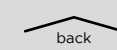



# CENO

Ceiling surface

new

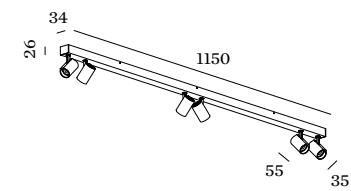
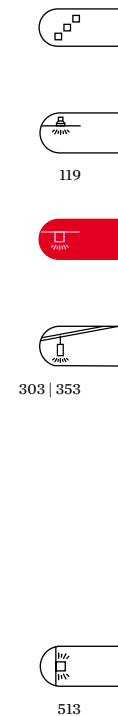

## 6.0

LED COB 42W | phase-cut dim  
220-240VAC | 50-60Hz | incl. driver  
aluminium

IP20 0°-90°/350° A: 31° SDCM2 L70/55K 1.34kg

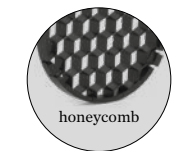

### OPTIONAL

honeycomb louver



CODE
176064W_
176064Q_
176064B_

LIGHT COLOUR	LUMEN CRI	CODE
2700K	6x470 >90	3
3000K	6x500 >90	5

CODE
90051131



# BLIEK petit

Ceiling surface



reddot winner 2023



123

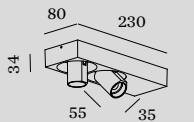

## 2.0

LED COB 15W | phase-cut dim  
220-240VAC | 50-60Hz | incl. driver  
aluminium

IP20 0°-60°/355° A 31° SDCM2 L70/55K 0.65kg

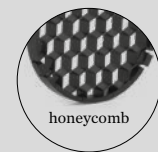

honeycomb

### OPTIONAL

honeycomb louver



CODE

90051131

CODE

164664W\_

164664CH\_

164664B\_

LIGHT COLOUR	LUMEN	CRI	CODE
2700K	2x470	>90	3
3000K	2x500	>90	5
2000-3000K	2x355	>90	9

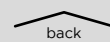

back



# MICK

Ceiling surface



As awarded by The Chicago Athenaeum: Museum of Architecture and Design



reddot winner 2020 lighting design

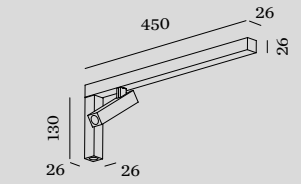
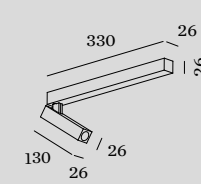
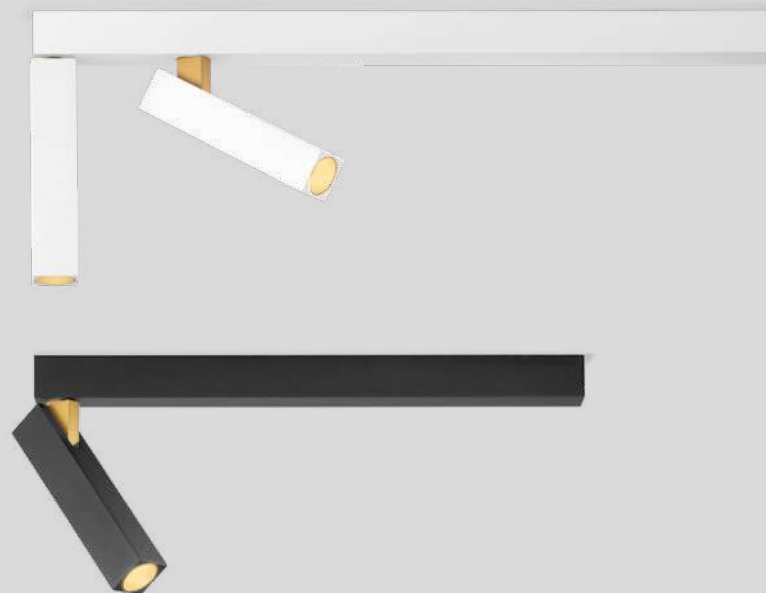

## 1.0

LED COB 14W | phase-cut dim  
220-240VAC | 50-60Hz | incl. driver  
aluminium

IP20 0°-90°/350° 23° SDCM2 L80|50K 0.35kg

CODE	
	159144J_
	159144K_

LIGHT COLOUR	LUMEN CRI	CODE
2700K	400 >90	3
3000K	435 >90	5

## 2.0

LED COB 14W | phase-cut dim  
220-240VAC | 50-60Hz | incl. driver  
aluminium

IP20 0°-90°/350° 23° SDCM2 L80|50K 0.62kg

CODE	
	159244J_
	159244K_

LIGHT COLOUR	LUMEN CRI	CODE
2700K	2x225 >90	3
3000K	2x245 >90	5





► DESIGN WITH LOVE



MARBELLA DESIGN & ART FAIR | MARISA GALLO | INTERIORISMO STUDIO MARBELLA | SPAIN

# SARA on base

Ceiling surface

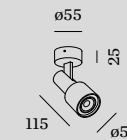

## 1.0

PAR16 max. 12W | GU10  
100-240VAC | 50-60Hz  
aluminium

⊕ IP20 0°-90° 0.23kg

CODE	
	157220W0
	157220G0
	157220K0
	157220B0

## OPTIONAL

PAR16 6.5W | GU10 | phase-cut dim

CODE	
	2700K   460lm 901228W3
	2700K   437lm 901228B3
	3000K   500lm 901228W5
	3000K   457lm 901228B5

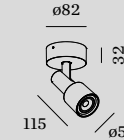

## 1.1

PAR16 max. 12W | GU10  
100-240VAC | 50-60Hz  
aluminium

⊕ IP20 0°-90°/330° 0.32kg

CODE	
	157420W0
	157420B0

## OPTIONAL

PAR16 6.5W | GU10 | phase-cut dim

CODE	
	2700K   460lm 901228W3
	2700K   437lm 901228B3
	3000K   500lm 901228W5
	3000K   457lm 901228B5

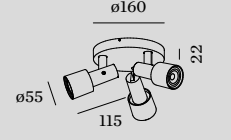

## 3.0

3x PAR16 max. 12W | GU10  
100-240VAC | 50-60Hz  
aluminium

⊕ IP20 0°-90°/330° 0.74kg

CODE	
	157520W0
	157520B0

## OPTIONAL

PAR16 6.5W | GU10 | phase-cut dim

CODE	
	2700K   460lm 901228W3
	2700K   437lm 901228B3
	3000K   500lm 901228W5
	3000K   457lm 901228B5

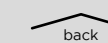



PRIVATE RESIDENCE | CBA & MAX BAUER - CBA.LU - BAUERGROUP.LU LUXEMBOURG

# SQUBE on base

Ceiling surface

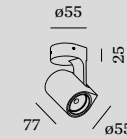

## 1.0 LED

LED COB 6W | phase-cut dim  
220-240VAC | 50-60Hz  
aluminium

⊕ IP20 0°-90° ∠39° SDCM3 L70|55K 0.43kg

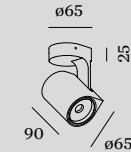

## 1.1 LED

LED COB 12W | phase-cut dim  
220-240VAC | 50-60Hz  
aluminium

⊕ IP20 0°-90° ∠32° SDCM3 L70|55K 0.44kg

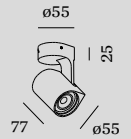

## 1.0 PAR16

PAR16 max. 12W | GU10  
100-240VAC | 50-60Hz  
aluminium

⊕ IP20 0°-90° 0.43kg



black ring  
LED



PAR16

CODE			
			144268W_
			144268B_

LIGHT COLOUR	LUMEN CRI	CODE
2700K	415 >90	3
3000K	430 >90	5
1800-3000K	350 >80	9

CODE			
			144468W_
			144468B_

LIGHT COLOUR	LUMEN CRI	CODE
2700K	940 >90	3
3000K	970 >90	5
1800-3000K	640 >80	9

CODE			
			144220W0
			144220B0

## OPTIONAL

PAR16 6.5W   GU10   phase-cut dim			
CODE			
	2700K   460lm		901228W3
	2700K   437lm		901228B3
	3000K   500lm		901228W5
	3000K   457lm		901228B5

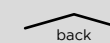

back



337 | 351





# SQUBE on base

Ceiling surface

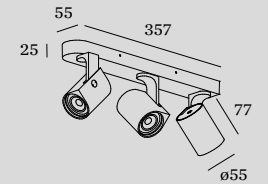
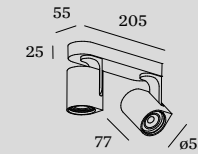

## 2.0

2x PAR16 max. 12W | GU10  
100-240VAC | 50-60Hz  
aluminium

⊕ IP20 0°-90°/355° 0.58kg

CODE

144520W0  
144520B0

## OPTIONAL

PAR16 6.5W | GU10 | phase-cut dim

CODE	
2700K   460lm	901228W3
2700K   437lm	901228B3
3000K   500lm	901228W5
3000K   457lm	901228B5

## 3.0

3x PAR16 max. 12W | GU10  
100-240VAC | 50-60Hz  
aluminium

⊕ IP20 0°-90°/355° 0.93kg

CODE

144620W0  
144620B0

## OPTIONAL

PAR16 6.5W | GU10 | phase-cut dim

CODE	
2700K   460lm	901228W3
2700K   437lm	901228B3
3000K   500lm	901228W5
3000K   457lm	901228B5



337 | 351

THESE TWO MAKE ALL YOUR WISHES COME TRUE

## Our *magic sticks*

Wouldn't it be nice to have two magic wands instead of one? This wish can easily come true with our SPIN variants. The two swivelling arms can be flexibly adapted to any situation, ensuring perfect illumination at all times. The great thing is that all three can be combined with different designs, offering endless design options. Those who prefer soft, indirect light can create a warm, Scandinavian-inspired atmosphere with SPIN PERLEZ. For a more minimalist look and direct, downward-directed light, small spotlights such as TRACE are ideal. Would you also like to creatively stage your walls? Then you can even create your own work of art with FIL SPIN wall surface.

Wäre es nicht schön, wenn man statt eines Zauberstabs gleich zwei davon hätte? Mit unseren SPIN-Varianten lässt sich dieser Wunsch ganz leicht erfüllen. Denn die beiden schwenkbaren Arme passen sich ganz flexibel an jede Situation an und sorgen so immer für die perfekte Ausleuchtung. Das Schöne daran: Alle drei lassen sich mit verschiedenen Designs kombinieren und bieten so unendlich viele Gestaltungsmöglichkeiten. Wer eher sanftes, indirektes Licht bevorzugt, kann mit SPIN PERLEZ eine warme, skandinavisch inspirierte Atmosphäre erzeugen. Für einen eher minimalistischen Look und direktes, nach unten gerichtetes Licht sind kleine Spots wie die von TRACE optimal. Sie möchten auch Ihre Wände kreativ in Szene setzen? Dann können Sie mit FIL SPIN Wall Surface sogar Ihr eigenes Kunstwerk gestalten.

<b>FIL SPIN</b>	Ceiling surface	p. 251
<b>TRACE SPIN</b>	Ceiling surface	p. 253
<b>PERLEZ SPIN</b>	Ceiling surface	p. 255
<b>FIL SPIN</b>	Wall surface	p. 615

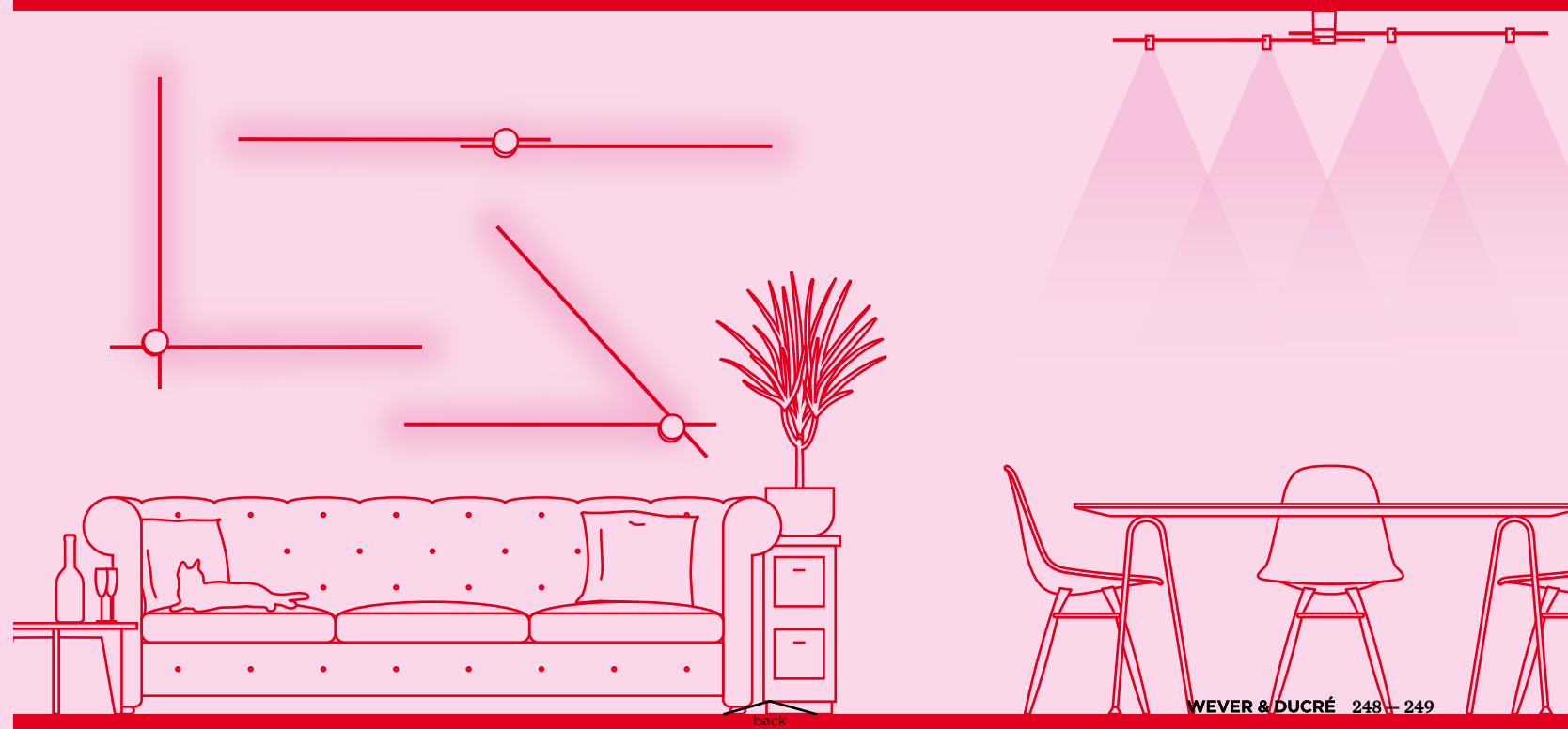
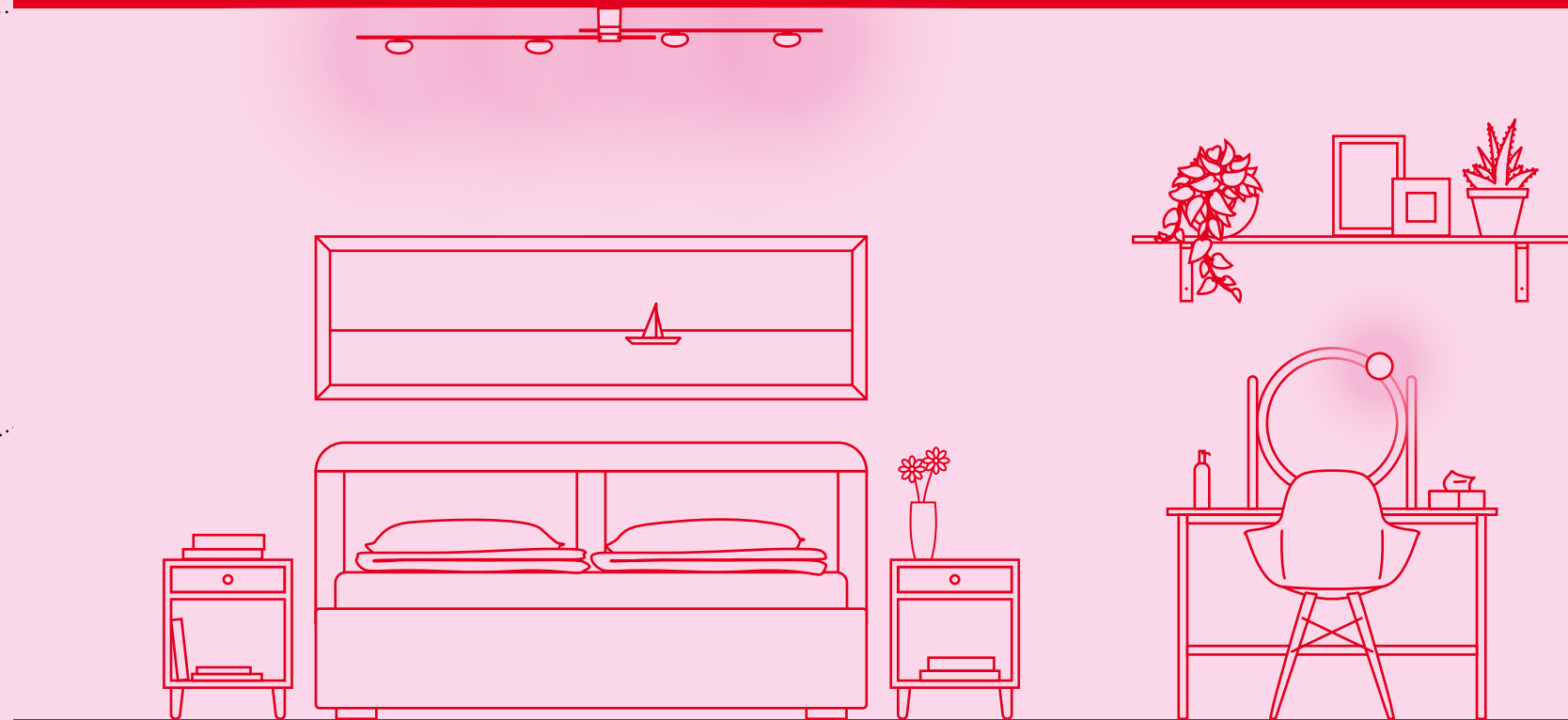
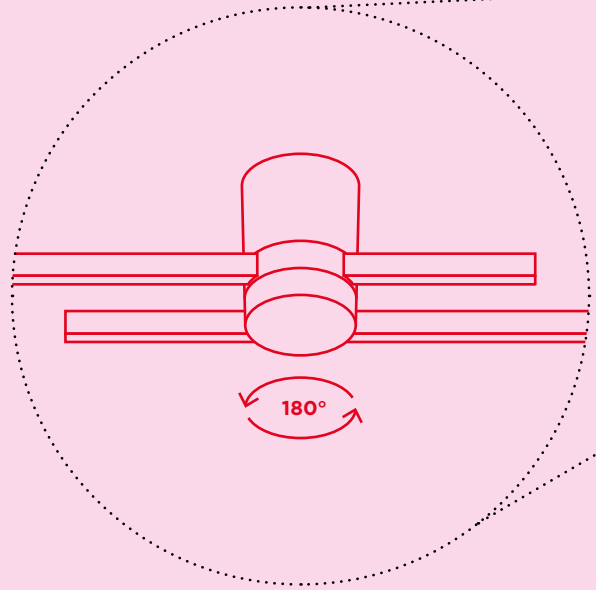



Rev. 001/2024-05

# FIL SPIN

Ceiling surface

new

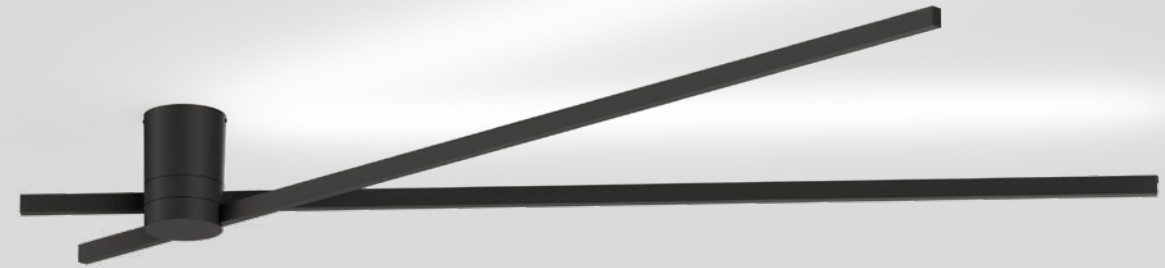

383

615

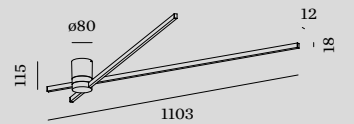

## 1.0

LED PCB 23W | phase-cut dim  
220-240VAC | 50-60Hz | incl. driver  
aluminium | indir. light

IP20 180° SDCM2 L80|50K 0.95kg

2700K | CRI >90 | 2x1050lm

CODE

254584B3

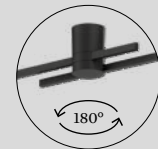

back



Rev. 001/2024-05

# TRACE SPIN

Ceiling surface

new



373 | 399



517

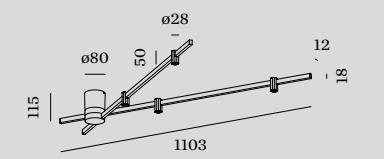

## 1.0

LED COB 25W | phase-cut dim  
220-240VAC | 50-60Hz | incl. driver  
aluminium

IP20 180°  $\Delta$ 30° SDCM2 L80|50K 1.07kg

2700K | CRI >90 | 4x430lm

CODE

183264CH3  
183264B3



back





Rev. 001/2024-05

# PERLEZ SPIN

Ceiling surface

new

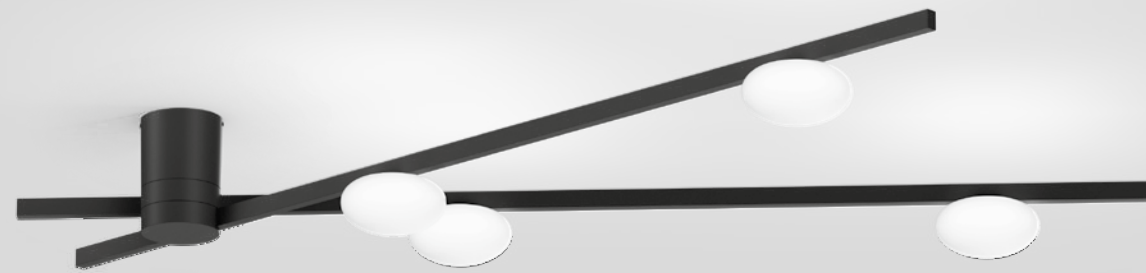

155



635

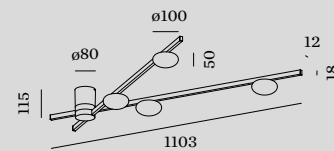

## 1.0

LED COB 25W | phase-cut dim  
220-240VAC | 50-60Hz | incl. driver  
aluminium | opal glass

IP20 180° SDCM2 L80|50K 1.49kg

2700K | CRI >90 | 4x250lm

CODE

192784BW3

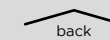
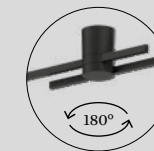

back

WEVER & DUCRÉ 254 — 255



# TRACE GRID

Ceiling surface

new

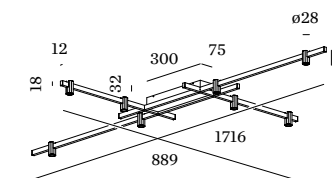
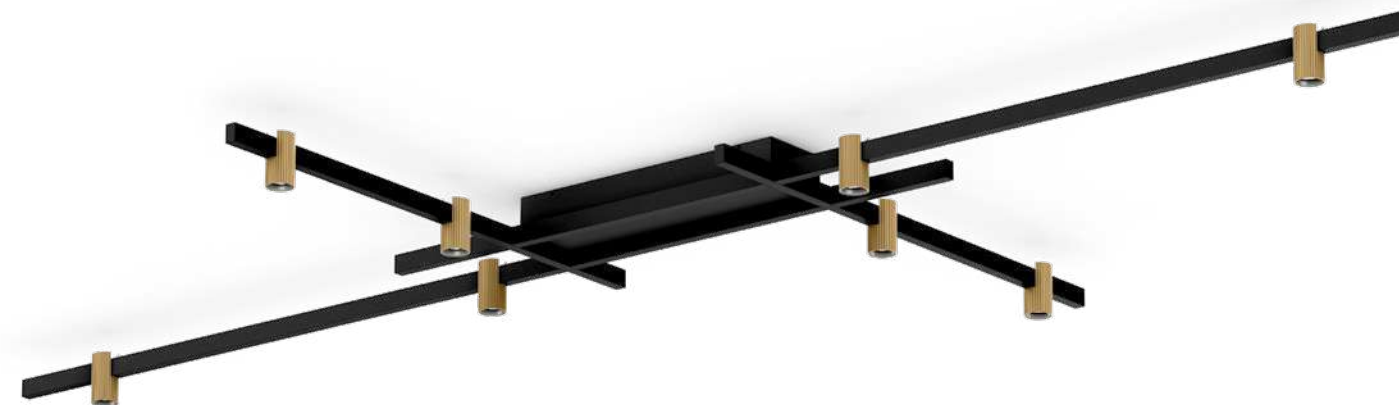

## 1.0

LED COB 40W | phase-cut dim  
220-240VAC | 50-60Hz | incl. driver  
aluminium  
direct light

⊕ IP20  $\Delta$  30° SDCM2 L80/50K 1.50kg

2700K | CRI >90 | 8x400lm

CODE  
183364CH3  
183364B3

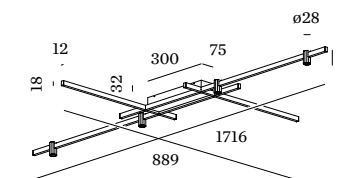

## 2.0

LED PCB/COB 26W | phase-cut dim  
220-240VAC | 50-60Hz | incl. driver  
aluminium  
dir./indir. light

⊕ IP20  $\Delta$  30° SDCM2 L80/50K 1.41kg

2700K | CRI >90 | 4x400/2x340lm

CODE  
183464CH3  
183464B3

back

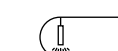
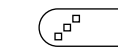

373 | 399

517



# PERLEZ GRID

Ceiling surface

new

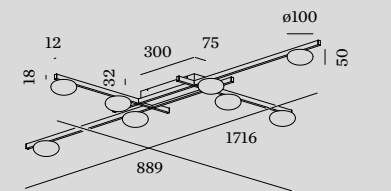
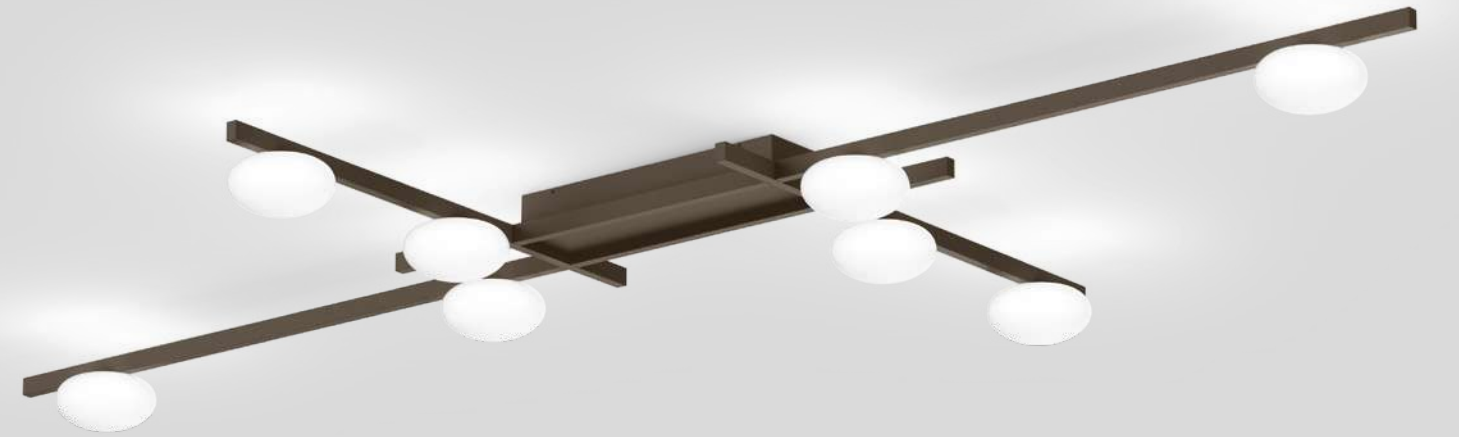

1.0

LED COB 40W | phase-cut dim  
220-240VAC | 50-60Hz | incl. driver  
aluminium | opal glass  
direct light

IP20 SDCM2 L80I50K 2.34kg

2700K | CRI >90 | 8x220lm

	CODE
	192884QW3
	192884BW3

back



# VENN

Ceiling surface

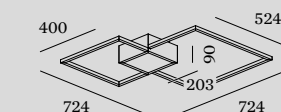
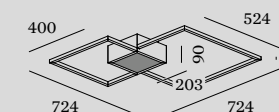
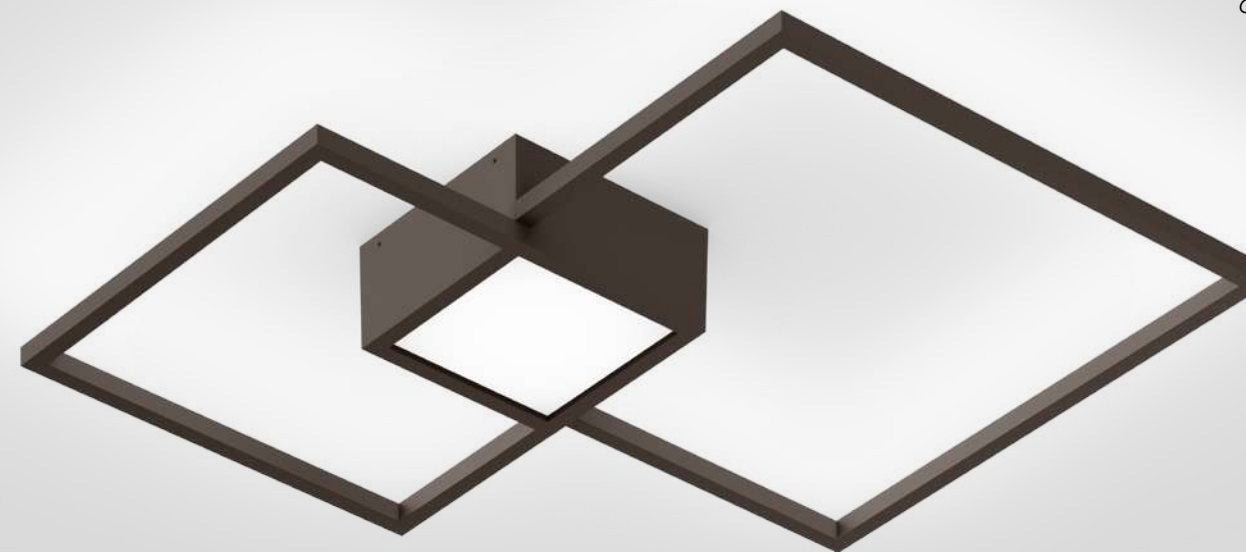

## 1.0

LED PCB 42W | phase-cut dim  
220-240VAC | 50-60Hz | incl. driver  
aluminium  
opal PMMA cover indirect light

IP20 SDCM3 L70|55K 2.50kg

## 2.0

LED PCB 49W | phase-cut dim  
220-240VAC | 50-60Hz | incl. driver  
aluminium  
opal PMMA cover dir./indir. light

IP20 SDCM3 L70|55K 2.50kg

CODE
149184W_
149184Q_
149184B_

LIGHT COLOUR	LUMEN CRI	CODE
2700K	3410 >80	2
3000K	3510 >80	4

CODE
149284W_
149284Q_
149284B_

LIGHT COLOUR	LUMEN CRI	CODE
2700K	480 3440 >80	2
3000K	495 3540 >80	4



CREATE YOUR OWN VENN  
weverducre.com/venn-configurator

Rev. 001/2024-05  
S&R CORNELISSEN

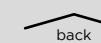

back





# DRO

Ceiling surface

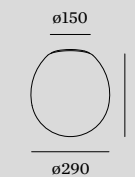
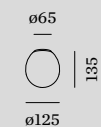
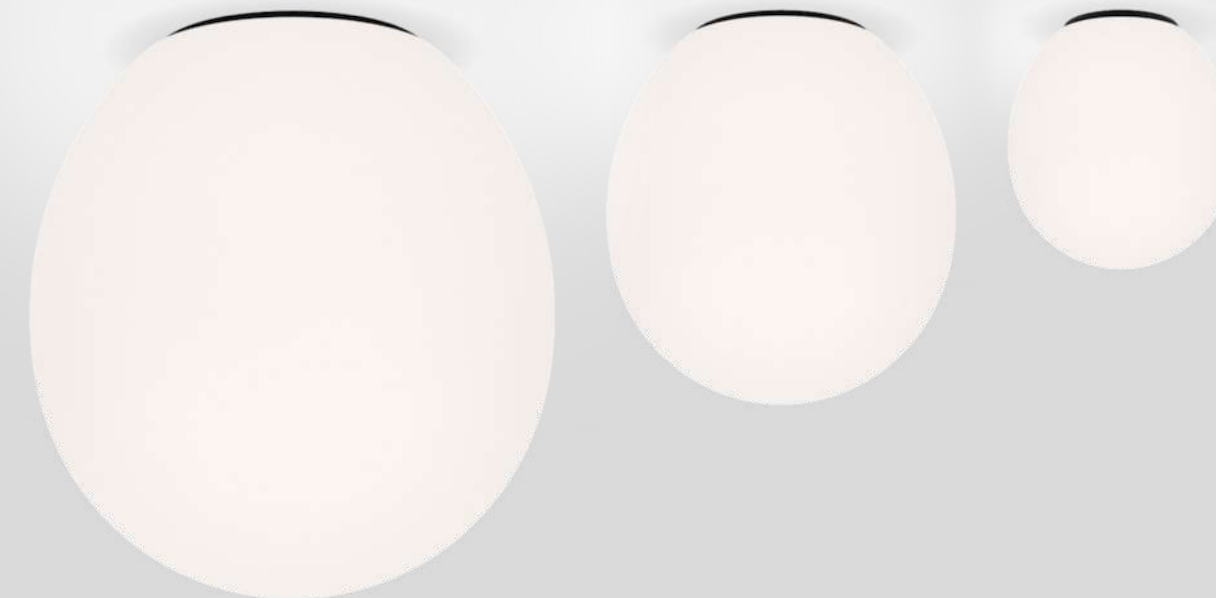

## 1.0

QT14 max. 5W | G9  
220-240VAC | 50-60Hz  
aluminium  
artisanal Italian hand blown glass

⊕ IP20 0.32kg

CODE  
1721G0WB0

## 2.0

C35 max. 6W | E14  
220-240VAC | 50-60Hz  
aluminium  
artisanal Italian hand blown glass

⊕ IP20 0.89kg

CODE  
1722C0WB0

## 3.0

A60 max. 12W | E27  
220-240VAC | 50-60Hz  
aluminium  
artisanal Italian hand blown glass

⊕ IP20 1.96kg

CODE  
1723E0WB0

### OPTIONAL

QT14 3W | G9 | phase-cut dim | clear  
CODE  
2700K | 300lm 9010G802  
3000K | 280lm 9010G804

### OPTIONAL

C35 5.5W | E14 | phase-cut dim | opal  
CODE  
2700K | 450lm 9003C103

### OPTIONAL

A60 9W | E27 | phase-cut dim | opal  
CODE  
2700K | 800lm 9003E152

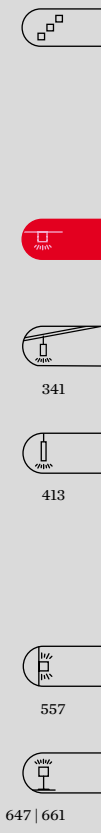



# WIRO

Ceiling surface

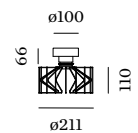

## 2.0 WIRO

A60 max. 60W | E27  
220-240VAC | 50-60Hz  
aluminium | steel

IP20 0.78kg

	CODE
	2086E0V0
	2086E0B0

## OPTIONAL

A60 3.8W | E27 | phase-cut dim  
gold tinted

	CODE
2200K   247lm	9003E109

A60 5.6W | E27 | phase-cut dim | clear

	CODE
2700K   483lm	9003E138

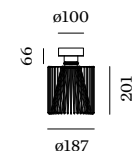

## 1.8 WIRO

T30 max. 25W | E27  
220-240VAC | 50-60Hz  
aluminium | steel

IP20 1.66kg

	CODE
	2082E0V0
	2082E0B0

## OPTIONAL

T30-225 5.3W | E27 | phase-cut dim  
gold tinted

	CODE
2200K   382lm	9003E129
2700K   425lm	9003E136

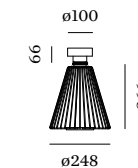

## 1.0 CONE

T30 max. 60W | E27  
220-240VAC | 50-60Hz  
aluminium | steel

IP20 1.56kg

	CODE
	2080E0V0
	2080E0B0

## OPTIONAL

T30-225 5.3W | E27 | phase-cut dim  
gold tinted

	CODE
2200K   382lm	9003E129
2700K   425lm	9003E136

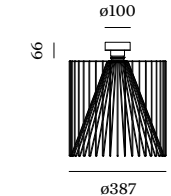

## 3.8 WIRO

T30 max. 60W | E27  
220-240VAC | 50-60Hz  
aluminium | steel

IP20 2.71kg

	CODE
	2083E0V0
	2083E0B0

## OPTIONAL

T30-225 5.3W | E27 | phase-cut dim  
gold tinted

	CODE
2200K   382lm	9003E129
2700K   425lm	9003E136



# MIRRO

Ceiling surface

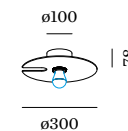
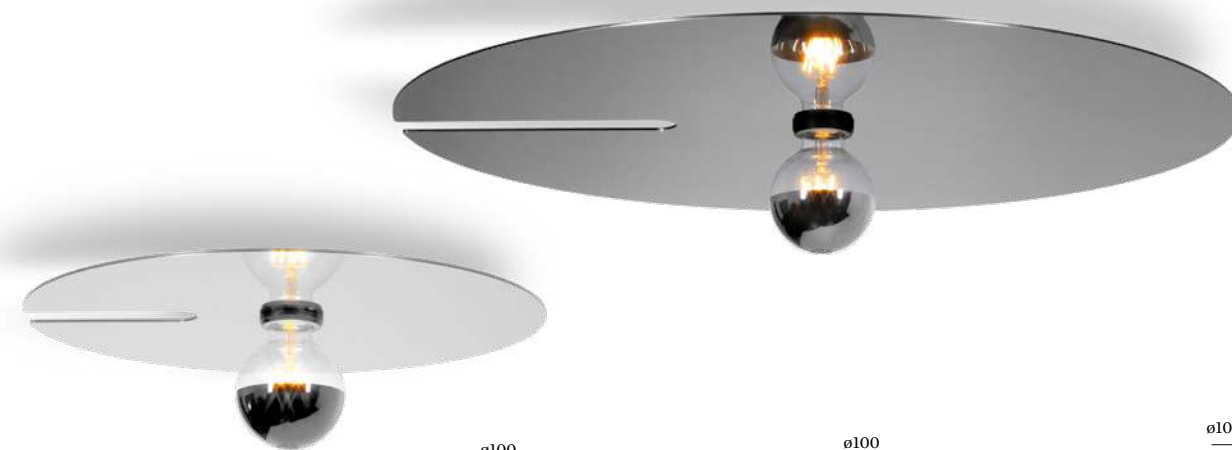

## 1.0

◁ A60 max. 15W | E27  
220-240VAC | 50-60Hz  
aluminium  
one side reflective composite panel

⊕ IP20 0.70kg

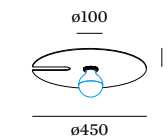

## 2.0

◁ G95 max. 15W | E27  
220-240VAC | 50-60Hz  
aluminium  
one side reflective composite panel

⊕ IP20 1.00kg

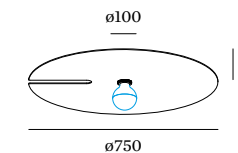

## 3.0

◁ G95 max. 15W | E27  
220-240VAC | 50-60Hz  
aluminium  
one side reflective composite panel

⊕ IP20 2.10kg

CODE	
	6321E0GB0
	6321E0NB0
	6321E0LB0

CODE	
	6322E0GB0
	6322E0NB0
	6322E0LB0

CODE	
	6323E0GB0
	6323E0NB0
	6323E0LB0

## OPTIONAL

A60 5.1W | E27 | phase-cut dim  
gold mirror

CODE	
2700K   409lm	9003E139

A60 5.5W | E27 | phase-cut dim  
silver mirror

CODE	
2700K   409lm	9003E140

## OPTIONAL

G95 5.1W/5.6W | E27 | phase-cut dim  
gold mirror

CODE	
2200K   371lm	9003E156
2700K   464lm	9003E142

G95 5.6W | E27 | phase-cut dim  
silver mirror

CODE	
2700K   464lm	9003E157

## OPTIONAL

G95 5.1W/5.6W | E27 | phase-cut dim  
gold mirror

CODE	
2200K   371lm	9003E156
2700K   464lm	9003E142

G95 5.6W | E27 | phase-cut dim  
silver mirror

CODE	
2700K   464lm	9003E157



# MIRRO SOFT

Ceiling surface

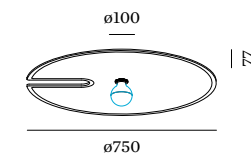
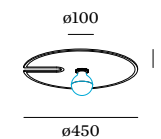

## 2.0





G95 max. 15W | E27  
220-240VAC | 50-60Hz  
aluminium | PET felt material





IP20 0.67kg

## 3.0

G95 max. 15W | E27  
220-240VAC | 50-60Hz  
aluminium | PET felt material

IP20 1.20kg

CODE	
	6322E0MF0
	6322E0LF0
	6322E0IF0
	6322E0AF0

CODE	
	6323E0MF0
	6323E0LF0
	6323E0IF0
	6323E0AF0

## OPTIONAL

G95 5.1W/5.6W | E27 | phase-cut dim  
gold mirror

CODE	
2200K   371lm	9003E156
2700K   464lm	9003E142

G95 5.6W | E27 | phase-cut dim  
silver mirror

CODE	
2700K   464lm	9003E157

G95 5.5W | E27 | phase-cut dim  
clear

CODE	
2700K   534lm	9003E160

## OPTIONAL

G95 5.1W/5.6W | E27 | phase-cut dim  
gold mirror

CODE	
2200K   371lm	9003E156
2700K   464lm	9003E142

G95 5.6W | E27 | phase-cut dim  
silver mirror

CODE	
2700K   464lm	9003E157

G95 5.5W | E27 | phase-cut dim  
clear

CODE	
2700K   534lm	9003E160







CLEA

Ceiling surface

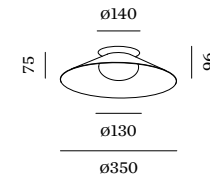

1.0

LED COB 14W | phase-cut dim  
220-240VAC | 50-60Hz | incl. driver  
aluminium  
white opal glass hand blown

IP20 SDCM2 L80|50K 0.78kg

CODE
181184W_
181184LS_
181184SG_
181184FJ_
181184B_

LIGHT COLOUR	LUMEN	CRI	CODE
2700K	810	>90	3
3000K	835	>90	5

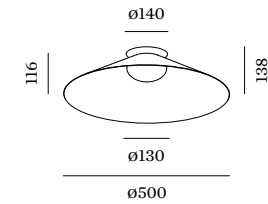

2.0

LED COB 14W | phase-cut dim  
220-240VAC | 50-60Hz | incl. driver  
aluminium  
white opal glass hand blown

IP20 SDCM2 L80|50K 1.31kg

CODE
181284W_
181284LS_
181284SG_
181284FJ_
181284B_

LIGHT COLOUR	LUMEN	CRI	CODE
2700K	810	>90	3
3000K	835	>90	5

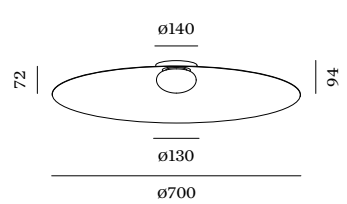

3.0

LED COB 14W | phase-cut dim  
220-240VAC | 50-60Hz | incl. driver  
aluminium  
white opal glass hand blown

IP20 SDCM2 L80|50K 2.09kg

CODE
181384W_
181384LS_
181384SG_
181384FJ_
181384B_

LIGHT COLOUR	LUMEN	CRI	CODE
2700K	810	>90	3
3000K	835	>90	5

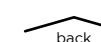

back

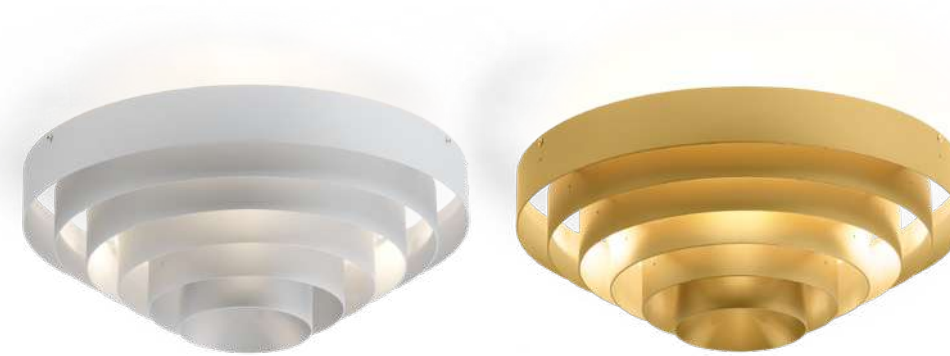

J.J.W.

Ceiling surface

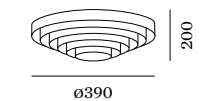

**O3**

3x A60 max. 15W | E27  
220-240VAC | 50-60Hz  
aluminium

IP20 4.00kg

	CODE 2051E0S0
	CODE 2051E0G0

**OPTIONAL**

A60 3.8W | E27 | phase-cut dim  
gold tinted

	CODE 2200K   247lm	CODE 9003E109
--	-----------------------	------------------

A60 5.6W | E27 | phase-cut dim | clear

	CODE 2700K   483lm	CODE 9003E138
--	-----------------------	------------------



URBAN SPACES | STUDIO KOMO STUTTGART | GERMANY

# ROOMOR OFFICE

Ceiling surface



reddot winner 2021



As awarded by The Chicago Athenaeum: Museum of Architecture and Design

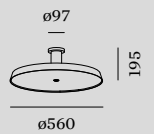

## 1.0 MICROPRISMATIC

LED PCB 35W | DALI-2 | push dim  
220-240VAC | 50-60Hz | incl. driver  
aluminium  
microprismatic PMMA cover

IP20 SDCM3 L80/60K UGR ≤ 19/65° 4.22kg

3000K | CRI >90 | 3660lm

CODE

1683M5W5  
1683M5B5

4000K | CRI >90 | 3660lm

CODE

1683M5W7  
1683M5B7

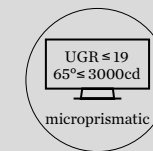

## 1.0 OPAL

LED PCB 35W | DALI-2 | push dim  
220-240VAC | 50-60Hz | incl. driver  
aluminium  
opal PMMA cover

IP20 SDCM3 L80/60K 4.22kg

3000K | CRI >90 | 3700lm

CODE

168385W5  
168385B5

4000K | CRI >90 | 3700lm

CODE

168385W7  
168385B7

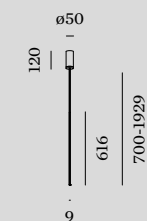

1.0

LED PCB 5W | phase-cut dim  
220-240VAC | 50-60Hz | incl. driver  
aluminium | opal PMMA diffuser

IP20 SDCM3 L80|50K 0.42kg

CODE	
	174184W_
	174184CH_
	174184B_

OPTIONAL

cover plate adapter for concrete housing	
CODE	
900194B0	

LIGHT COLOUR	LUMEN CRI	CODE
2700K	430 >90	3
3000K	440 >90	5

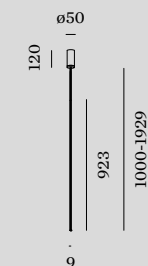

2.0

LED PCB 8W | phase-cut dim  
220-240VAC | 50-60Hz | incl. driver  
aluminium | opal PMMA diffuser

IP20 SDCM3 L80|50K 0.43kg

CODE	
	174284W_
	174284CH_
	174284B_

LIGHT COLOUR	LUMEN CRI	CODE
2700K	655 >90	3
3000K	670 >90	5

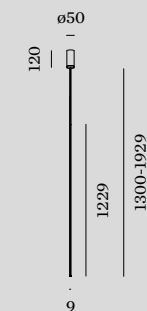

3.0

LED PCB 9W | phase-cut dim  
220-240VAC | 50-60Hz | incl. driver  
aluminium | opal PMMA diffuser

IP20 SDCM3 L80|50K 0.44kg

CODE	
	174384W_
	174384CH_
	174384B_

LIGHT COLOUR	LUMEN CRI	CODE
2700K	870 >90	3
3000K	890 >90	5



# PERLEZ IP44

Ceiling surface

new

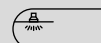
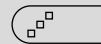

155



635

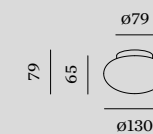

## 1.0

LED COB 8W | phase-cut dim  
220-240VAC | 50-60Hz | incl. driver  
aluminium | opal glass

IP44 SDCM3 L80|50K 0.39kg

CODE  
192484W\_

LIGHT COLOUR	LUMEN CRI	CODE
2700K	510 >95	3
3000K	540 >95	5

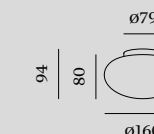

## 2.0

LED COB 8W | phase-cut dim  
220-240VAC | 50-60Hz | incl. driver  
aluminium | opal glass

IP44 SDCM3 L80|50K 0.49kg

CODE  
192584W\_

LIGHT COLOUR	LUMEN CRI	CODE
2700K	560 >95	3
3000K	590 >95	5

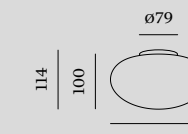

## 3.0

LED COB 8W | phase-cut dim  
220-240VAC | 50-60Hz | incl. driver  
aluminium | opal glass

IP44 SDCM3 L80|50K 0.67kg

CODE  
192684W\_

LIGHT COLOUR	LUMEN CRI	CODE
2700K	610 >95	3
3000K	650 >95	5

back



# TAIO IP65

Ceiling surface

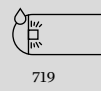
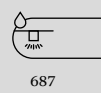
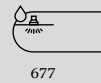
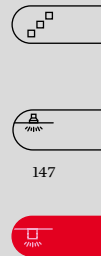

## 1.0

LED COB 12W | phase-cut dim  
220-240VAC | 50-60Hz | incl. driver  
aluminium  
opal glass convex lens

IP65 105° SDCM2 L80|55K 0.53kg

CODE	
	180884W_
	180884B_

LIGHT COLOUR	LUMEN CRI	CODE
2700K	450 >90	3
3000K	480 >90	5

[back](#)



PRIVATE RESIDENCE | IMORE INTERIEURARCHITECTUUR BELGIUM



# MIRBI IP44

Ceiling surface



157



643

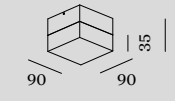

## 1.0

LED PCB 8W | phase-cut dim  
220-240VAC | 50-60Hz  
aluminium | clear and opal  
PMMA cover

⊕ IP44 SDCM3 L80I60K 0.4kg

3000K | CRI >90 | 660lm

	CODE
	175488W5
	175488BW5

## 2.0

LED PCB 8W | phase-cut dim  
220-240VAC | 50-60Hz  
aluminium | clear and opal  
PMMA cover

⊕ IP44 SDCM3 L80I60K 0.5kg

3000K | CRI >90 | 660lm

	CODE
	175588W5
	175588BW5

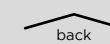



# ROB IP44

Ceiling surface

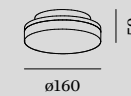

## 1.6

LED PCB 12W | phase-cut dim  
220-240VAC | 50-60Hz  
aluminium | opal PMMA cover

IP44 SDCM3 L80|60K 0.70kg

CODE  
701188W\_

LIGHT COLOUR	LUMEN CRI	CODE
2700K	1170 >90	3
3000K	1220 >90	5

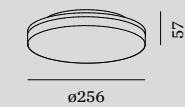

## 2.6

LED PCB 18W | phase-cut dim  
220-240VAC | 50-60Hz  
aluminium | opal PMMA cover

IP44 SDCM3 L80|60K 1.20kg

CODE  
701288W\_

LIGHT COLOUR	LUMEN CRI	CODE
2700K	1800 >90	3
3000K	1810 >90	5

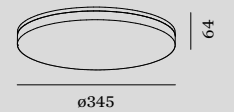

## 3.5

LED PCB 32W | phase-cut dim  
220-240VAC | 50-60Hz  
aluminium | opal PMMA cover

IP44 SDCM3 L80|60K 1.90kg

CODE  
701388W\_

LIGHT COLOUR	LUMEN CRI	CODE
2700K	3340 >90	3
3000K	3360 >90	5







# ROBY IP44

Ceiling surface

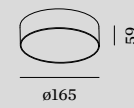

**1.6**

LED PCB 12W | phase-cut dim  
220-240VAC | 50-60Hz  
aluminium | opal PMMA cover

⊕ IP44 SDCM3 L80|60K 1.00kg

CODE	
White	135188W_
Black	135188B_

LIGHT COLOUR	LUMEN CRI	CODE
2700K	1080 >90	3
3000K	1130 >90	5

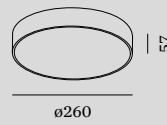

**2.6**

LED PCB 18W | phase-cut dim  
220-240VAC | 50-60Hz  
aluminium | opal PMMA cover

⊕ IP44 SDCM3 L80|60K 1.55kg

CODE	
White	135288W_
Black	135288B_

LIGHT COLOUR	LUMEN CRI	CODE
2700K	1670 >90	3
3000K	1680 >90	5

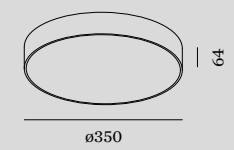

**3.5**

LED PCB 32W | phase-cut dim  
220-240VAC | 50-60Hz  
aluminium | opal PMMA cover

⊕ IP44 SDCM3 L80|60K 2.45kg

CODE	
White	135388W_
Black	135388B_

LIGHT COLOUR	LUMEN CRI	CODE
2700K	3090 >90	3
3000K	3010 >90	5

back



# TOWNA IP44

Ceiling surface

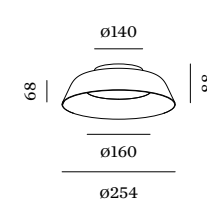
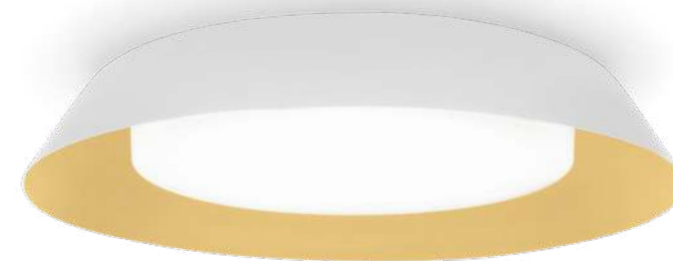

## 1.0

LED PCB 12W | phase-cut dim  
220-240VAC | 50-60Hz  
aluminium | steel  
opal PMMA cover

IP44 SDCM3 L80|60K 1.15kg

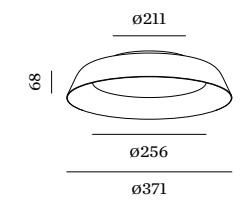

## 2.0

LED PCB 18W | phase-cut dim  
220-240VAC | 50-60Hz  
aluminium | steel  
opal PMMA cover

IP44 SDCM3 L80|60K 3.35kg

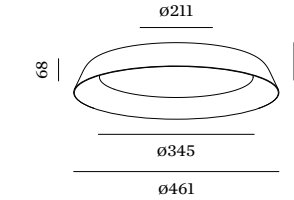

## 3.0

LED PCB 32W | phase-cut dim  
220-240VAC | 50-60Hz  
aluminium | steel  
opal PMMA cover

IP44 SDCM3 L80|60K 3.00kg

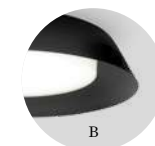
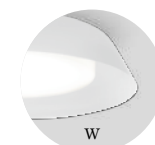

CODE
178188W_
178188J_
178188K_
178188Z_
178188B_

LIGHT COLOUR	LUMEN CRI	CODE
2700K	1070 >90	3
3000K	1110 >90	5

CODE
178288W_
178288J_
178288K_
178288Z_
178288B_

LIGHT COLOUR	LUMEN CRI	CODE
2700K	1650 >90	3
3000K	1660 >90	5

CODE
178388W_
178388J_
178388K_
178388Z_
178388B_

LIGHT COLOUR	LUMEN CRI	CODE
2700K	3050 >90	3
3000K	3060 >90	5

**STREX TRACKS**

<b>48V TRACKS</b> 295	<b>CENO</b> 303	<b>MATCH</b> 307	<b>MICK</b> 309	<b>BOX</b> 311
<b>DOCUS</b> 313	<b>HEXO</b> 315	<b>RAY</b> 317	<b>DOTS LIGHT MODULE</b> 319	<b>OPAL LIGHT MODULE</b> 319
<b>ODREY</b> 323	<b>SOLLI</b> 329			<b>MATCH</b> 321

**1-PHASE TRACKS**

<b>1-PHASE TRACKS</b> 331	<b>SARA</b> 333	<b>SQUBE</b> 337	<b>PIRRO SPOT</b> 339	<b>PIRRO OPAL</b> 339
<b>DRO</b> 341	<b>HEXO</b> 343	<b>RAY</b> 343	<b>ODREY</b> 345	

**3-PHASE TRACKS**

<b>3-PHASE TRACKS</b> 349	<b>SQUBE</b> 351	<b>CENO FORT</b> 353	<b>HEXO</b> 355	<b>RAY</b> 355

**ROOMOR OFFICE**  
357

**PIRRO SYSTEM**

**PIRRO SYSTEM**  
361

**ELLO SYSTEM**

**ELLO SYSTEM**  
363

**ILANE**

**ILANE**  
367

THREE WAYS TO MAKE THEM SHINE

# On the *right* track

It's normal to go off the rails when it comes to tracks. That's why we need a quick introduction. You can essentially choose between three options. The simplest is the 1-phase track. This system controls light sources from one point and switches them all on and off together. You'd prefer to operate each luminaire individually? Then we recommend the 3-phase track, where spotlights, insets, and suspended luminaires are connected and controlled separately. But there's also the 48-volt system. It allows spotlights and suspended luminaires, and also various sets of spots and opal insets for general lighting, to be inserted with ease. This means you can always react flexibly to changes in the room. The system can be easily controlled by your smartphone, which is especially practical.

Dass man bei Schienen erst mal Bahnhof versteht, ist ganz normal. Deshalb gibt's hier eine schnelle Einführung: Grundsätzlich können Sie zwischen drei Möglichkeiten wählen. Die einfachste ist die 1-Phasen-Schiene, bei der alle Lichtquellen von einem Punkt aus angesteuert und zusammen ein- und ausgeschaltet werden. Sie möchten Ihre Leuchten einzeln bedienen? Dann empfiehlt sich eine 3-Phasen-Schiene, bei der Strahler, Insets und Hängeleuchten separat angeschlossen und gesteuert werden. Weiters im Programm: das 48-Volt-System. Mit ihm lassen sich nicht nur Strahler oder Hängeleuchten, sondern auch verschiedene Spots- und Opalinsets – zur Allgemeinbeleuchtung ganz einfach einsetzen. So kann jederzeit flexibel auf Veränderungen im Raum reagiert werden. Besonders praktisch: das System lässt sich ganz bequem vom Smartphone aus steuern.



[weverducre.com/strex-configurator](https://weverducre.com/strex-configurator)

	<b>STREX system</b> 48V DALI page 295	<b>1-Phase tracks</b> 220-240V page 331	<b>3-Phase tracks</b> 220-240V page 349
<b>1 Choose your mounting</b>	<p>recessed surface suspended suspended indirect</p>	<p>recessed surface suspended</p>	<p>surface suspended</p>
<b>2 Install it in your layout</b>			
<b>3 Choose your driver</b>	<p>remote inline in track ceiling</p>		
<b>4 Combine it with insets</b>			

For more support and an extended layout of track systems, please check our FAQ section at [weverducre.com/faq](https://weverducre.com/faq)

# Choose your *mounting*



weverducre.com/strex-configurator

## Ceiling recessed

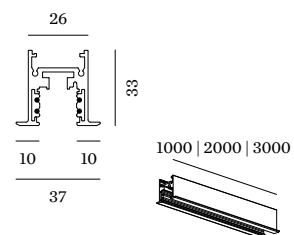
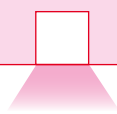

### M | MOUNTING BRACKET

recessed mounting bracket  
for 1m - 2pcs needed | for 2m - 4pcs  
needed | for 3m - 6pcs needed

#### STREX RECESSED

track 48V | 15A | DALI

SELV 31-33 65 5-25

CODE

90014193

	CODE
1m	90014187
1m	90014188
2m	90014189
2m	90014190
3m	90014191
3m	90014192

### E | END CAP

	CODE
27	90014149
27	90014150

## Ceiling surface

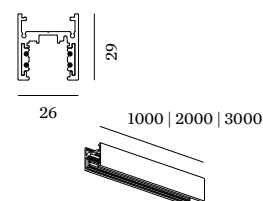
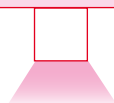

### STREX SURFACE

track 48V | 15A | DALI

SELV

	CODE
1m	90014181
1m	90014182
2m	90014183
2m	90014383
2m	90014384
2m	90014184
3m	90014185
3m	90014385
3m	90014386
3m	90014186

### E | END CAP

	CODE
29	90014147
29	90014347
29	90014348
29	90014148

## Ceiling suspended

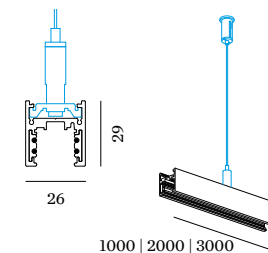
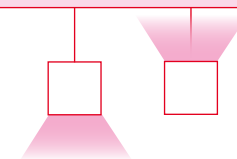

### STREX SUSPENDED

track 48V | 15A | DALI

SELV

	CODE
1m	90014181
1m	90014182
2m	90014183
2m	90014383
2m	90014384
2m	90014184
3m	90014185
3m	90014385
3m	90014386
3m	90014186

### STREX SUSP. INDIRECT

track 48V | 15A | DALI | with indirect  
light | 3.0m suspension sets already  
included | 15W/m

SELV

	CODE
3000K   CRI >90   1900lm	
2m	900140W5
2m	900140B5
3000K   CRI >90   2850lm	
3m	900141W5
3m	900141B5

## Custom cut available



Have a look on page 821 or browse  
online: [weverducre.com/strex-custom](http://weverducre.com/strex-custom)

### S | SUSPENSION SET

complete suspension set | incl. ceiling  
fixation bracket | not needed for  
indirect light version | for 1m - 2pcs  
needed | for 2m - 3pcs needed  
for 3m - 4pcs needed

stainless steel colour

	CODE
max. 1.5m	90014160
max. 3m	90014161

black colour

	CODE
max. 1.5m	90014274
max. 3m	90014275

### E | END CAP

	CODE
23	90014147
23	90014347
23	90014348
23	90014148

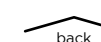

back

# Install it in your layout



weverducre.com/strex-configurator

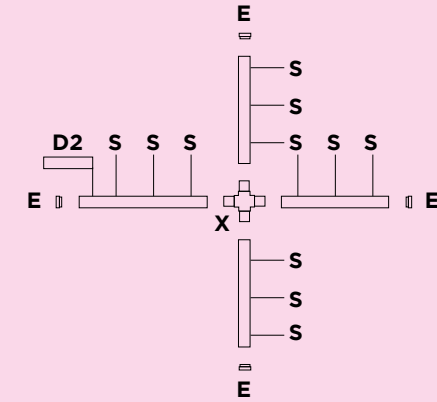
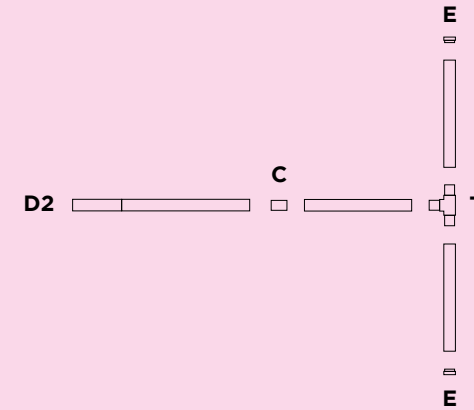
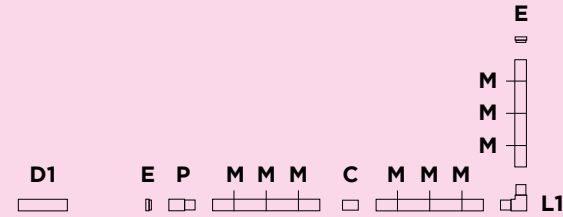

**M | S | E**  
Choose your mounting  
on page 295

**D | P**  
Choose your driver | power feed  
on page 299

**Good to know**  
Electrical components of champagne  
or bronze connectors and drivers will  
be black.

## All mountings

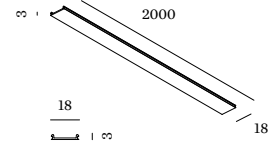

### BLANK COVER

	CODE
2m	911002W0
2m	911002B0

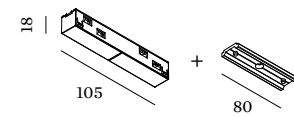

### C | CONNECTOR

48V | 15A | DALI | electrical/  
mechanical connector

	CODE
	90014196
	90014197

## Ceiling recessed

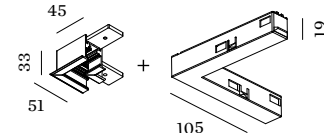

### L1 | L-CONNECTOR

48V | 15A | DALI | electrical/  
mechanical connector left and right

	CODE
	90014251
	90014252

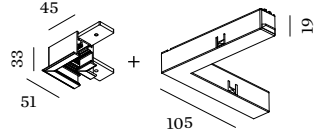

### L2 | L-CONNECTOR NON ELECTRICAL

only needed 1x for square installation

	CODE
	90014256
	90014257

## Ceiling surface / suspended

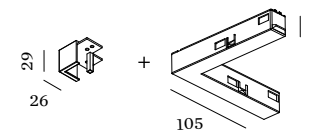

### L1 | L-CONNECTOR

48V | 15A | DALI | electrical/  
mechanical connector left and right

	CODE
	90014198
	90014398
	90014399
	90014199

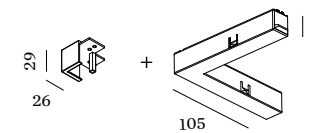

### L2 | L-CONNECTOR NON ELECTRICAL

only needed 1x for square installation

	CODE
	90014258
	90014458
	90014459
	90014259

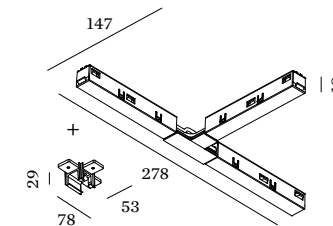

### T | T-CONNECTOR

48V | 15A | DALI | electrical/  
mechanical connector

	CODE
	90014292
	90014293

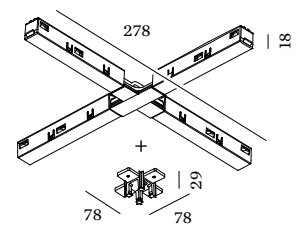

### X | X-CONNECTOR

48V | 15A | DALI | electrical/  
mechanical connector

	CODE
	90014295
	90014294

Rev. 001/2024-05

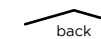

back

# Choose your *driver*

A driver regulates the current flowing through your LED lights, preventing overheating and unwanted flickering. Which is best suited to your STREX system depends on the chosen installation. The most elegant solution is an in-track driver, but many other variants are also available.

Ein Treiber reguliert den Stromfluss, der durch Ihre LED-Leuchten fließt und verhindert damit Überwärmung und störendes Flackern. Welcher am besten zu Ihrem STREX-System passt, hängt von der gewählten Montage ab. Die eleganteste Lösung ist ein In-Track-Treiber aber auch viele andere Varianten sind möglich.

## Good to know

Electrical components of champagne or bronze connectors and drivers will be black.

## Ceiling recessed / surface

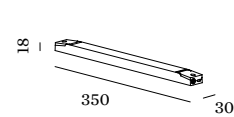

### D1 | REMOTE DRIVER

remote converter | 220-240VAC 50-60Hz | 48V | for connection to power feed adapter



CODE

100W   48V	90218901
150W   48V	90218902

for DALI SELV solution see page 821

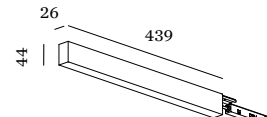

### D2 | IN LINE DRIVER SURFACE

220-240VAC | 50-60Hz | 48V incl. power end feed adapter incl. DALI through wiring

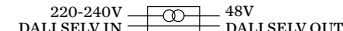

CODE

100W	90014366
100W	90014367
150W	90014370
150W	90014371

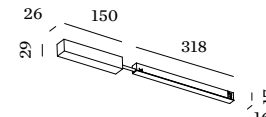

### D3 | IN TRACK DRIVER SURFACE

220-240VAC | 50-60Hz | 48V incl. power end feed function with in line connection box



CODE

100W	90014178
100W	90014378
100W	90014376
100W	90014176

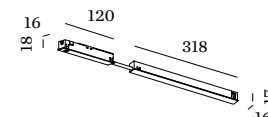

### D4 | IN TRACK DRIVER SURFACE

220-240VAC | 50-60Hz | 48V incl. power middle/end feed function with in track connection

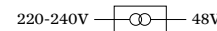

CODE

100W	90014144
100W	90014143

## Ceiling suspended

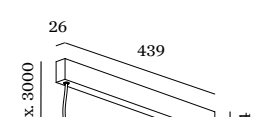

### D1 | CEILING DRIVER

220-240VAC | 50-60Hz | 48V incl. power middle/end feed adapter incl. DALI through wiring driver ceiling mounted

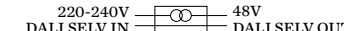

CODE

100W	90014368
100W	90014369
150W	90014372
150W	90014373



### D2 | IN LINE DRIVER

220-240VAC | 50-60Hz | 48V incl. power end feed adapter incl. DALI through wiring suspended driver in line with profile

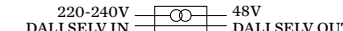

CODE

100W	90014360
100W	90014361
150W	90014362
150W	90014363

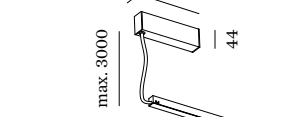

### D3 | IN TRACK DRIVER

220-240VAC | 50-60Hz | 48V incl. power end feed function incl. 3m power cable suspended driver in the profile

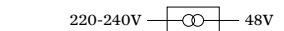

CODE

100W	90014157
100W	90014174

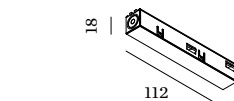

### P | POWER FEED

48V | 15A | DALI | end/middle power feed adapter | max. 4 x 1.5mm<sup>2</sup>

CODE

90014153
90014154

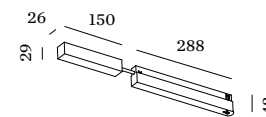

CODE

250W	90014179
250W	90014379
250W	90014377
250W	90014177

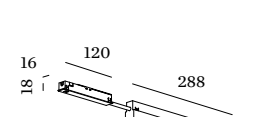

CODE

250W	90014146
250W	90014145

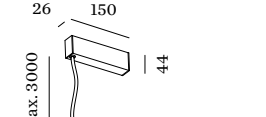

CODE

250W	90014158
250W	90014175

Ready to plan your **STREX?**



[weverducre.com/strex-configurator](http://weverducre.com/strex-configurator)

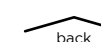

HOW TO CONTROL MY STREX SYSTEM

# What about *control and dim*

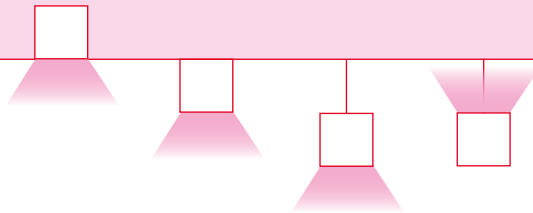

## All mountings

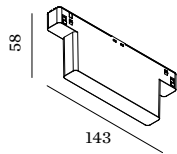

### WIRELESS CASAMBI CONTROL

8W | adapter for wireless control of 64 DALI fixtures in max. 8 groups

	CODE
	90014155
	90014156

The great thing about the STREX system? You have endless options. Do you just want to switch your lights on and off, or dim them? Then this can be done easily with DALI fixtures. If you don't want to install a hard-wired system, you can also opt for a more flexible version. All you need is a Casambi control module and suitable DALI insets.

Das Tolle am STREX-System? Man hat unendlich viele Möglichkeiten. Sie möchten Ihre Leuchten nur an- und ausschalten oder dimmen? Dann ist das mit DALI-Leuchten ganz easy möglich. Wer kein fest verkabeltes System installieren möchte, kann aber auch auf eine flexiblere Variante ausweichen. Was man dazu braucht? Ein Casambi-Kontrollmodul und passende DALI-Insets.



### Via Casambi app

To discover all features and functionalities of the app, visit the casambi website: [casambi.com](http://casambi.com) or download the app directly.

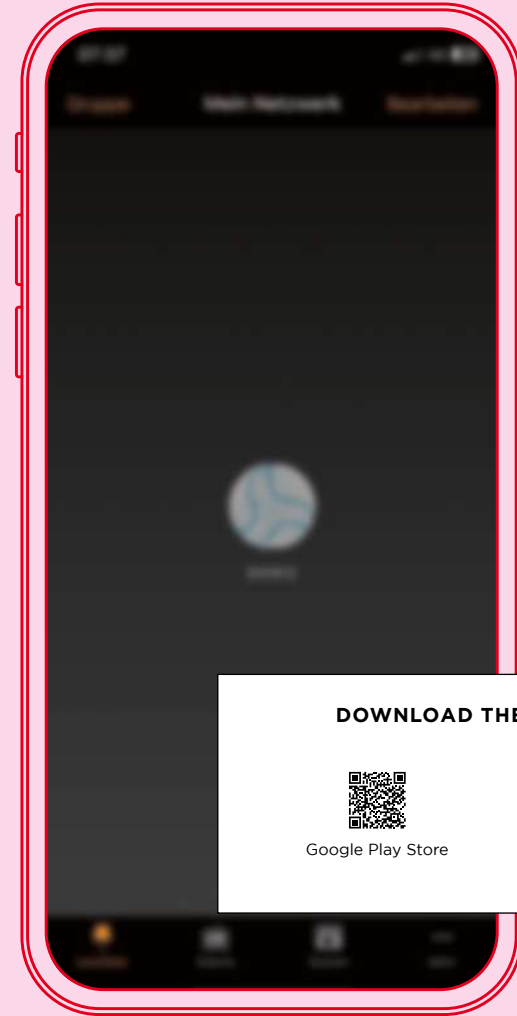

**DOWNLOAD THE CASAMBI APP**



Google Play Store



App Store

# Create a *scene* for your individual lighting solution.



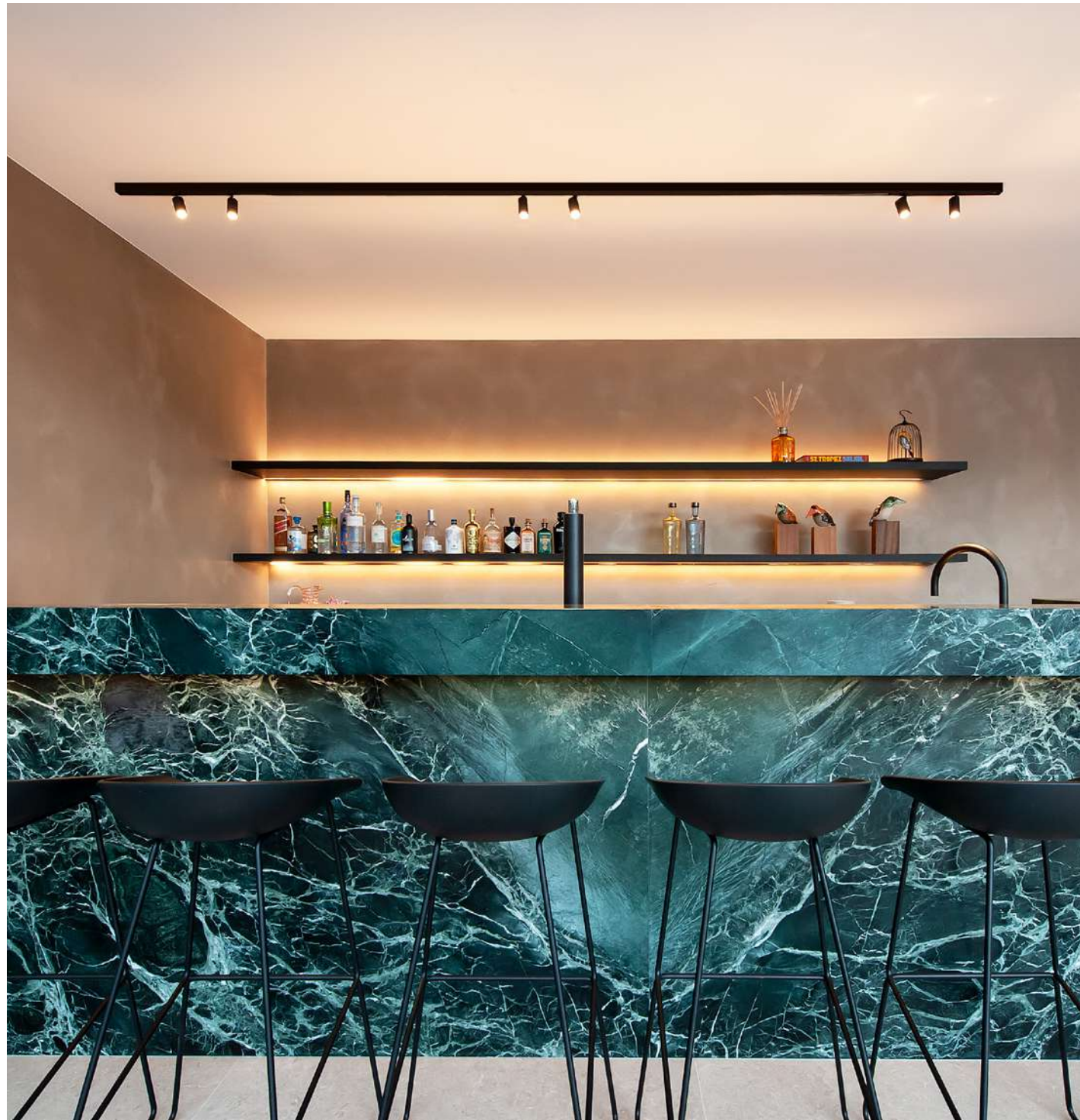

# CENO on STREX

48V system

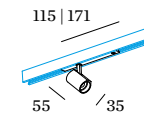

## 1.0

LED COB 7W | 48V  
aluminium | PC adapter

IP20 0-90°|355° A 31° SDCM2 L70|55K 0.11kg

non dim

	CODE
	166562W_
	166562BQ_
	166562K_
	166562CH_
	166562B_

DALI-2

	CODE
	166565W_
	166565BQ_
	166565K_
	166565CH_
	166565B_

LIGHT COLOUR	LUMEN CRI	CODE
2700K	470 >90	3
3000K	500 >90	5

accessories on page 821



### OPTIONAL

honeycomb louver

CODE
90051131

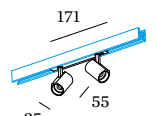

## 2.0

LED COB 13W | 48V  
aluminium | PC adapter

IP20 0-90°|355° A 31° SDCM2 L70|55K 0.19kg

non dim

	CODE
	166662W_
	166662BQ_
	166662K_
	166662CH_
	166662B_

DALI-2

	CODE
	166665W_
	166665BQ_
	166665K_
	166665CH_
	166665B_

LIGHT COLOUR	LUMEN CRI	CODE
2700K	2x470 >90	3
3000K	2x500 >90	5

accessories on page 821





# MATCH on STREX

48V system



reddot winner 2023



As awarded by The Chicago Athenaeum: Museum of Architecture and Design

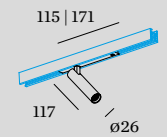

## 1.0

LED COB 7W | 48V  
aluminium | PC adapter

IP20 0-90°/360° 30° SDCM2 L80/50K 0.14kg

non dim

	CODE
	179152W_
	179152BL_
	179152CH_
	179152B_

DALI-2

	CODE
	179155W_
	179155BL_
	179155CH_
	179155B_

LIGHT COLOUR	LUMEN   CRI	CODE
2700K	535   >90	3
3000K	560   >90	5

accessories on page 821

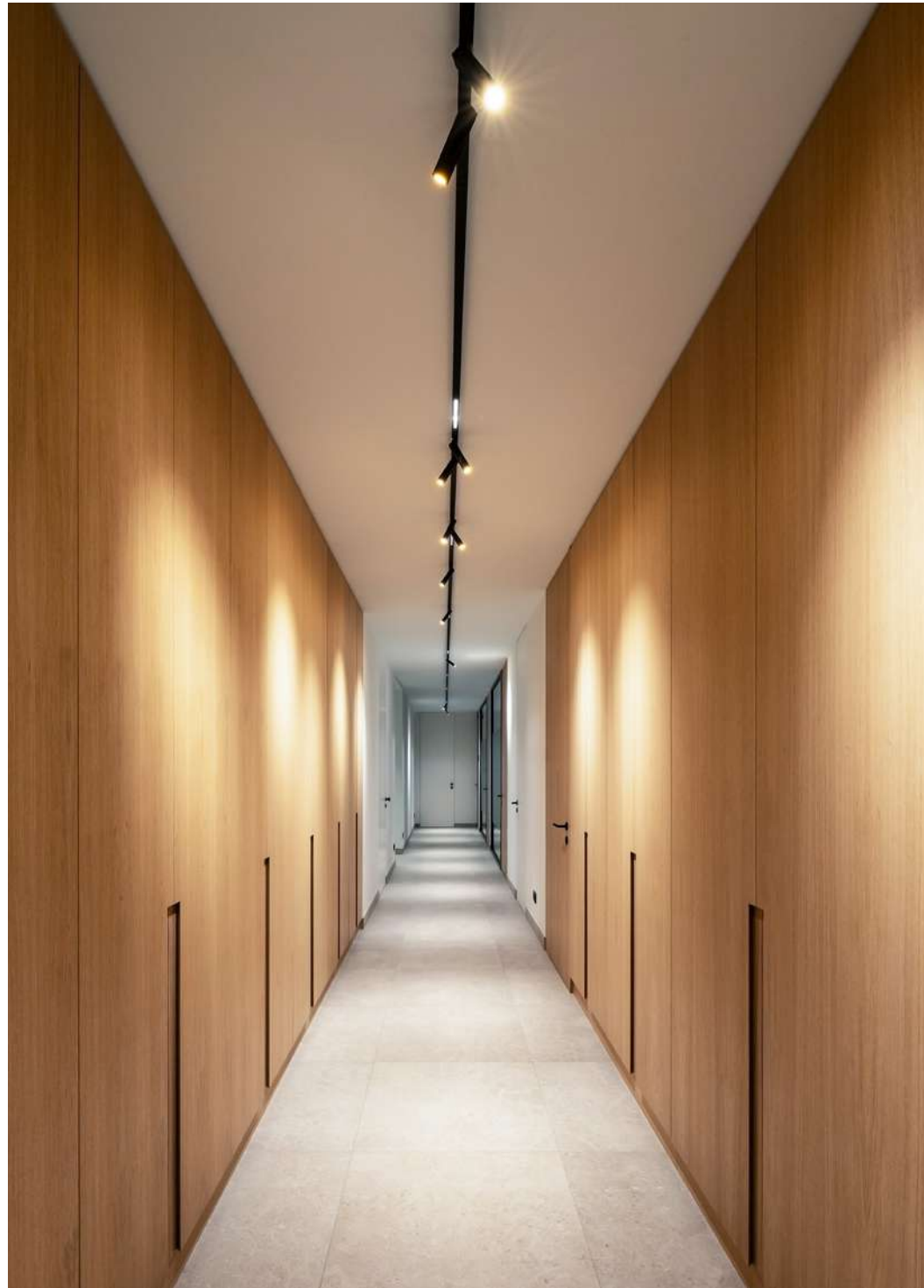

DENTAL PRACTICE M.K.A. | DMG ARCHITECTURAL SOLUTIONS KAPellen | BELGIUM

# MICK on STREX

48V system

reddot winner 2020  
lighting design

DESIGN AWARD 2021

**1.0**

LED COB10W | 48V  
aluminium | PC adapter

IP20 0-90°|360° 23° SDCM2 L80|50K 0.22kg

non dim

CODE
159442J_
159442K_

DALI-2

CODE
159445J_
159445K_

LIGHT COLOUR	LUMEN CRI	CODE
2700K	425 >90	3
3000K	465 >90	5

accessories on page 821

**2.0**

LED COB19W | 48V  
aluminium | PC adapter

IP20 0-90°|360° 23° SDCM2 L80|50K 0.44kg

non dim

CODE
159542J_
159542K_

DALI-2

CODE
159545J_
159545K_

LIGHT COLOUR	LUMEN CRI	CODE
2700K	2x425 >90	3
3000K	2x465 >90	5

accessories on page 821

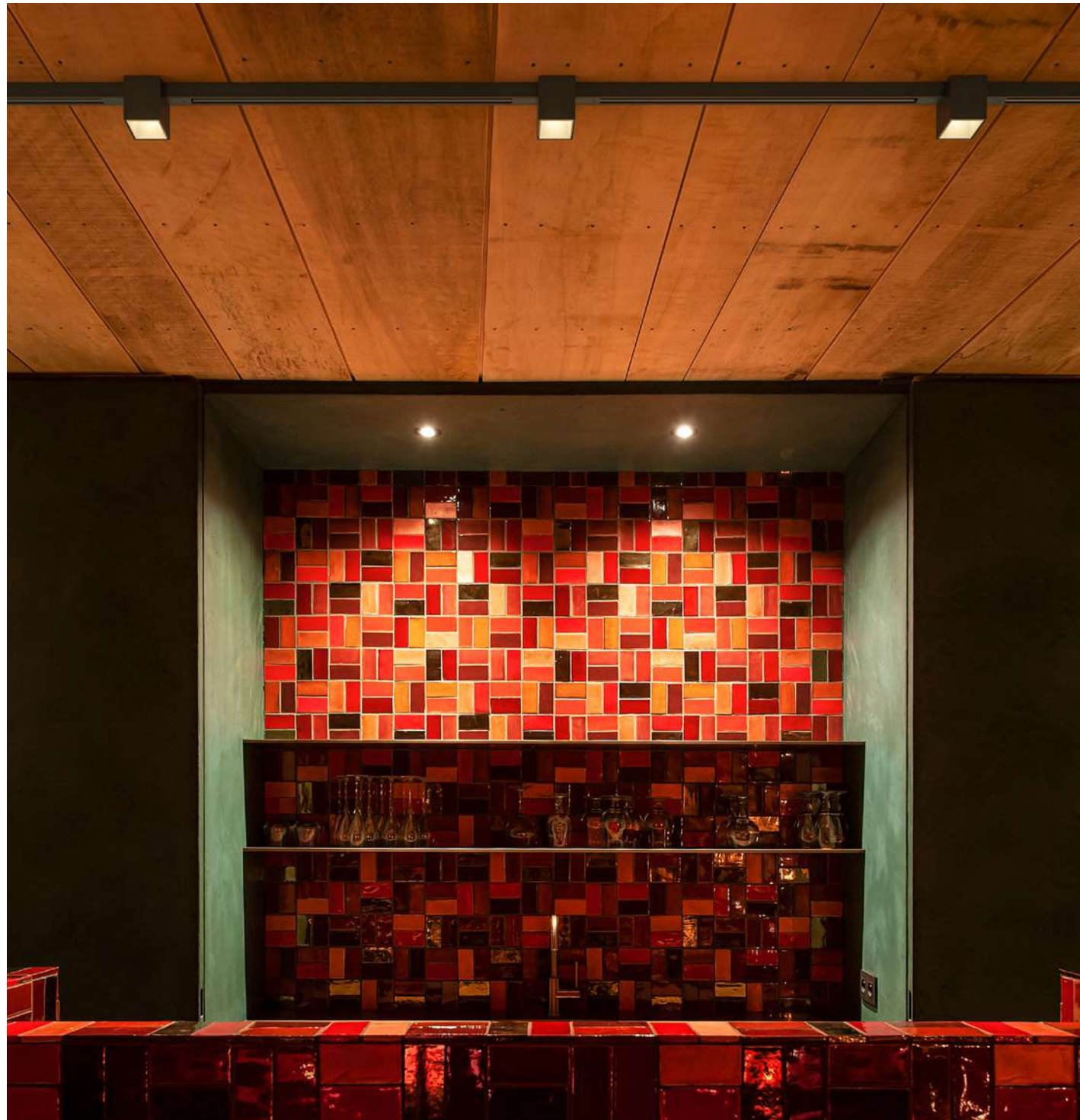

PRIVATE RESIDENCE BELGIUM



# BOX on STREX

48V system

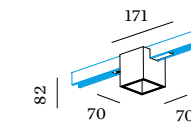

## 1.0

LED COB 7W | 48V  
aluminium

IP20  $\Delta$  25° SDCM2 L80/LSK 0.20kg

adapter | 2700K | CRI >90 | 440lm

	CODE
	258162W_3
	258162B_3
	DALI-2 258165W_3
	DALI-2 258165B_3

adapter | 3000K | CRI >90 | 470lm

	CODE
	258162W_5
	258162B_5
	DALI-2 258165W_5
	DALI-2 258165B_5

housing | inner reflector colour

	CODE
	W
	WM
	E
	M
	H
	Q
	BQ
	CH
	B

only for ceiling surface and suspended tracks

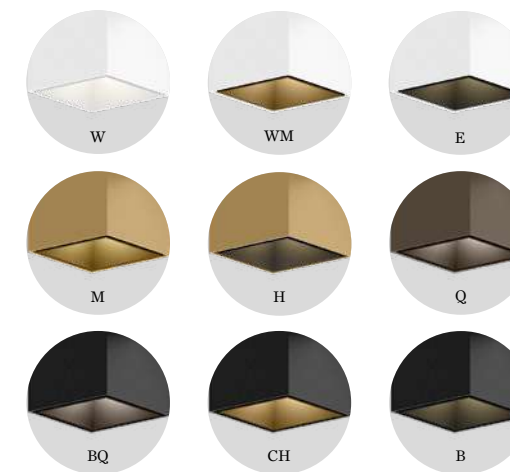

back



# DOCUS on STREX

48V system

82 | 70 | 70 | 171

**1.0**

LED COB 7W | 48V  
aluminium

IP20  $\angle$  25° SDCM2 L80I55K 0.18kg

adapter | 2700K | CRI >90 | 440lm

	CODE
	258362W_3
	258362B_3
	258365W_3
	258365B_3

adapter | 3000K | CRI >90 | 470lm

	CODE
	258362W_5
	258362B_5
	258365W_5
	258365B_5

housing | inner reflector colour

	CODE
	W
	J
	E
	BQ
	K
	B

only for ceiling surface and suspended tracks

[back](#)

WEVER & DUCRÉ 312 – 313



# HEXO on STREX

48V system

82 171 81

**1.0**

LED COB 7W | 48V  
aluminium

IP20  $\angle$  25° SDCM2 L80I55K 0.18kg

adapter | 2700K | CRI >90 | 440lm

	CODE
	258462W_3
	258462B_3
	DALI-2 258465W_3
	DALI-2 258465B_3

adapter | 3000K | CRI >90 | 470lm

	CODE
	258462W_5
	258462B_5
	DALI-2 258465W_5
	DALI-2 258465B_5

housing | inner reflector colour

	CODE
	W
	J
	E
	Q
	BQ
	K
	B

only for ceiling surface and suspended tracks

back

WEVER & DUCRÉ 314 – 315



# RAY on STREX

48V system

189

469

545

689

721

**1.0**

LED COB 7W | 48V  
aluminium

IP20  $\angle$  25° SDCM2 L80I55K 0.16kg

adapter | 2700K | CRI >90 | 440lm

	CODE
	258262W_3
	258262B_3
	DALI-2 258265W_3
	DALI-2 258265B_3

adapter | 3000K | CRI >90 | 470lm

	CODE
	258262W_5
	258262B_5
	DALI-2 258265W_5
	DALI-2 258265B_5

housing | inner reflector colour

	CODE
	W
	WM
	E
	M
	H
	Q
	BQ
	CH
	B

only for ceiling surface and suspended tracks

back

**WEVER & DUCRÉ** 316 – 317



# STREX MODULE

48V system

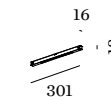

## 1.0 DOT

LED PCB 9W | 48V  
PC adapter | cover  
PC lens

IP20  $\Delta 24^\circ$  UGR=19 SDCM3 L80|60K 0.11kg

non dim

	CODE
	171342W_
	171342B_

DALI

	CODE
	171345W_
	171345B_

LIGHT COLOUR	LUMEN CRI	CODE
2700K	790 >90	3
3000K	880 >90	5

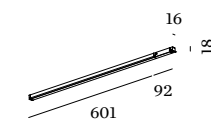

## 1.0 OPAL

LED PCB 12W | 48V  
PC adapter | cover  
PMMA opal cover

IP20 SDCM3 L80|60K 0.16kg

non dim

	CODE
	171382W_
	171382B_

DALI

	CODE
	171385W_
	171385B_

LIGHT COLOUR	LUMEN CRI	CODE
2700K	610 >90	3
3000K	630 >90	5

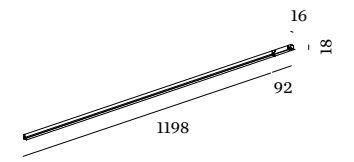

## 2.0 OPAL

LED PCB 24W | 48V  
PC adapter | cover  
PMMA opal cover

IP20 SDCM3 L80|60K 0.32kg

non dim

	CODE
	171482W_
	171482B_

DALI

	CODE
	171485W_
	171485B_

LIGHT COLOUR	LUMEN CRI	CODE
2700K	1225 >90	3
3000K	1265 >90	5

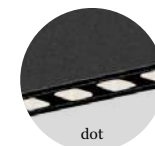

dot



opal



RESTAURANT PASSADIS DEL PEP | SILVIA FERNÁNDEZ BARCELONA | SPAIN

# MATCH on STREX

48V system



reddot winner 2023



DESIGN AWARD 2023



As awarded by The Chicago Athenaeum: Museum of Architecture and Design



57 | 113 | 145



223



407



515 | 623



659



3.0

LED COB 8W | 48V | DALI-2  
aluminium | PC adapter

IP20  $\Delta$  33° SDCM2 L80I50K 0.18kg

CODE	
	179265W_
	179265L_
	179265M_
	179265B_

LIGHT COLOUR	LUMEN CRI	CODE
2700K	490 >90	3
3000K	520 >90	5

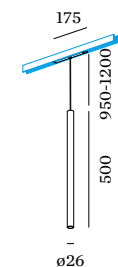

5.0

LED COB 8W | 48V | DALI-2  
aluminium | PC adapter

IP20  $\Delta$  33° SDCM2 L80I50K 0.23kg

CODE	
	179365W_
	179365L_
	179365M_
	179365B_

LIGHT COLOUR	LUMEN CRI	CODE
2700K	490 >90	3
3000K	520 >90	5



OTHER LENGTHS ONLINE  
weverducre.com/more-match-on-strex

white fixture with white cable/adaptor  
other fixtures with black cable/adaptor  
more colour combinations on request

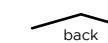

back



# ODREY on STREX

48V system

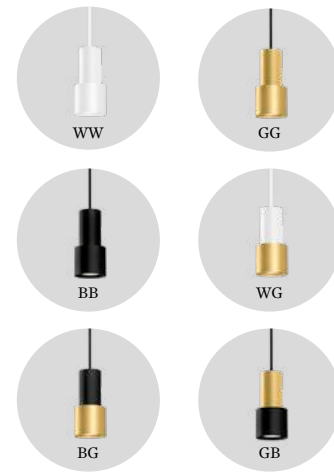

## 1.1

LED COB 7W | 48V | DALI-2  
aluminium | PC adapter

IP20 32° SDCM2 L70|55K 0.28kg

CODE
187165WW_
187165GG_
187165BB_
187165WG_
187165BG_
187165GB_

white fixture with white cable/adapter  
other fixtures with black cable/adapter  
more colour combinations on request

LIGHT COLOUR	LUMEN CRI	CODE
2700K	400 >90	3
3000K	445 >90	5

## 1.2

LED COB 7W | 48V | DALI-2  
aluminium | shade matching  
inner cover included | PC adapter

IP20 32° SDCM2 L70|55K 0.48kg

CODE
187265WW_
187265GG_
187265BB_
187265WG_
187265BG_
187265GB_

LIGHT COLOUR	LUMEN CRI	CODE
2700K	400 >90	3
3000K	445 >90	5

## 1.3

LED COB 7W | 48V | DALI-2  
aluminium | PC adapter

IP20 32° SDCM2 L70|55K 0.27kg

CODE
187365WW_
187365GG_
187365BB_
187365WG_
187365BG_
187365GB_

LIGHT COLOUR	LUMEN CRI	CODE
2700K	450 >90	3
3000K	470 >90	5

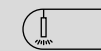
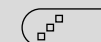

461



525

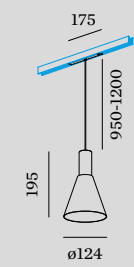

### 1.4

LED COB 7W | 48V | DALI-2  
aluminium | PC adapter

IP20 32° SDCM2 L70|55K 0.32kg



CODE
187465WW_
187465GG_
187465BB_
187465WG_
187465BG_
187465GB_

LIGHT COLOUR	LUMEN	CRI	CODE
2700K	450	>90	3
3000K	470	>90	5

white fixture with white cable/adapter  
other fixtures with black cable/adapter  
more colour combinations on request

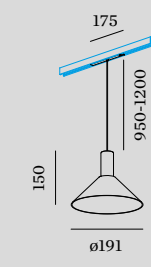

### 1.6

LED COB 7W | 48V | DALI-2  
aluminium | PC adapter

IP20 32° SDCM2 L70|55K 0.70kg

CODE
187665WW_
187665GG_
187665BB_
187665WG_
187665BG_
187665GB_

LIGHT COLOUR	LUMEN	CRI	CODE
2700K	480	>90	3
3000K	505	>90	5

optional inner cover on page 816

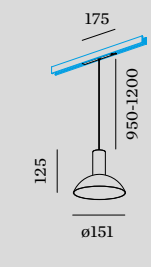

### 1.7

LED COB 7W | 48V | DALI-2  
aluminium | PC adapter

IP20 32° SDCM2 L70|55K 0.34kg

CODE
187765WW_
187765GG_
187765BB_
187765WG_
187765BG_
187765GB_

LIGHT COLOUR	LUMEN	CRI	CODE
2700K	480	>90	3
3000K	505	>90	5

optional inner cover on page 816





# SOLLI on STREX

48V system

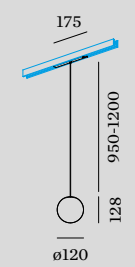
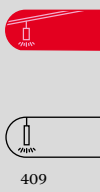

1.0

LED COB 5W | 48V | DALI-2  
aluminium | black cable  
artisanal Italian hand blown glass  
PC adapter

IP20 SDCM2 L80|50K 0.55kg

	CODE
	238185FD_
	238185TD_
	238185WB_

other cable lengths on request

LIGHT COLOUR	LUMEN CRI	CODE
2700K	280 >90	3
3000K	290 >90	5

back

# 1-PHASE TRACKS

220-240V tracks / accessories

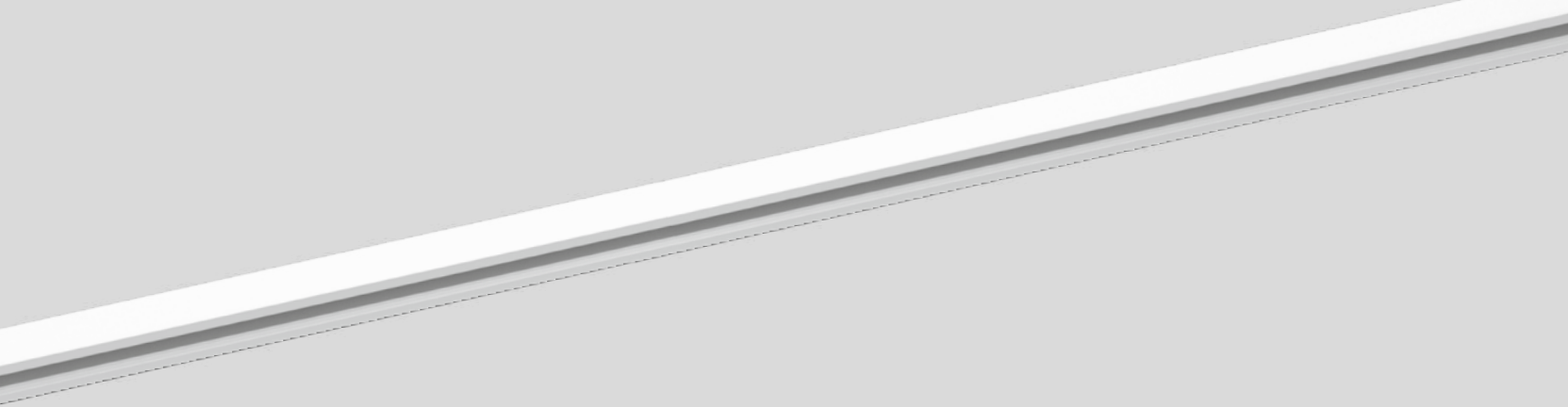

## RECESSED | SURFACE | SUSPENDED EXAMPLES

configuration as seen from top view

for more support and extended layout of 1-phase tracks, please check our FAQ section on [weverducre.com/faq](http://weverducre.com/faq)

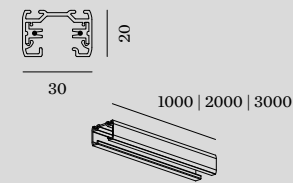
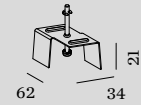
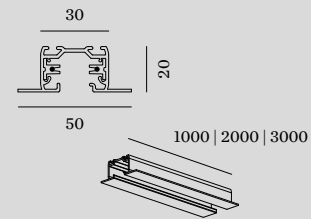
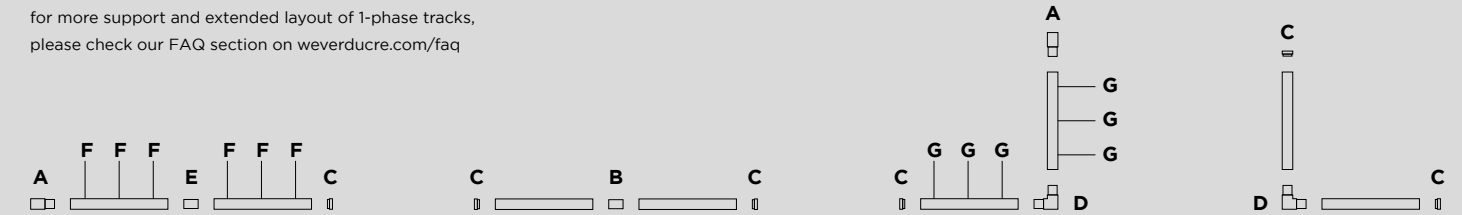

### TRACK PROFILE

recessed | 220-240V | 16A



	CODE
1m	90014118
1m	90014119
2m	90014120
2m	90014121
3m	90014122
3m	90014123

### F | MOUNTING BRACKET

for recessed fixation



	CODE
	90014100
for 1.0m - 2pcs needed for 2.0m - 3pcs needed for 3.0m - 4pcs needed	

### TRACK PROFILE

surface | suspended | 220-240V | 16A



	CODE
1m	90014001
1m	90014007
2m	90014002
2m	90014008
3m	90014003
3m	90014009

### G | SUSPENSION SET

complete suspension set  
incl. ceiling fixation bracket

	CODE
max. 1.5m	90014101
max. 1.5m	90014102
max. 3m	90014103
max. 3m	90014104
for 1.0m - 2pcs needed for 2.0m - 3pcs needed for 3.0m - 4pcs needed	

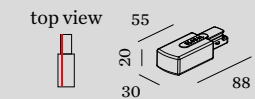

### A | END FEED 1.0

220-240V | max. 3 x 1.5mm<sup>2</sup> - 16A

	CODE
	90014018
	90014019

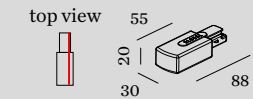

### A | END FEED 2.0

220-240V | max. 3 x 1.5mm<sup>2</sup> - 16A

	CODE
	90014020
	90014021

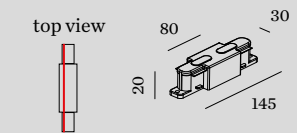

### B | MIDDLE FEED

straight  
220-240V | max. 3 x 1.5mm<sup>2</sup> - 16A

	CODE
	90014036
	90014037

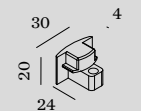

### C | END CAP LEFT/RIGHT

	CODE
	90014028
	90014029



### D | L-FEED 1.0

220-240V | max. 3 x 1.5mm<sup>2</sup> - 16A

	CODE
	90014024
	90014025



### D | L-FEED 2.0

220-240V | max. 3 x 1.5mm<sup>2</sup> - 16A

	CODE
	90014026
	90014027



### E | STRAIGHT CONNECTOR

straight | 220-240V | 16A

	CODE
	90014022
	90014023

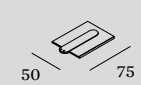

### COVERPLATE END FEED

only use with recessed tracks

	CODE
	90014124
	90014125

more 1-phase track accessories on page 822



# SARA on track

1-Phase

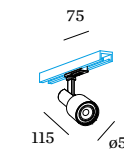
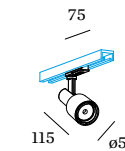

## 1.0 LED

LED COB 8W | phase-cut dim  
220-240VAC | 50-60Hz  
aluminium  
1-phase Global® track adapter

IP20 0-90°/355° 34° SDCM3 L70|55K 0.24kg

## 1.0 PAR16

PAR16 max. 12W | GU10  
100-240VAC | 50-60Hz  
aluminium  
1-phase Global® track adapter

IP20 0-90°/355° 0.16kg

	CODE
	157168W_
	157168G_
	157168K_
	157168B_

LIGHT COLOUR	LUMEN CRI	CODE
2700K	655 >80	3
3000K	700 >80	5

	CODE
	157120W0
	157120G0
	157120K0
	157120B0

## OPTIONAL

	CODE
2700K   460lm	901228W3
2700K   437lm	901228B3
3000K   500lm	901228W5
3000K   457lm	901228B5





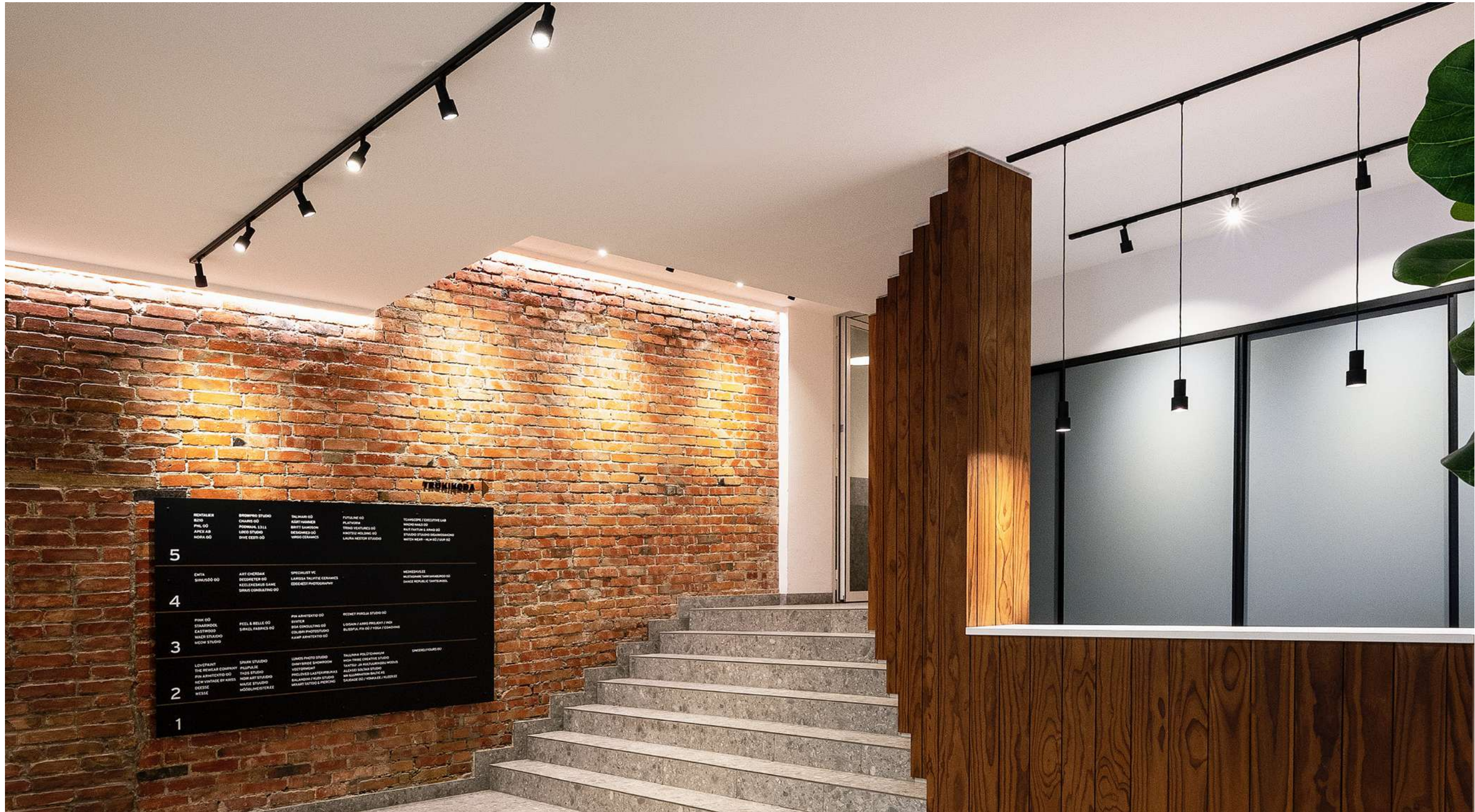



# SQUBE on track

1-Phase



243

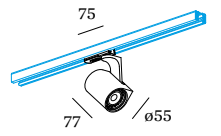
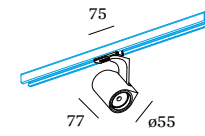

## 1.0 LED

LED COB 6W | phase-cut dim  
220-240VAC | 50-60Hz  
aluminium  
1-phase Global® track adapter

IP20 0-90°/355° 39° SDCM3 L70/55K 0.36kg

	CODE
	144168W_
	144168B_

LIGHT COLOUR	LUMEN CRI	CODE
2700K	415 >90	3
3000K	430 >90	5
1800-3000K	350 >90	9



black ring  
LED



PAR16





## 1.0 PAR16

PAR16 max. 12W | GU10  
100-240VAC | 50-60Hz  
aluminium  
1-phase Global® track adapter

IP20 0-90°/355° 0.32kg

	CODE
	144120W0
	144120B0

## OPTIONAL

PAR16 6.5W   GU10   phase-cut dim		CODE
	2700K   460lm	901228W3
	2700K   437lm	901228B3
	3000K   500lm	901228W5
	3000K   457lm	901228B5



# PIRRO on track

1-Phase

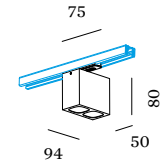
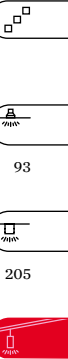

## 2.0 SPOT

LED COB 11W | phase-cut dim  
220-240VAC | 50-60Hz | incl. driver  
aluminium | PC lens and reflector  
1-phase Global® track adapter

IP20 310° 32° SDCM2 L70|55K 0.36kg

CODE		
	173264E_	
	173264K_	
	173264B_	

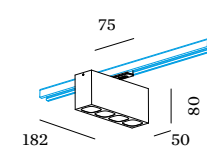

LIGHT COLOUR	LUMEN CRI	CODE
2700K	2x360 >90	3
3000K	2x380 >90	5



## 4.0 SPOT

LED COB 20W | phase-cut dim  
220-240VAC | 50-60Hz | incl. driver  
aluminium | PC lens and reflector  
1-phase Global® track adapter

IP20 310° 32° SDCM2 L70|55K 0.58kg

CODE		
	173464E_	
	173464K_	
	173464B_	

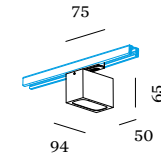

LIGHT COLOUR	LUMEN CRI	CODE
2700K	4x360 >90	3
3000K	4x380 >90	5



## 2.0 OPAL

LED PCB 7W | phase-cut dim  
220-240VAC | 50-60Hz | incl. driver  
aluminium | PMMA cover  
1-phase Global® track adapter

IP20 310° SDCM3 L80|60K 0.33kg

CODE		
	173284E_	
	173284K_	
	173284B_	

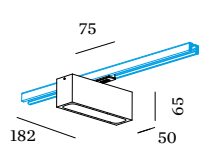

LIGHT COLOUR	LUMEN CRI	CODE
2700K	270 >90	3
3000K	290 >90	5



## 4.0 OPAL

LED PCB 12W | phase-cut dim  
220-240VAC | 50-60Hz | incl. driver  
aluminium | PMMA cover  
1-phase Global® track adapter

IP20 310° SDCM3 L80|60K 0.54kg

CODE		
	173484E_	
	173484K_	
	173484B_	

LIGHT COLOUR	LUMEN CRI	CODE
2700K	710 >90	3
3000K	740 >90	5

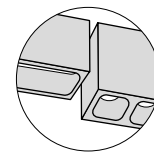

white fixtures with white adapter  
other fixtures with black adapter

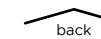



# DRO on track

1-Phase

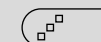

263



413



557



647 | 661

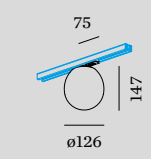

## 1.0

QT14 max. 5W | G9  
220-240VAC | 50-60Hz  
aluminium  
artisanal Italian hand blown glass  
1-phase Global® track adapter

⊕ IP20 0.60kg

CODE

1724G0WB0

## OPTIONAL

QT14 3W | G9 | phase-cut dim | clear

CODE

2700K | 300lm 9010G802

3000K | 280lm 9010G804

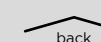

back



# RAY | HEXO on track

1-Phase

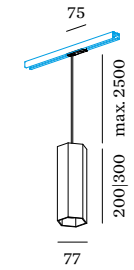

## HEXO 2.0 | 3.0

PAR16 max. 12W | GU10  
100-240VAC | 50-60Hz  
aluminium  
1-phase Global® track adapter

⊕ IP20 0.58 | 0.74kg

2.0 200mm	CODE
	215520G0
	215520Q0
	215520P0
	215520B0

3.0 300mm	CODE
	215620G0
	215620Q0
	215620P0
	215620B0

### OPTIONAL

PAR16 6.5W   GU10   phase-cut dim	CODE
2700K   460lm	901228W3
2700K   437lm	901228B3
3000K   500lm	901228W5
3000K   457lm	901228B5

white fixture with white cable/adapter  
other fixtures with black cable/adapter  
more colour combinations on request

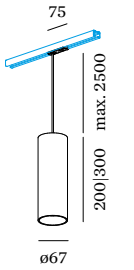

## RAY 2.0 | 3.0

PAR16 max. 12W | GU10  
100-240VAC | 50-60Hz  
aluminium  
1-phase Global® track adapter

⊕ IP20 0.54 | 0.68kg

2.0 200mm	CODE
	217520W0
	217520G0
	217520M0
	217520P0
	217520B0

3.0 300mm	CODE
	217620W0
	217620G0
	217620M0
	217620P0
	217620B0

### OPTIONAL

PAR16 6.5W   GU10   phase-cut dim	CODE
2700K   460lm	901228W3
2700K   437lm	901228B3
3000K   500lm	901228W5
3000K   457lm	901228B5

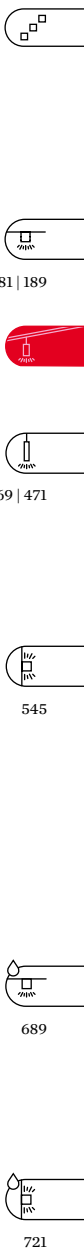

# ODREY on track

1-Phase

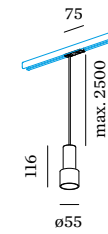





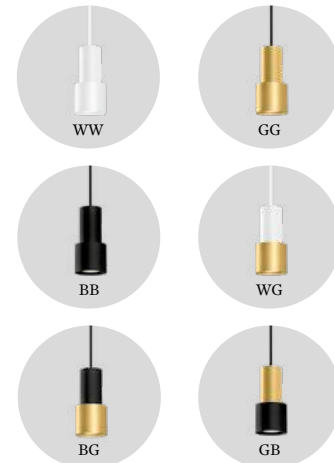

### 1.1

PAR16 max. 12W | GU10  
100-240VAC | 50-60Hz  
aluminium  
incl. 1-phase Global® track adapter





⊕ IP20 0.29kg



	CODE
	187120WW0
	187120GG0
	187120BB0
	187120WG0
	187120BG0
	187120GB0

### OPTIONAL

PAR16 6.5W | GU10 | phase-cut dim

	CODE
	2700K   460lm 901228W3
	2700K   437lm 901228B3
	3000K   500lm 901228W5
	3000K   457lm 901228B5



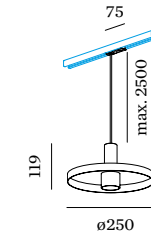



white fixture with white cable/adapter  
other fixtures with black cable/adapter  
more colour combinations on request



### 1.2





PAR16 max. 12W | GU10  
100-240VAC | 50-60Hz  
aluminium | shade matching  
inner cover included  
incl. 1-phase Global® track adapter

⊕ IP20 0.49kg

	CODE
	187220WW0
	187220GG0
	187220BB0
	187220WG0
	187220BG0
	187220GB0

### OPTIONAL

PAR16 6.5W | GU10 | phase-cut dim



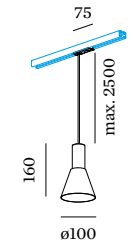



	CODE
	2700K   460lm 901228W3
	2700K   437lm 901228B3
	3000K   500lm 901228W5
	3000K   457lm 901228B5



### 1.3





PAR16 max. 12W | GU10  
100-240VAC | 50-60Hz  
aluminium  
incl. 1-phase Global® track adapter

⊕ IP20 0.28kg

	CODE
	187320WW0
	187320GG0
	187320BB0
	187320WG0
	187320BG0
	187320GB0

### OPTIONAL

PAR16 6.5W | GU10 | phase-cut dim

	CODE
	2700K   460lm 901228W3
	2700K   437lm 901228B3
	3000K   500lm 901228W5
	3000K   457lm 901228B5

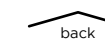

back

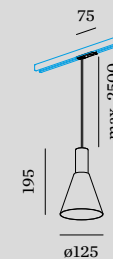

### 1.4

PAR16 max. 12W | GU10  
100-240VAC | 50-60Hz  
aluminium  
incl. 1-phase Global® track adapter

⊕ IP20 0.33kg



white fixture with white cable/adapter  
other fixtures with black cable/adapter  
more colour combinations on request

	CODE
	187420WW0
	187420GG0
	187420BB0
	187420WG0
	187420BG0
	187420GB0

### OPTIONAL

PAR16 6.5W | GU10 | phase-cut dim

	CODE
	2700K   460lm 901228W3
	2700K   437lm 901228B3
	3000K   500lm 901228W5
	3000K   457lm 901228B5

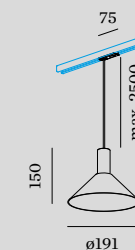

### 1.6

PAR16 max. 12W | GU10  
100-240VAC | 50-60Hz  
aluminium  
incl. 1-phase Global® track adapter

⊕ IP20 0.36kg

	CODE
	187620WW0
	187620GG0
	187620BB0
	187620WG0
	187620BG0
	187620GB0

optional inner cover on page 755

### OPTIONAL

PAR16 6.5W | GU10 | phase-cut dim

	CODE
	2700K   460lm 901228W3
	2700K   437lm 901228B3
	3000K   500lm 901228W5
	3000K   457lm 901228B5

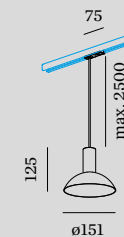

### 1.7

PAR16 max. 12W | GU10  
100-240VAC | 50-60Hz  
aluminium  
incl. 1-phase Global® track adapter

⊕ IP20 0.32kg

	CODE
	187720WW0
	187720GG0
	187720BB0
	187720WG0
	187720BG0
	187720GB0

optional inner cover on page 755

### OPTIONAL

PAR16 6.5W | GU10 | phase-cut dim

	CODE
	2700K   460lm 901228W3
	2700K   437lm 901228B3
	3000K   500lm 901228W5
	3000K   457lm 901228B5

# 3-PHASE TRACKS

220-240V tracks | accessories

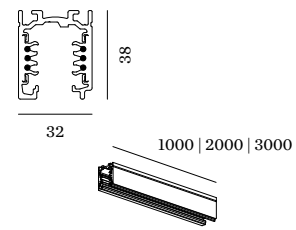

## TRACK PROFILE

surface | suspended | DALI  
220-240V | 16A

⊕ DALI FELV

	CODE
1m	90014200
1m	90014201
2m	90014202
2m	90014203
3m	90014204
3m	90014205

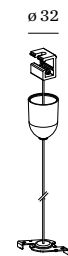

## F | SUSPENSION SET

complete suspension set  
incl. ceiling fixation bracket

	CODE
max. 1.5m	90014206
max. 1.5m	90014207
max. 3m	90014208
max. 3m	90014209

for 1.0m - 2pcs needed  
for 2.0m - 3pcs needed  
for 3.0m - 4pcs needed

## SURFACE | SUSPENDED EXAMPLES

configuration as seen from top view

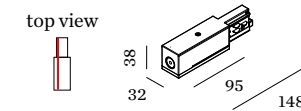
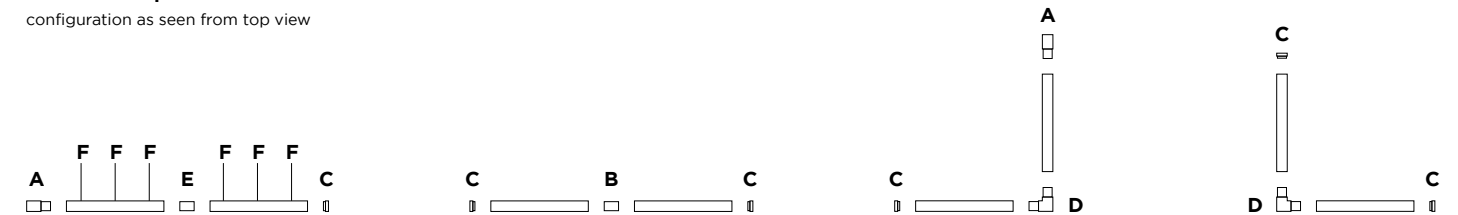

## A | END FEED 1.0

including cable gasket  
220-240V | max. 7 x 1.5-2.5mm<sup>2</sup> | 16A

	CODE
	90014240
	90014241

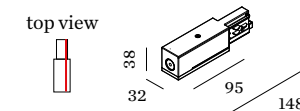

## A | END FEED 2.0

including cable gasket  
220-240V | max. 7 x 1.5-2.5mm<sup>2</sup> | 16A

	CODE
	90014238
	90014239

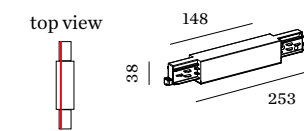

## B | MIDDLE FEED

straight  
220-240V | max. 7 x 1.5-2.5mm<sup>2</sup> | 16A

	CODE
	90014224
	90014225

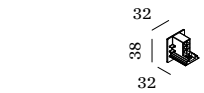

## C | END CAP LEFT/RIGHT

	CODE
	90014216
	90014217

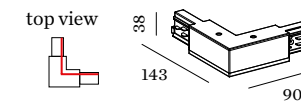

## D | L-FEED 1.0

220-240V | max. 7 x 1.5-2.5mm<sup>2</sup> | 16A

	CODE
	90014220
	90014221

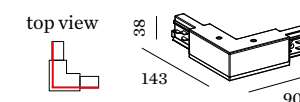

## D | L-FEED 2.0

220-240V | max. 7 x 1.5-2.5mm<sup>2</sup> | 16A

	CODE
	90014222
	90014223

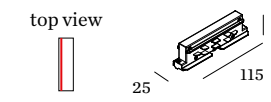

## E | STRAIGHT CONNECTOR

straight | 220-240V | 16A

	CODE
	90014226
	90014227

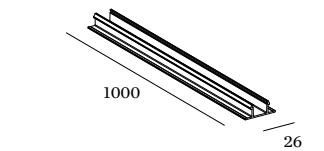

## TRACK COVER

	CODE
1m	90014236
1m	90014237

more 3-phase track accessories on  
page 823

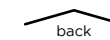

back





# SQUBE on track

3-Phase

**1.0 PAR16**

PAR16 max. 12W | GU10  
100-240VAC | 50-60Hz  
aluminium  
3-phase track adapter

⊕ IP20 0-90°|355° 0.32kg

CODE
144720W0
144720B0

**OPTIONAL**

PAR16 6.5W | GU10 | phase-cut dim

CODE
2700K   460lm 901228W3
2700K   437lm 901228B3
3000K   500lm 901228W5
3000K   457lm 901228B5

**2.0 LED**

LED LED COB 12W | phase-cut dim  
220-240VAC | 50-60Hz  
aluminium  
3-phase track adapter

⊕ IP20 0-90°|355° ∠32° SDCM3 L70|55K 0.40kg

CODE
144368W_
144368B_

LIGHT COLOUR	LUMEN CRI	CODE
2700K	940 >90	3
3000K	970 >90	5
1800K-3000K	640 >90	9

**3.0 LED**

LED LED COB 15W | phase-cut dim  
220-240VAC | 50-60Hz  
aluminium  
3-phase track adapter

⊕ IP20 0-90°|355° ∠27° SDCM3 L70|55K 0.75kg

CODE
144558W_
144558B_

LIGHT COLOUR	LUMEN CRI	CODE
2700K	1400 >90	3
3000K	1480 >90	5

black ring  
LED

PAR16



# CENO fort on track

3-Phase



119



227



513

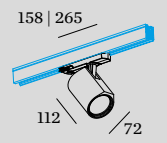
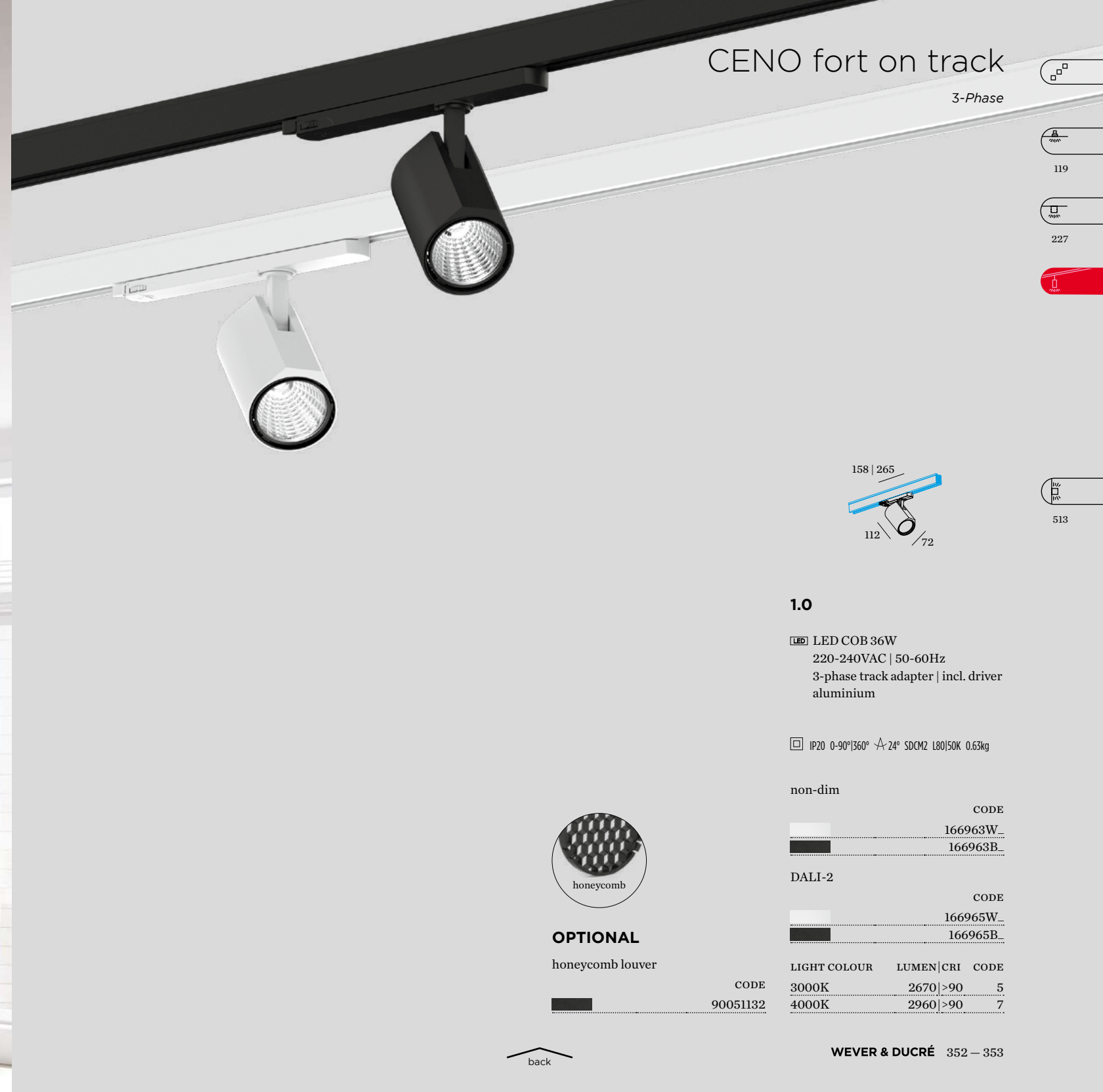

## 1.0

**LED** LED COB 36W  
 220-240VAC | 50-60Hz  
 3-phase track adapter | incl. driver  
 aluminium

**IP** IP20 0-90°/360° **A** 24° SDCM2 L80/50K 0.63kg

non-dim

	CODE
	166963W_
	166963B_

DALI-2

	CODE
	166965W_
	166965B_

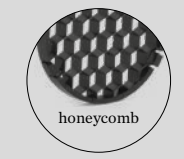

OPTIONAL  
 honeycomb louver

CODE	LIGHT COLOUR	LUMEN CRI	CODE
	3000K	2670 >90	5
	4000K	2960 >90	7

back



# RAY | HEXO on track

3-Phase

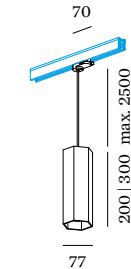

## HEXO 2.0 | 3.0

PAR16 max. 12W | GU10  
100-240VAC | 50-60Hz  
aluminium  
3-phase track adapter

⊕ IP20 0.58 | 0.74kg

**2.0**

200mm

CODE

	215320G0
	215320Q0
	215320P0
	215320B0

**3.0**

300mm

CODE

	215420G0
	215420Q0
	215420P0
	215420B0

## OPTIONAL

PAR16 6.5W | GU10 | phase-cut dim

CODE

	2700K   460lm	901228W3
	2700K   437lm	901228B3
	3000K   500lm	901228W5
	3000K   457lm	901228B5

white fixture with white cable/adaptor  
other fixtures with black cable/adaptor  
more colour combinations on request

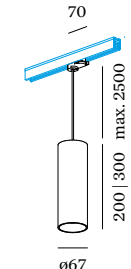

## RAY 2.0 | 3.0

PAR16 max. 12W | GU10  
100-240VAC | 50-60Hz  
aluminium  
3-phase track adapter

⊕ IP20 0.54 | 0.68kg

**2.0**

200mm

CODE

	217320W0
	217320G0
	217320M0
	217320P0
	217320B0

**3.0**

300mm

CODE

	217420W0
	217420G0
	217420M0
	217420P0
	217420B0

## OPTIONAL

PAR16 6.5W | GU10 | phase-cut dim

CODE

	2700K   460lm	901228W3
	2700K   437lm	901228B3
	3000K   500lm	901228W5
	3000K   457lm	901228B5



# ROOMOR OFFICE on track

3-Phase



reddot winner 2021



As awarded by The Chicago Athenaeum: Museum of Architecture and Design

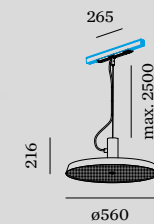

## 1.0 MICROPRISMATIC

LED LED PCB 35W | DALI-2  
220-240VAC | 50-60Hz  
aluminium  
microprismatic PMMA cover  
3-phase track adapter incl. driver

IP20 SDCM3 L80|60K UGR ≤ 19 4.43kg

3000K | CRI >90 | 3660lm

CODE

1684M5W5

1684M5B5

4000K | CRI >90 | 3660lm

CODE

1684M5W7

1684M5B7

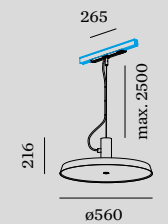
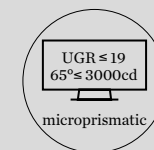

## 1.0 OPAL

LED LED PCB 35W | DALI-2  
220-240VAC | 50-60Hz  
aluminium | opal PMMA cover  
3-phase track adapter incl. driver

IP20 SDCM3 L80|60K 4.43kg

3000K | CRI >90 | 3700lm

CODE

168485W5

168485B5

4000K | CRI >90 | 3700lm

CODE

168485W7

168485B7



# How to combine your *PIRRO system.*

**CEILING BASE SURFACE**  
available in ○ white, ● gold or ● black

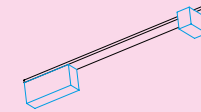

1.0  
754 mm

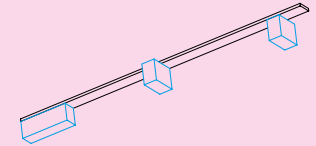

2.0  
1150 mm



**PIRRO OPAL OR SPOT INSETS**  
available in ● white and black, ● white and gold, ● black and gold or ● black



2.0  
opal



2.0  
spot



4.0  
opal



4.0  
spot

**CREATE YOUR OWN DESIGN**  
some examples

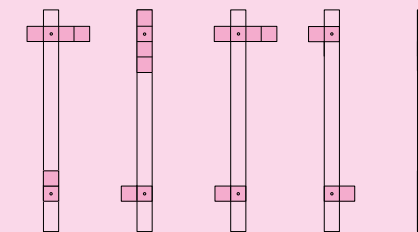

ceiling base 1.0 with insets  
754 mm

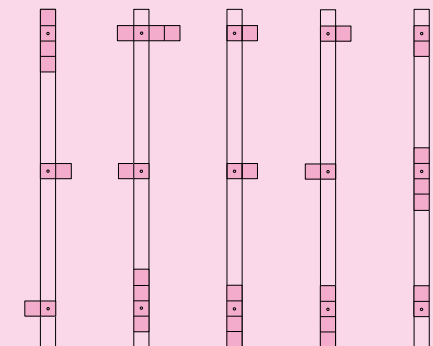

ceiling base 2.0 with insets  
1150 mm

## SPOT LANDING FOR YOUR FAVOURITE LIGHT

# Yep, *right there*

There's certainly one question you no longer need to ask: Where is the power outlet? That's because this doesn't really matter with PIRRO SYSTEM. After all, lights can be optically positioned precisely where they look just right – perfect, in fact. How does it work? PIRRO opal and PIRRO spot insets can be attached to two rails of different lengths and in many different versions. This lets you create a small work of art on every ceiling reminiscent of well-known Bauhaus classics – and that's no coincidence. Serge Cornelissen used exactly those classics as models for his lamp creation, which above all sets itself apart with its functionality, style, and minimalism. A true success story, if we do say so ourselves. We'd like to add that the PIRRO SYSTEM is available in subtle white, gold, or black, and can be combined with insets in two sizes and four different colours.

Eine Frage müssen Sie sich ab sofort bestimmt nicht mehr stellen und zwar: Wo ist hier der Stromauslass? Denn das ist mit PIRRO SYSTEM ziemlich egal. Schließlich lassen sich Leuchten damit optisch punktgenau dort platzieren, wo sie einfach richtig und zwar richtig gut aussehen. Wie's funktioniert? PIRRO Opal und PIRRO Spot Insets können auf zwei unterschiedlich langen Schienen und in vielen verschiedenen Varianten angebracht werden. So entsteht an jeder Decke ein kleines Kunstwerk, das nicht umsonst an jeder Decke ein kleines Kunstwerk, das nicht umsonst an bekannte Bauhaus-Klassiker denken lässt. Genau die dienten Serge Cornelissen nämlich als Vorbild für seine Leuchtenkreation, die vor allem durch Funktionalität, Stil und Minimalismus besticht. Echt gelungen, finden wir und fügen hinzu, dass PIRRO SYSTEM in dezentem Weiß, Gold oder Schwarz zu haben ist und mit Insets in zwei Größen und vier verschiedenen Farbvarianten kombiniert werden kann.

# PIRRO SYSTEM

Ceiling surface

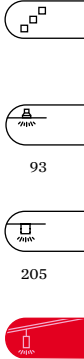

## CHOOSE YOUR BASE

**1.0 ceiling base**  
ceiling base for 2 insets  
aluminium

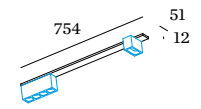

COLOR	CODE
White	90052072
Gold	90052074
Black	90052073

**2.0 ceiling base**  
ceiling base for 3 insets  
aluminium

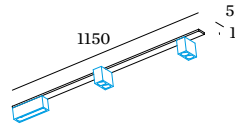

COLOR	CODE
White	90052075
Gold	90052077
Black	90052076

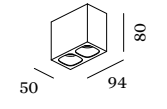

**2.0 SPOT**  
LED COB 11W | phase-cut dim  
220-240VAC | 50-60Hz | incl. driver  
aluminium | PC lens and reflector

⊕ IP20  $\Delta$  32° SDCM2 L70I55K 0.30kg

COLOR	CODE
White	151264E_
Gold	151264J_
Black	151264K_
Black	151264B_

LIGHT COLOUR	LUMEN CRI	CODE
2700K	2x360 >90	3
3000K	2x380 >90	5

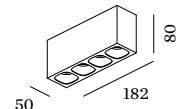

**4.0 SPOT**  
LED COB 20W | phase-cut dim  
220-240VAC | 50-60Hz | incl. driver  
aluminium | PC lens and reflector

⊕ IP20  $\Delta$  32° SDCM2 L70I55K 0.48kg

COLOR	CODE
White	151464E_
Gold	151464J_
Black	151464K_
Black	151464B_

LIGHT COLOUR	LUMEN CRI	CODE
2700K	4x360 >90	3
3000K	4x380 >90	5

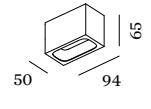

**2.0 OPAL**  
LED PCB 7W | phase-cut dim  
220-240VAC | 50-60Hz | incl. driver  
aluminium | opal PMMA cover

⊕ IP20 SDCM3 L80I60K 0.30kg

COLOR	CODE
White	151284E_
Gold	151284J_
Black	151284K_
Black	151284B_

LIGHT COLOUR	LUMEN CRI	CODE
2700K	240 >90	3
3000K	260 >90	5

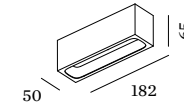

**4.0 OPAL**  
LED PCB 12W | phase-cut dim  
220-240VAC | 50-60Hz | incl. driver  
aluminium | opal PMMA cover

⊕ IP20 SDCM3 L80I60K 0.52kg

COLOR	CODE
White	151484E_
Gold	151484J_
Black	151484K_
Black	151484B_

LIGHT COLOUR	LUMEN CRI	CODE
2700K	710 >90	3
3000K	740 >90	5

back

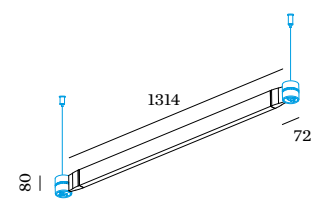

**A | 1.0**  
 LED PCB | dimmable  
 220-240VAC | 50-60Hz  
 aluminium | opal PMMA cover

IP20 SDCM3 L80|50K 1.70kg

phase-cut dim | 20W  
 3000K | CRI >90 | 1090lm

	CODE
	500384W5
	500384B5

DALI-2 | 22W | incl. driver  
 3000K | CRI >90 | 1090lm

	CODE
	500385W5
	500385B5

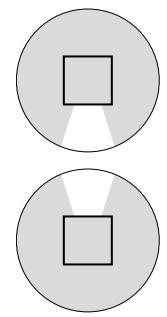

**B | CONNECTOR POINT**  
 phase-cut dim up to max. 4 fixtures  
 DALI up to max. 2 fixtures

	CODE
	900190W1
	900190B1

**C | STEEL SUSPENSION CABLE**

	CODE
2.0m	90015102

**D1 | POWER FEEDER**  
 for phase-cut dim | incl. steel suspension cable 2.0m | max. 10 luminaires per power feeder

	CODE
	90018010
	90018011

**D2 | POWER FEEDER**  
 for DALI | incl. steel suspension cable 2.0m | max. 10 luminaires per power feeder

	CODE
	90018012
	90018013

## SURFACE EXAMPLES

configuration as seen from top view | minimum angle 45°

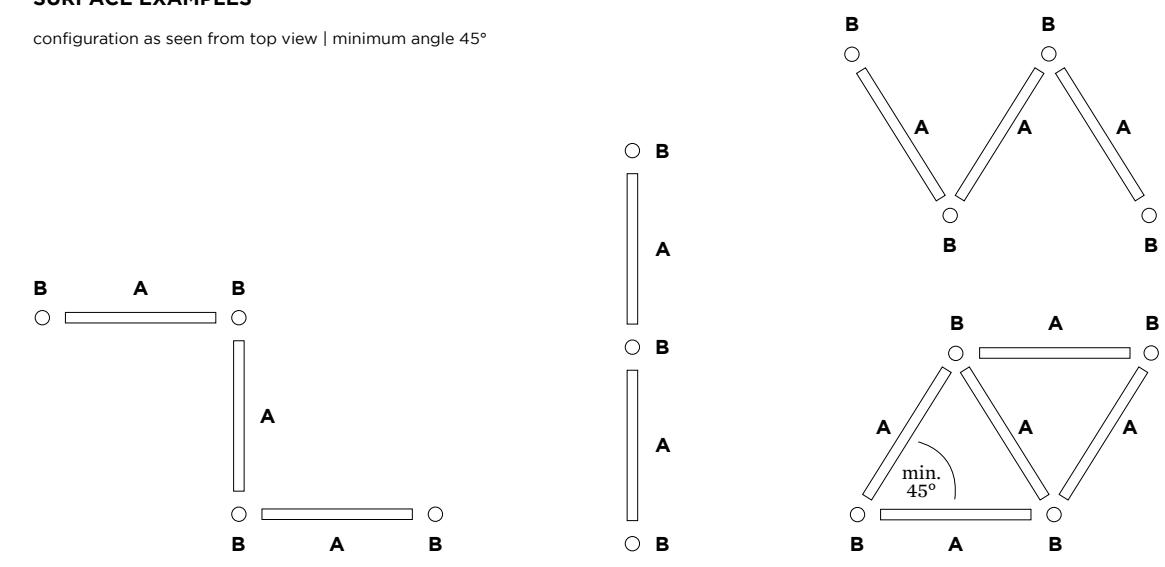

## SUSPENDED EXAMPLES

configuration as seen from top view | minimum angle 45°  
 can be used up or down (direct or indirect)

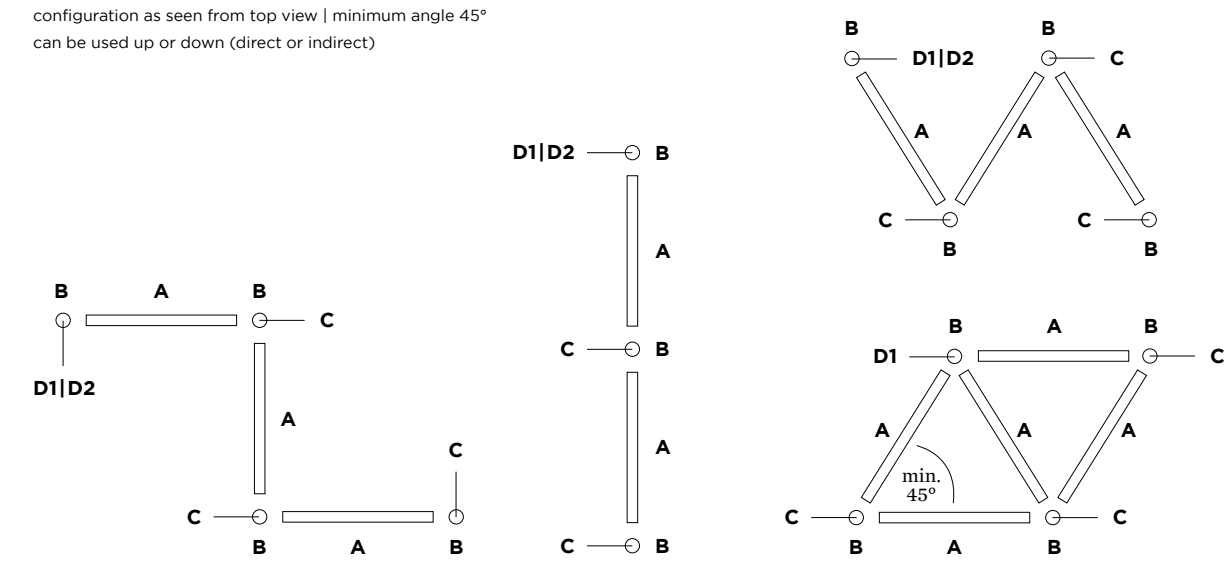

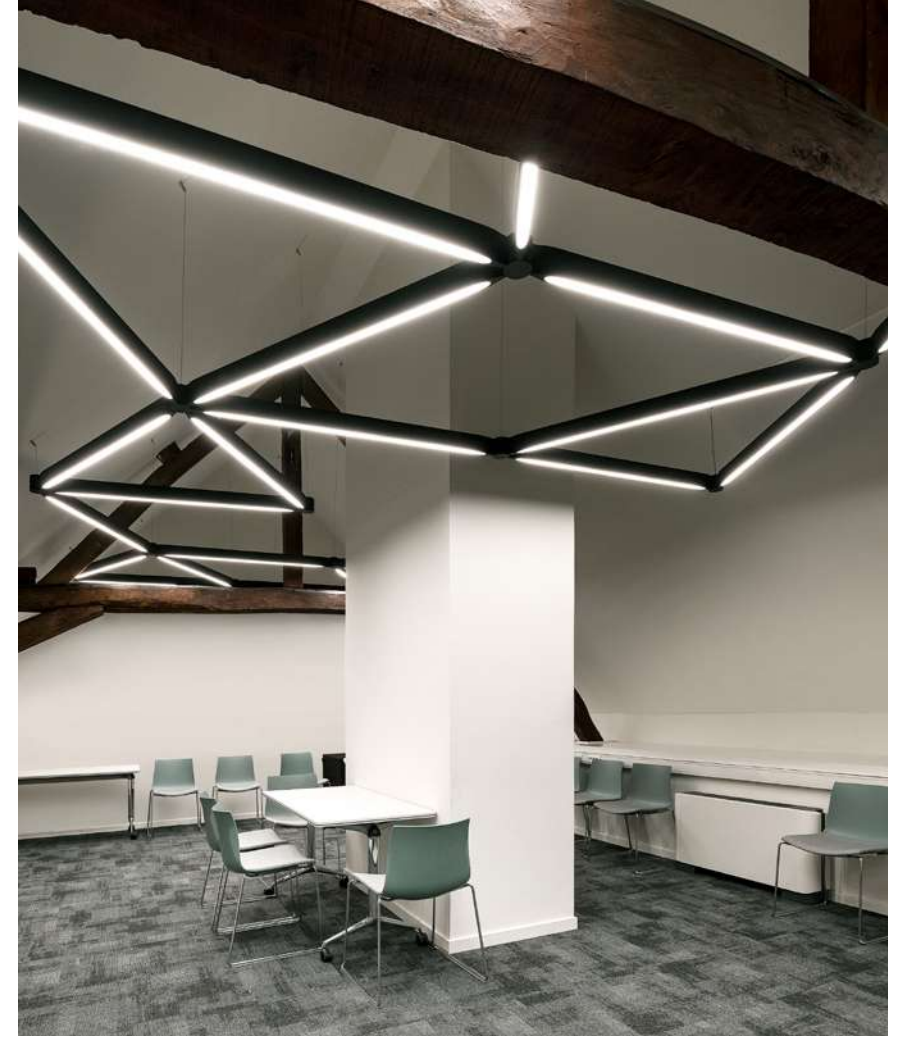

OFFICE BELGIUM





## 1.0 PROFILE

aluminium | opal diffuser included  
end caps and mounting clips

0.11kg/m

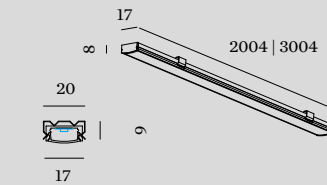

CODE

2m	911991W2
2m	911991B2
3m	911991W3
3m	911991B3

## 2.0 PROFILE

aluminium | opal diffuser included  
end caps and mounting clips

0.19kg/m

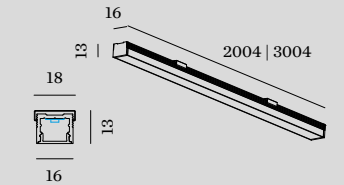

CODE

2m	911992W2
2m	911992B2
3m	911992W3
3m	911992B3

## ALWAYS USE

LED COB strip 24V | IP20  
10W/m | 800lm/m

CODE

20W   2m	9003S21
30W   3m	9003S31
50W   5m	9003S41

LED COB strip 24V | IP20  
15W/m | 1250lm/m

CODE

30W   2m	9003S22
45W   3m	9003S32
75W   5m	9003S42

LIGHT COLOUR

CRI CODE

2700K	>90	3
3000K	>90	5

driver | 24V

CODE

35W	90212801
100W	90212902
25W dim	90222701
50W dim	90222901

specs on page 810

## ALWAYS USE

LED COB strip 24V | IP20  
10W/m | 800lm/m

CODE

20W   2m	9003S21
30W   3m	9003S31
50W   5m	9003S41

LED COB strip 24V | IP20  
15W/m | 1250lm/m

CODE

30W   2m	9003S22
45W   3m	9003S32
75W   5m	9003S42

LIGHT COLOUR

CRI CODE

2700K	>90	3
3000K	>90	5

driver | 24V

CODE

35W	90212801
100W	90212902
25W dim	90222701
50W dim	90222901

specs on page 810

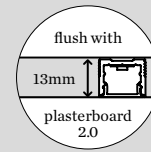
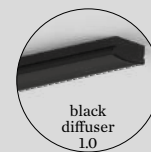

## OPTIONAL

Black diffuser | only for 1.0

CODE

2m	911902B1
3m	911903B1

Double side tape for profile fixation

CODE

3m	90019199
----	----------

more accessories on page 820

for net output of LED strip on profiles,  
check [weverducre.com/ilane](http://weverducre.com/ilane)

# ILANE

Ceiling surface / recessed

## 3.0 PROFILE

aluminium | opal diffuser included  
end caps and mounting clips

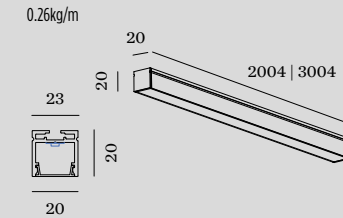

		CODE	
2m	911993W2	2m	911993B2
3m	911993W3	3m	911993B3

## 4.0 PROFILE

aluminium | opal diffuser included  
end caps and mounting clips

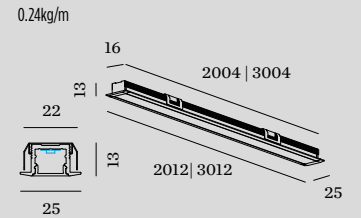

		CODE	
2m	911994W2	2m	911994B2
3m	911994W3	3m	911994B3

## ALWAYS USE

LED COB strip 24V | IP20  
10W/m | 800lm/m

		CODE	
20W   2m	9003S21	30W   3m	9003S31
50W   5m	9003S41		

LED COB strip 24V | IP20  
15W/m | 1250lm/m

		CODE	
30W   2m	9003S22	45W   3m	9003S32
75W   5m	9003S42		

LIGHT COLOUR	CRI	CODE
2700K	>90	3
3000K	>90	5

driver | 24V

		CODE	
35W	90212801	100W	90212902
25W dim	90222701	50W dim	90222901

specs on page 810

## ALWAYS USE

LED COB strip 24V | IP20  
10W/m | 800lm/m

		CODE	
20W   2m	9003S21	30W   3m	9003S31
50W   5m	9003S41		

LED COB strip 24V | IP20  
15W/m | 1250lm/m

		CODE	
30W   2m	9003S22	45W   3m	9003S32
75W   5m	9003S42		

LIGHT COLOUR	CRI	CODE
2700K	>90	3
3000K	>90	5

driver | 24V

		CODE	
35W	90212801	100W	90212902
25W dim	90222701	50W dim	90222901

specs on page 810

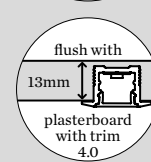
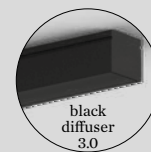

## OPTIONAL

Black diffuser | only for 3.0

		CODE	
2m	911912B1	3m	911913B1

Double side tape for profile fixation

		CODE	
3m	90019199		

more accessories on page 820

for net output of LED strip on profiles,  
check [weverducre.com/ilane](http://weverducre.com/ilane)

## SINGLE LUMINAIRES



## SINGLE SUSPENSIONS



## MULTIBASE USE

more infos on p. 459





# TRACE CHANDELIER

Ceiling suspended

new



reddot winner 2023

201 | 253 | 257

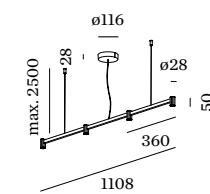
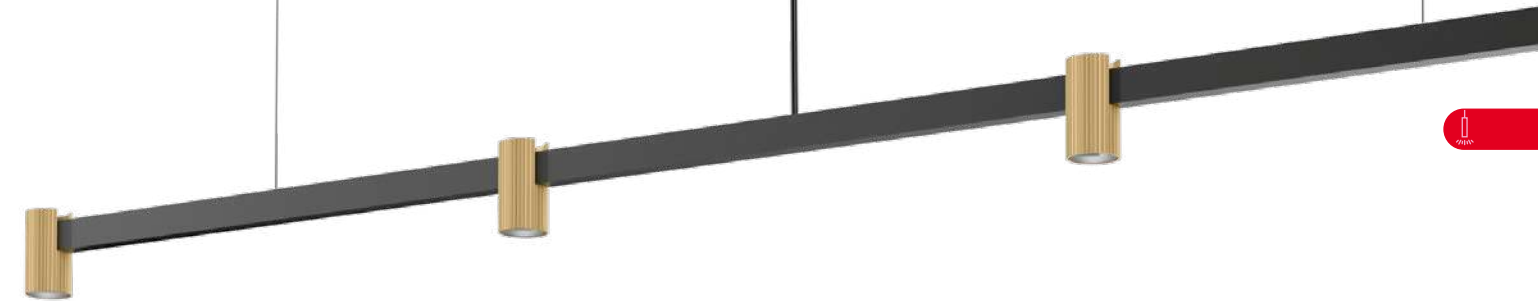

## 1.0

LED COB 11W | phase-cut dim  
220-240VAC | 50-60Hz | incl. driver  
aluminium

IP20  $\Delta$ 30° SDCM2 L80|50K 0.64kg

CODE	
	253564CH_
	253564B_

LIGHT COLOUR	LUMEN CRI	CODE
2700K	4x180 >90	3
3000K	4x200 >90	5

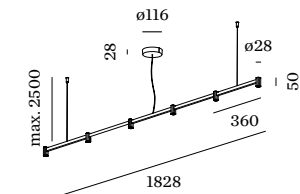

## 2.0

LED COB 15W | phase-cut dim  
220-240VAC | 50-60Hz | incl. driver  
aluminium

IP20  $\Delta$ 30° SDCM2 L80|50K 0.84kg

CODE	
	253664CH_
	253664B_

LIGHT COLOUR	LUMEN CRI	CODE
2700K	6x180 >90	3
3000K	6x200 >90	5

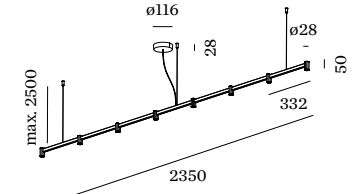

## 3.0

LED COB 15W | phase-cut dim  
220-240VAC | 50-60Hz | incl. driver  
aluminium

IP20  $\Delta$ 30° SDCM2 L80|50K 1.10kg

CODE	
	253764CH_
	253764B_

LIGHT COLOUR	LUMEN CRI	CODE
2700K	8x180 >90	3
3000K	8x200 >90	5

Rev. 001/2024-05

back

WEVER & DUCRÉ 372 — 373



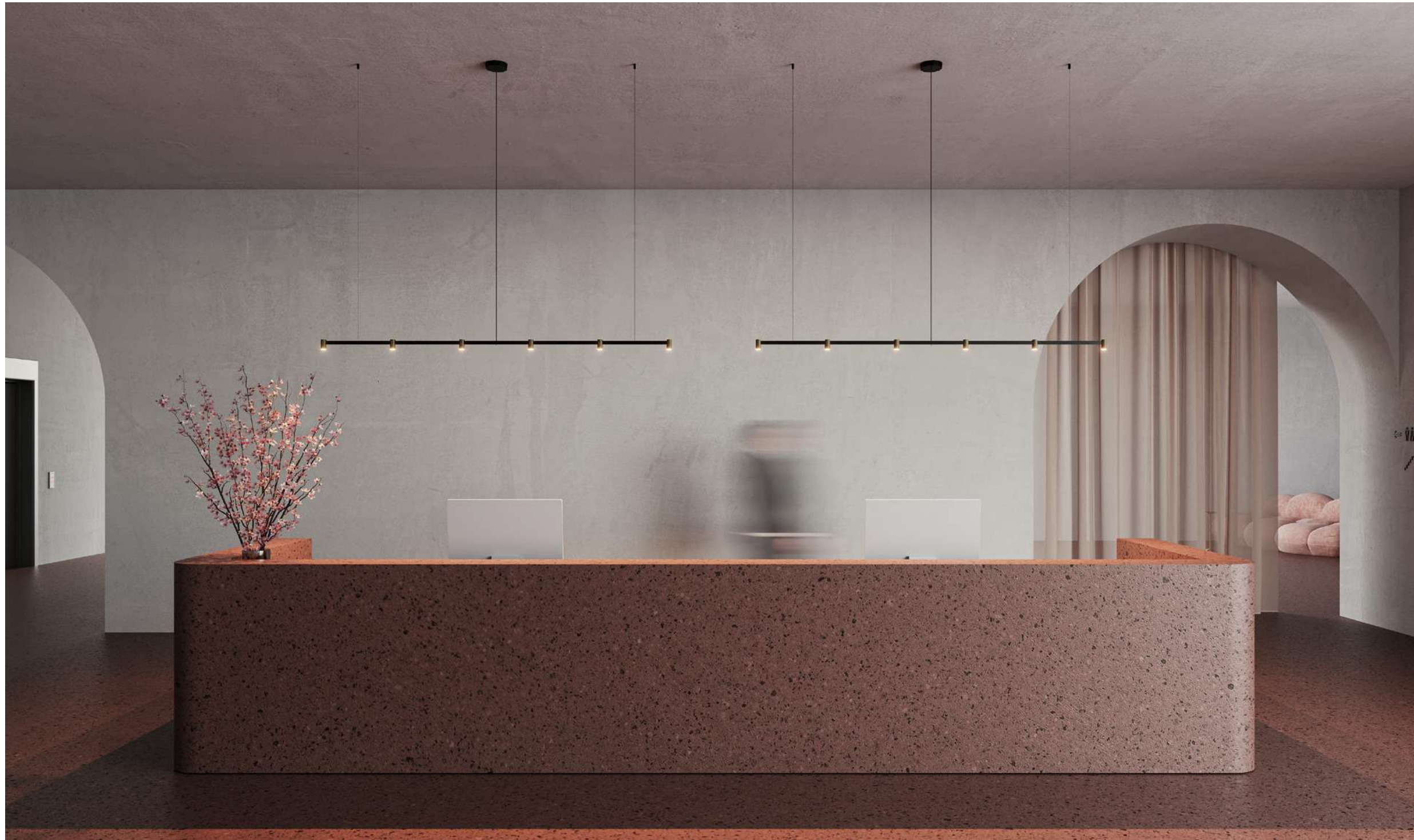



# NET

Ceiling suspended

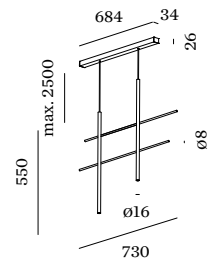
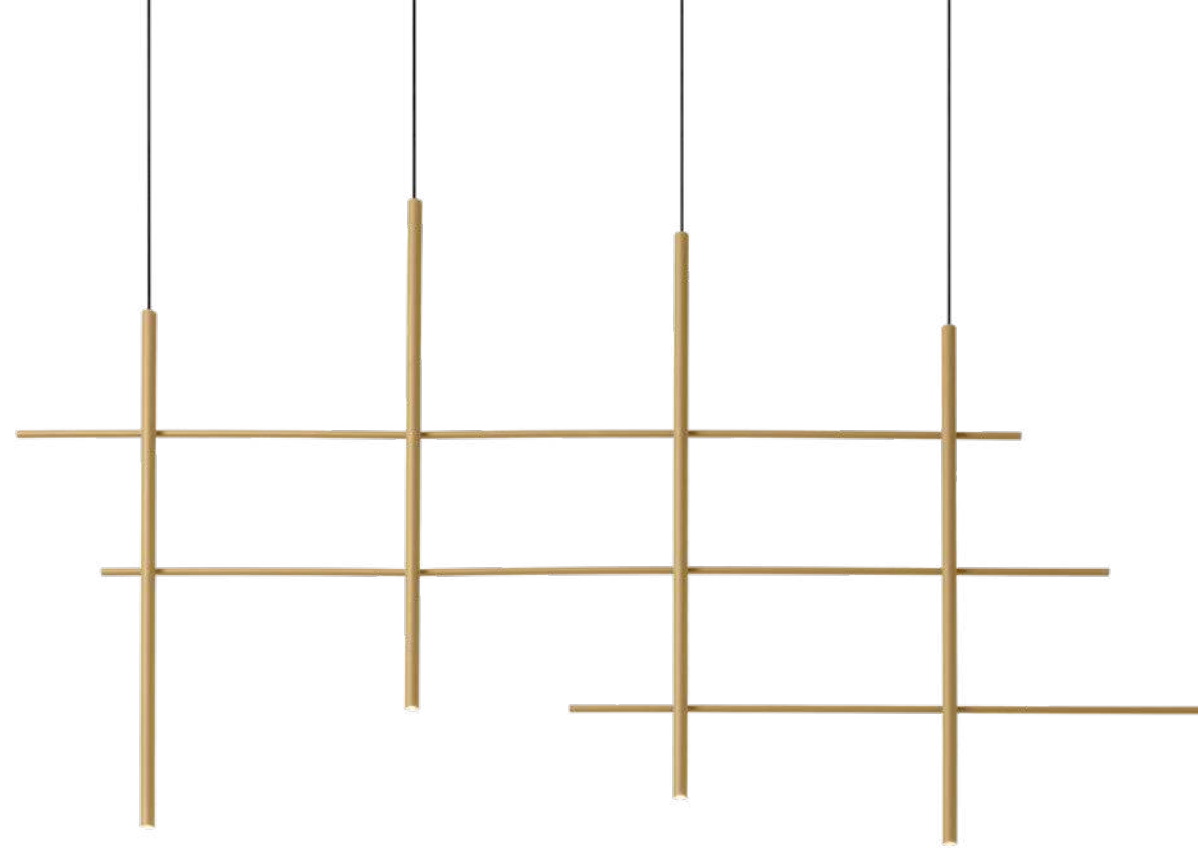



**2.0**

LED PCB 14W | phase-cut dim  
220-240VAC | 50-60Hz | incl. driver  
aluminium

IP20  $\Delta$  85° SDCM3 L80|50K 1.41kg

2700K | CRI >90 | 2x235lm

	CODE
	231264W3
	231264M3
	231264B3

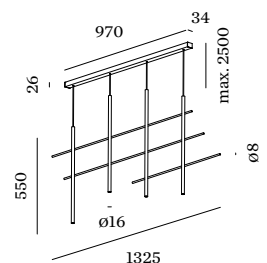



**4.0**

LED PCB 28W | phase-cut dim  
220-240VAC | 50-60Hz | incl. driver  
aluminium

IP20  $\Delta$  85° SDCM3 L80|50K 2.55kg

2700K | CRI >90 | 4x235lm

	CODE
	231464W3
	231464M3
	231464B3





# FINELLE

Ceiling suspended

new

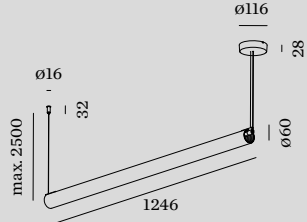

1.0

LED PCB 11W | phase-cut dim  
220-240VAC | 50-60Hz | incl. driver  
aluminium | ribbed glass

IP20 SDCM3 L80/100K 1.95kg

2700K | CRI >90 | 950lm

	CODE
	272184M3
	272184B3

back





# FIL

Ceiling suspended



251



615

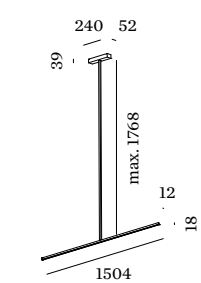
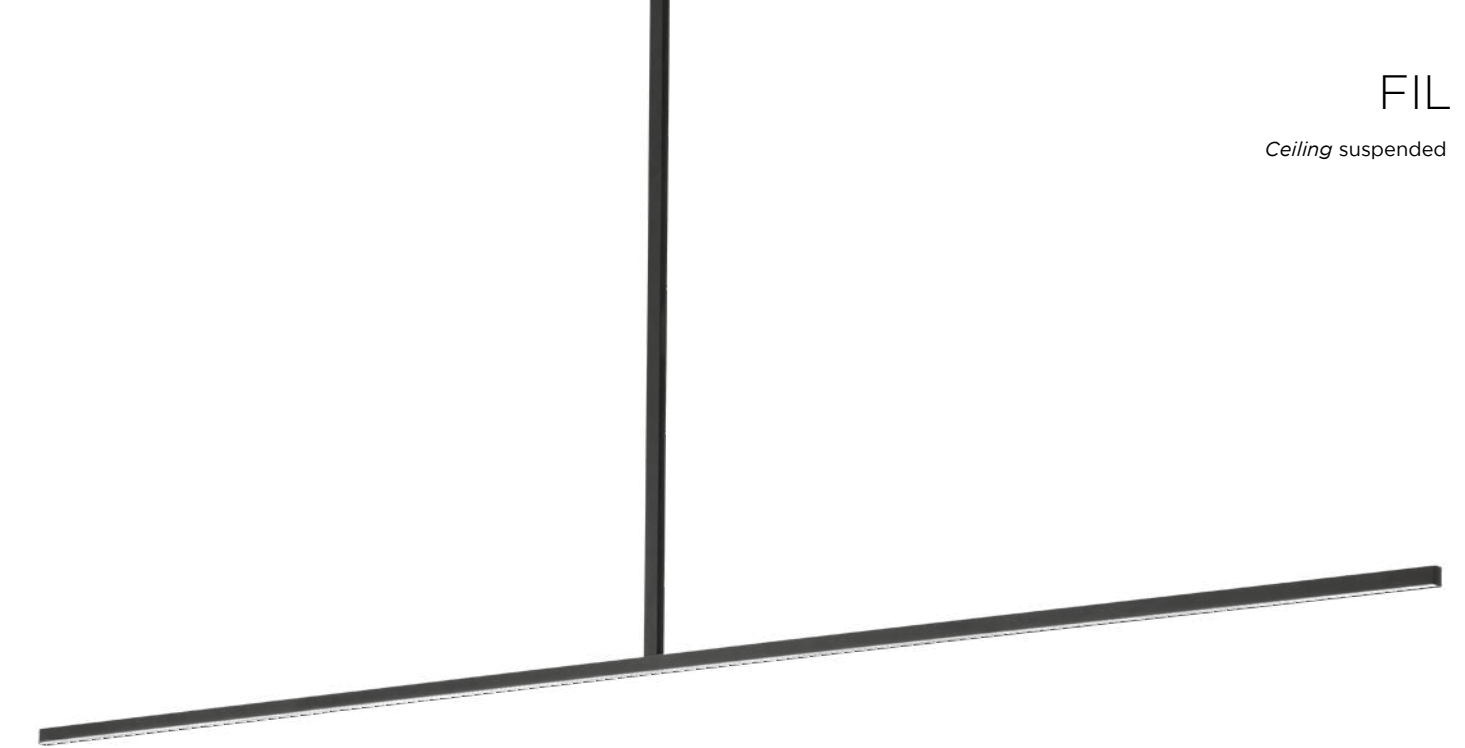

**1.0**

LED PCB 22W | phase-cut dim  
220-240VAC | 50-60Hz | incl. driver  
aluminium

⊕ IP20 SDCM3 L80|50K 1.39kg

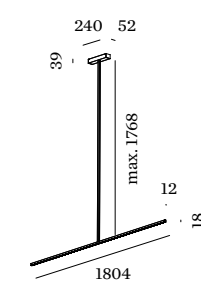

**2.0**

LED PCB 27W | phase-cut dim  
220-240VAC | 50-60Hz | incl. driver  
aluminium

⊕ IP20 SDCM3 L80|50K 1.47kg

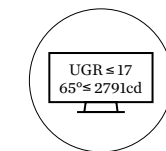

CODE			CODE		
2543M4B_			2544M4B_		
LIGHT COLOUR	LUMEN CRI	CODE	LIGHT COLOUR	LUMEN CRI	CODE
2700K	1090 >90	3	2700K	1310 >90	3
3000K	1200 >90	5	3000K	1440 >90	5

back



FINLIN

Ceiling suspended



reddot winner 2023



277



609



657

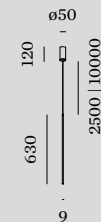

**1.0**

LED PCB 5W | phase-cut dim  
220-240VAC | 50-60Hz | incl. driver  
aluminium | opal PMMA diffuser

⊕ IP20 SDCM3 L80|50K 0.31kg

	CODE
2.5m	270184CH_
2.5m	270184B_
10m	270484B5

**OPTIONAL**

cover plate adapter for concrete housing

CODE	
900194B0	

LIGHT COLOUR	LUMEN CRI	CODE
2700K	430 >90	3
3000K	440 >90	5



**2.0**

LED PCB 8W | phase-cut dim  
220-240VAC | 50-60Hz | incl. driver  
aluminium | opal PMMA diffuser

⊕ IP20 SDCM3 L80|50K 0.34kg

	CODE
2.5m	270284CH_
2.5m	270284B_
10m	270584B5

LIGHT COLOUR	LUMEN CRI	CODE
2700K	655 >90	3
3000K	670 >90	5



**3.0**

LED PCB 9W | phase-cut dim  
220-240VAC | 50-60Hz | incl. driver  
aluminium | opal PMMA diffuser

⊕ IP20 SDCM3 L80|50K 0.38kg

	CODE
2.5m	270384CH_
2.5m	270384B_
10m	270684B5

LIGHT COLOUR	LUMEN CRI	CODE
2700K	870 >90	3
3000K	890 >90	5

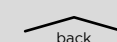

back



# KUJO

Ceiling suspended

new

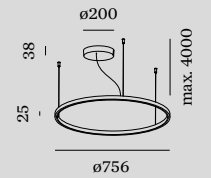
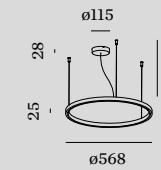
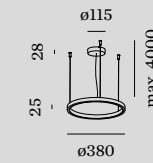

## 1.0

LED PCB 11W | phase-cut dim  
220-240VAC | 50-60Hz | incl. driver  
aluminium | silicone cover

IP20 SDCM3 L80/100K 0.59kg

2700K | CRI >90 | 1100lm

CODE

White	271182W3
Gold	271182M3
Black	271182Q3
Dark Grey	271182B3

## 2.0

LED PCB 15W | phase-cut dim  
220-240VAC | 50-60Hz | incl. driver  
aluminium | silicone cover

IP20 SDCM3 L80/100K 0.86kg

2700K | CRI >90 | 1500lm

CODE

White	271282W3
Gold	271282M3
Black	271282Q3
Dark Grey	271282B3

## 3.0

LED PCB 20W | phase-cut dim  
220-240VAC | 50-60Hz | incl. driver  
aluminium | silicone cover

IP20 SDCM3 L80/100K 1.05kg

2700K | CRI >90 | 2000lm

CODE

White	271382W3
Gold	271382M3
Black	271382Q3
Dark Grey	271382B3

white fixtures with white cable/base  
and silver steel wire | other fixtures with  
black cable/base/steel wire

Rev. 001/2024-05

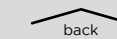



# KUJO

Ceiling suspended

new

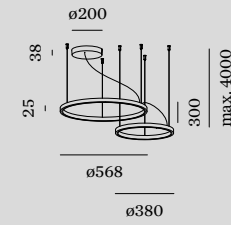

### 2.1

LED PCB 26W | phase-cut dim  
220-240VAC | 50-60Hz | incl. driver  
aluminium | silicone cover

IP20 SDCM3 L80|100K 1.18kg

2700K | CRI >90 | 2600lm

	CODE
	271482W3
	271482M3
	271482Q3
	271482B3

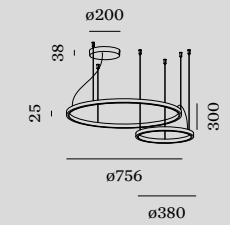

### 3.1

LED PCB 31W | phase-cut dim  
220-240VAC | 50-60Hz | incl. driver  
aluminium | silicone cover

IP20 SDCM3 L80|100K 1.21kg

2700K | CRI >90 | 3100lm

	CODE
	271582W3
	271582M3
	271582Q3
	271582B3

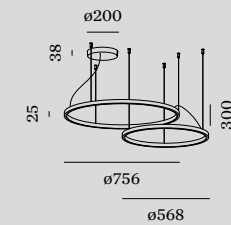

### 3.2

LED PCB 35W | phase-cut dim  
220-240VAC | 50-60Hz | incl. driver  
aluminium | silicone cover

IP20 SDCM3 L80|100K 1.58kg

2700K | CRI >90 | 3500lm

	CODE
	271682W3
	271682M3
	271682Q3
	271682B3

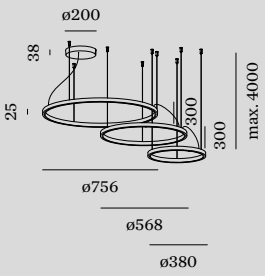

### 3.2.1

LED PCB 46W | phase-cut dim  
220-240VAC | 50-60Hz | incl. driver  
aluminium | silicone cover

IP20 SDCM3 L80|100K 1.84kg

2700K | CRI >90 | 4600lm

	CODE
	271782W3
	271782M3
	271782Q3
	271782B3

white fixtures with white cable/base/connector and silver steel wire | other fixtures with black cable/base/connector and black steel wire

Rev. 001/2024-05

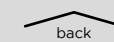



BENEDICTION | KKOL STUDIO SEOUL | SOUTH KOREA

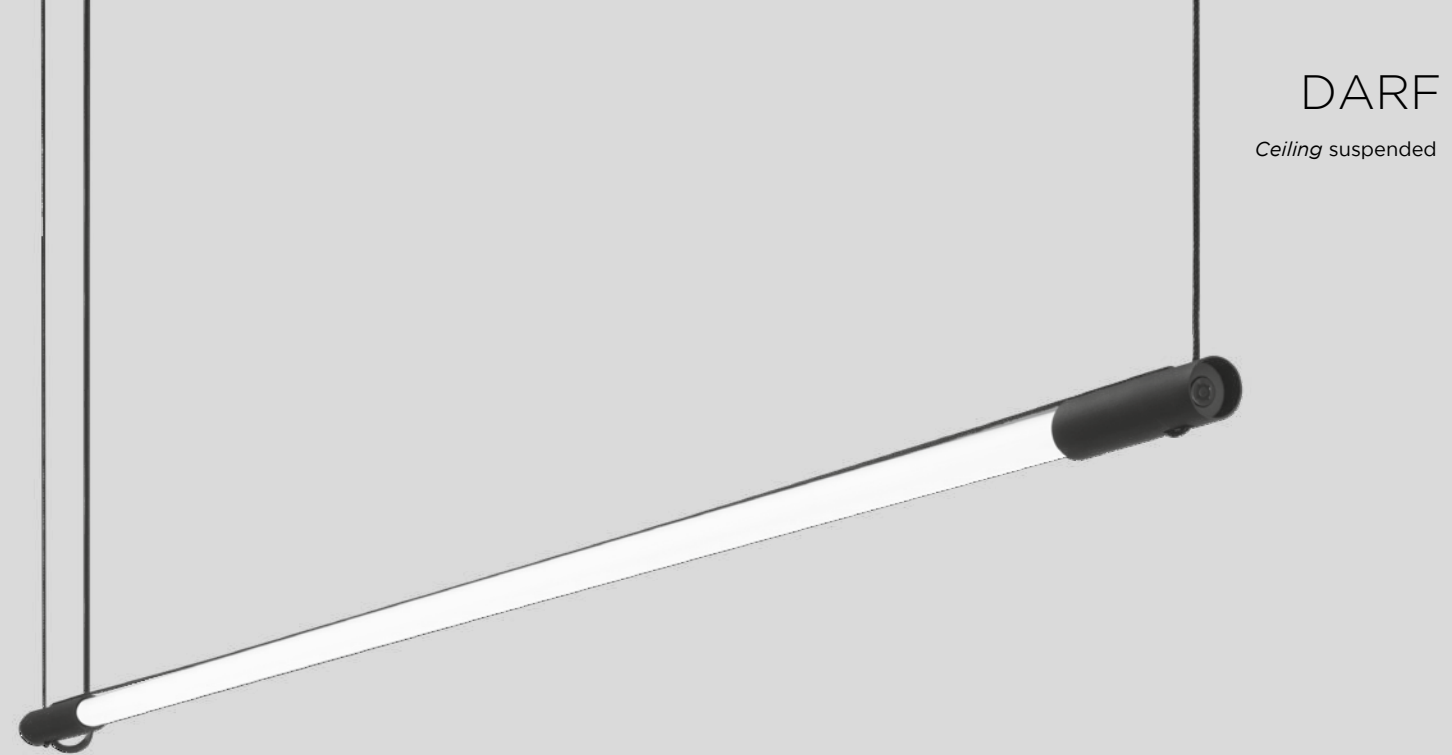

DARF

Ceiling suspended

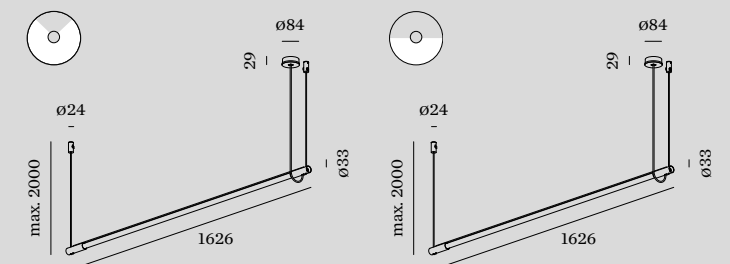

1.1

LED TUBE 22W | non dim  
220-240VAC | 50-60Hz  
aluminium | black textile cable

IP20 SDCM3 L70|60K 0.42kg

3000K | CRI >80 | 3560lm

CODE

2561T7B4

4000K | CRI >80 | 3950lm

CODE

2561T7B6

1.2

LED TUBE 23W | phase-cut dim  
220-240VAC | 50-60Hz  
aluminium | black textile cable

IP20 SDCM3 L70|50K 0.42kg

2700K | CRI >90 | 2780lm

CODE

2561T8B3

3000K | CRI >90 | 2940lm

CODE

2561T8B5

Rev.001/2024-05

ARCHITECT | PHILIPP WEINBERGER & STUDIO MARCH GUT

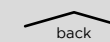



► DESIGN WITH LOVE



# ELLO

Ceiling suspended



reddot award 2015  
winner



DESIGN  
AWARD  
2015

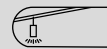

362

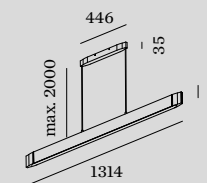

**13.0**

LED PCB 20W | phase-cut dim  
220-240VAC | 50-60Hz  
aluminium | opal PMMA cover

IP20 SDCM3 L80|50K 2.00kg

3000K | CRI >90 | 1090lm

CODE

	500484W5
	500484B5

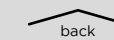
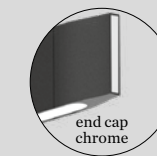

back



# GIGANT

Ceiling suspended

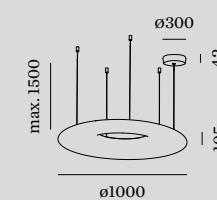

## 10.0

LED PCB 42W | DALI-2 | switch dim  
220-240VAC | 50-60Hz | incl. driver  
steel | opal LLDPE body | UL 94  
HB std.glow wire test 630°

IP20 SDCM3 L80/60K 8.80kg

3000K | CRI >80 | 5300lm

CODE  
213385W4

4000K | CRI >80 | 5600lm

CODE  
213385W6

## OPTIONAL

CODE  
suspension  
set 4m 90015114  
longer suspension on request

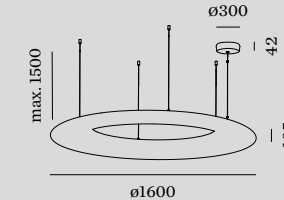

## 16.0

LED PCB 84W | DALI-2 | switch dim  
220-240VAC | 50-60Hz | incl. driver  
steel | opal LLDPE body | UL 94  
HB std.glow wire test 630°

IP20 SDCM3 L80/60K 15.30kg

3000K | CRI >80 | 10600lm

CODE  
213485W4

4000K | CRI >80 | 11300lm

CODE  
213485W6

## OPTIONAL

CODE  
suspension  
set 4m 90015114  
longer suspension on request





# TRACÉ

Ceiling suspended



reddot winner 2023



201 | 253 | 257



517

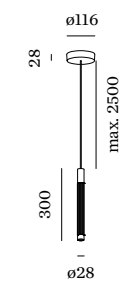
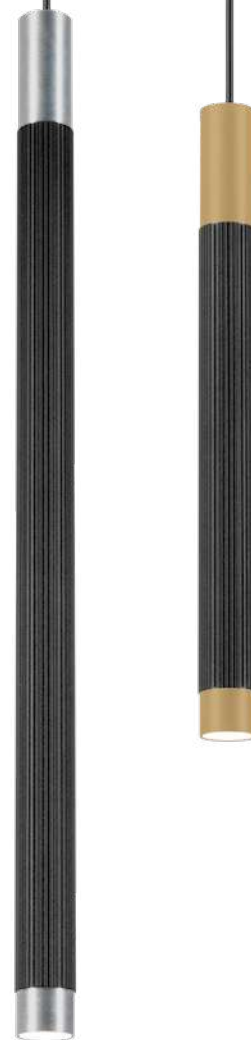

## 1.1

LED COB 9W | phase-cut dim  
220-240VAC | 50-60Hz | incl. driver  
aluminium

IP20  $\Delta$  33° SDCM2 L80|50K 0.33kg

	CODE
	253164W_
	253164BL_
	253164CH_
	253164B_

LIGHT COLOUR	LUMEN CRI	CODE
2700K	420 >90	3
3000K	440 >90	5

white fixtures with white cable/base  
other fixtures with black cable/base  
more colour combinations on request

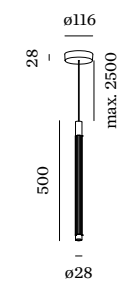

## 1.2

LED COB 9W | phase-cut dim  
220-240VAC | 50-60Hz | incl. driver  
aluminium

IP20  $\Delta$  33° SDCM2 L80|50K 0.42kg

	CODE
	253264W_
	253264BL_
	253264CH_
	253264B_

LIGHT COLOUR	LUMEN CRI	CODE
2700K	420 >90	3
3000K	440 >90	5

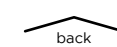

back



Rev. 001/2024-05

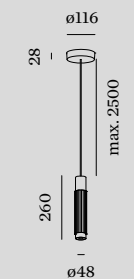

**2.0 LED**

LED COB 8W | phase-cut dim  
220-240VAC | 50-60Hz | incl. driver  
aluminium

IP20 75° SDCM2 L80|50K 0.65kg

	CODE
	253474W_
	253474BL
	253474CH_
	253474B_

LIGHT COLOUR	LUMEN CRI	CODE
2700K	530 >90	3
3000K	570 >90	5

white fixtures with white cable/base  
other fixtures with black cable/base  
more colour combinations on request

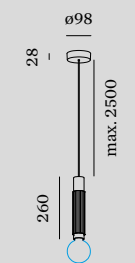

**2.0 E27**

G95 max. 12W | E27  
220-240VAC | 50-60Hz  
aluminium

IP20 0.59kg

	CODE
	2533E0WO
	2533E0BLO
	2533E0CHO
	2533E0BO

**OPTIONAL**

G95 5.5W | E27 | phase-cut dim | clear  
CODE  
2700K | 534lm 9003E160

G95 5.4W | E27 | phase-cut dim  
filament | gold tinted  
CODE  
2200K | 380lm 9003E111

**TRACE**

Ceiling suspended



reddot winner 2023

201 | 253 | 257

517

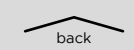



# CONE

Ceiling suspended

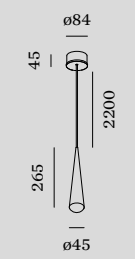
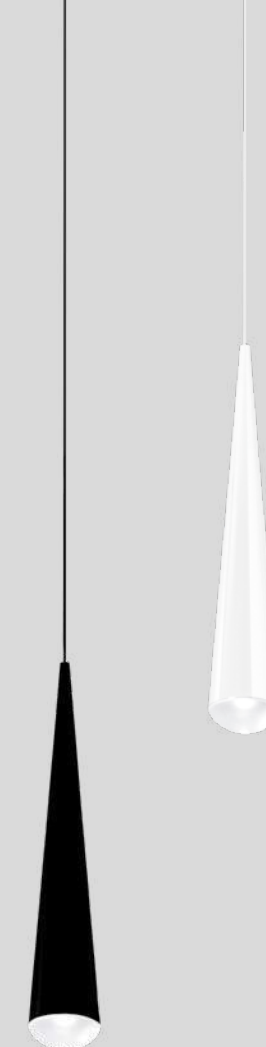

## 1.0

LED COB 8W | phase-cut dim  
220-240VAC | 50-60Hz | incl. driver  
aluminium | chrome plated | glass

IP20  $\sim$  38° SDCM3 L80/60K 0.55kg

2700K | CRI >90 | 405lm

	CODE
	200184W3
	200184B3

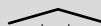
 back



► DESIGN WITH LOVE

MAGAZIN AUF EF OER ERKENSCHWICK | GERMANY



# CORK

Ceiling suspended

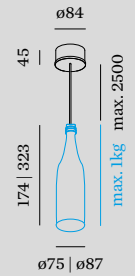

## 1.0

LED PCB 4W  
100-240VAC | 50-60Hz | incl. driver  
aluminium  
fits bottles inner ø16.5 - 19.5 mm

⊕ IP20 ⚡ 36° SDCM3 L80I60K 0.24kg

2700K | CRI >80 | 145lm

CODE

210363B2

## OPTIONAL

CODE

bottle 1  
75/174 | glass 90019013  
bottle 2  
87/323 | glass 90019014

back

WEVER & DUCRÉ 404 – 405



MARBELLA DESIGN & ART FAIR | MV INTERIORISMO MARBELLA | SPAIN

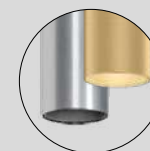
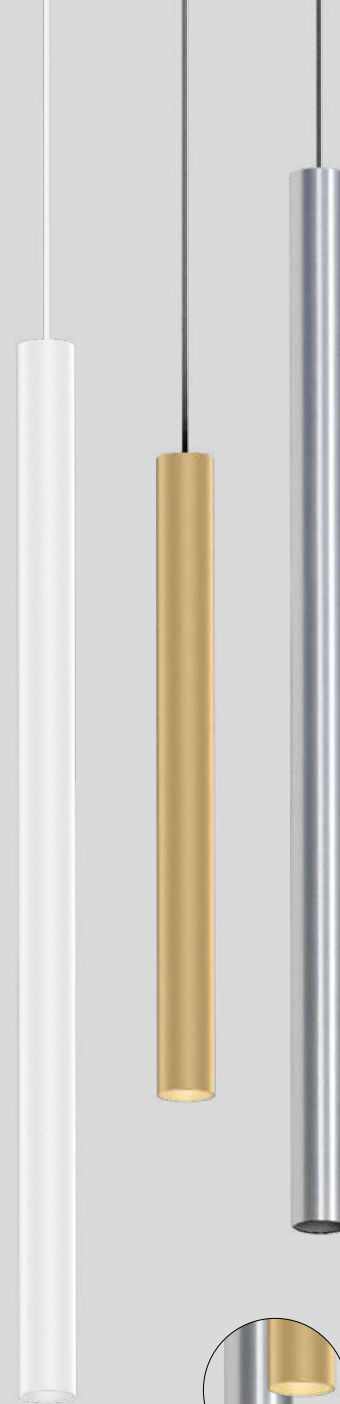

white fixtures with white cable/base  
 other fixtures with black cable/base  
 more colour combinations on request

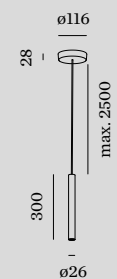

**3.0**

LED COB 9W | phase-cut dim  
 220-240VAC | 50-60Hz | incl. driver  
 aluminium

IP20  $\Delta$  33° SDCM2 L80|50K 0.26kg

CODE	
	279264W_
	279264L_
	279264M_
	279264B_

LIGHT COLOUR	LUMEN CRI	CODE
2700K	490 >90	3
3000K	520 >90	5

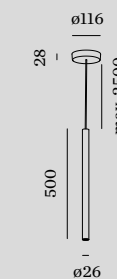

**5.0**

LED COB 9W | phase-cut dim  
 220-240VAC | 50-60Hz | incl. driver  
 aluminium

IP20  $\Delta$  33° SDCM2 L80|50K 0.36kg

CODE	
	279364W_
	279364L_
	279364M_
	279364B_

LIGHT COLOUR	LUMEN CRI	CODE
2700K	490 >90	3
3000K	520 >90	5

MATCH

Ceiling suspended



reddot winner 2023



As awarded by The Chicago Athenaeum:  
 Museum of Architecture and Design

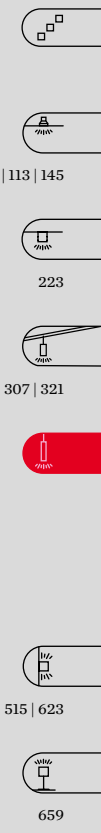



SPICY LEMON | STAY STUDIO KORTRIJK | BELGIUM

# SOLLI

Ceiling suspended

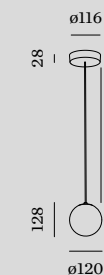

## 1.0

LED COB 9W | phase-cut dim  
220-240VAC | 50-60Hz | incl. driver  
aluminium  
artisanal hand blown glass

IP20 SDCM2 L80|50K 0.48kg

	CODE
	238284FD_
	238284TD_
	238284WB_

LIGHT COLOUR	LUMEN CRI	CODE
2700K	360 >90	3
3000K	370 >90	5

back



# SOLLI COCOON

Ceiling suspended

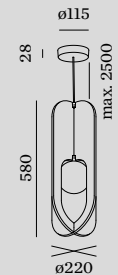
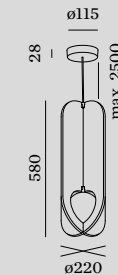

## 1.0

LED COB 9W | phase-cut dim  
220-240VAC | 50-60Hz | incl. driver  
aluminium | PET felt material  
artisanal hand blown glass

IP20 SDCM2 L80|50K 0.70kg

## 2.0

LED COB 9W | phase-cut dim  
220-240VAC | 50-60Hz | incl. driver  
aluminium | PET felt material  
artisanal hand blown glass

IP20 SDCM2 L80|50K 0.63kg

## OPTIONAL

3.0 full acoustic element  
aluminium | PET felt material

CODE	238500MF0	238500LF0	238500OF0

more specs on page 824

CODE	238384MF_	238384LF_	238384OF_	CODE	238484MF_	238484LF_	238484OF_
LIGHT COLOUR	LUMEN CRI	CODE		LIGHT COLOUR	LUMEN CRI	CODE	
2700K	290 >90	3		2700K	290 >90	3	
3000K	310 >90	5		3000K	310 >90	5	



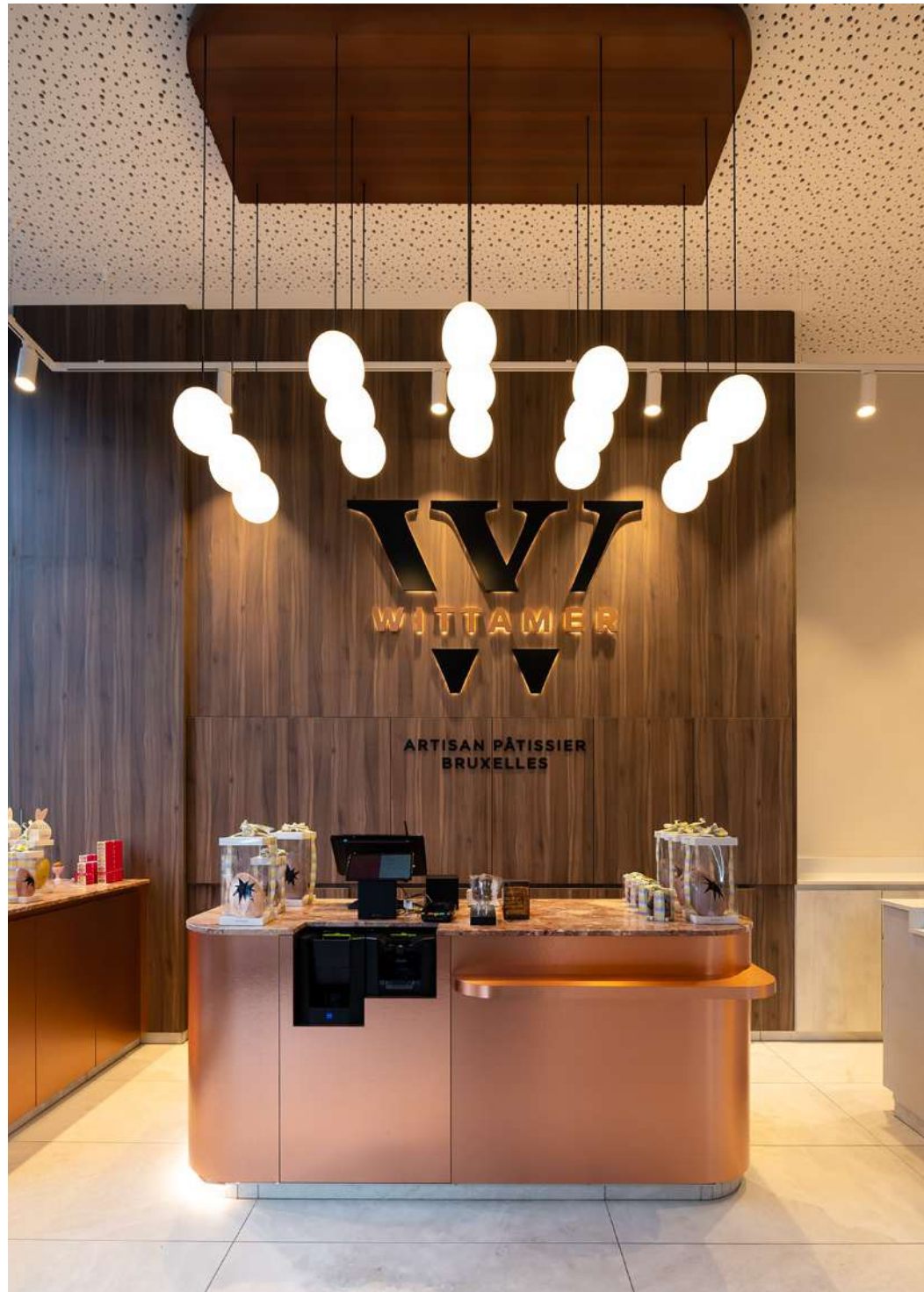

BAKERY WITTAMER BRUSSELS | BELGIUM



DRO  
Ceiling suspended



**1.0**

QT14 max. 5W | G9  
220-240VAC | 50-60Hz  
aluminium  
artisanal Italian hand blown glass

⊕ IP20 0.50kg

CODE  
2521G0WB0

**OPTIONAL**

QT14 3W | G9 | phase-cut dim | clear  
CODE  
2700K | 300lm 9010G802  
3000K | 280lm 9010G804

**2.0**

C35 max. 6W | E14  
220-240VAC | 50-60Hz  
aluminium  
artisanal Italian hand blown glass

⊕ IP20 1.07kg

CODE  
2522C0WB0

**OPTIONAL**

C35 5.5W | E14 | phase-cut dim | opal  
CODE  
2700K | 450lm 9003C103

**3.0**

A60 max. 12W | E27  
220-240VAC | 50-60Hz  
aluminium  
artisanal Italian hand blown glass

⊕ IP20 2.20kg

CODE  
2523E0WB0

**OPTIONAL**

A60 9W | E27 | phase-cut dim | opal  
CODE  
2700K | 800lm 9003E152

**4.0**

A65 max. 15W | E27  
220-240VAC | 50-60Hz  
aluminium  
artisanal Italian hand blown glass

⊕ IP20 3.25kg

CODE  
2524E0WB0

**OPTIONAL**

A65 14.6W | E27 | phase-cut dim | opal  
CODE  
2700K | 1378lm 9003E153



Rev. 001/2024-05  
13&9 DESIGN

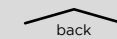



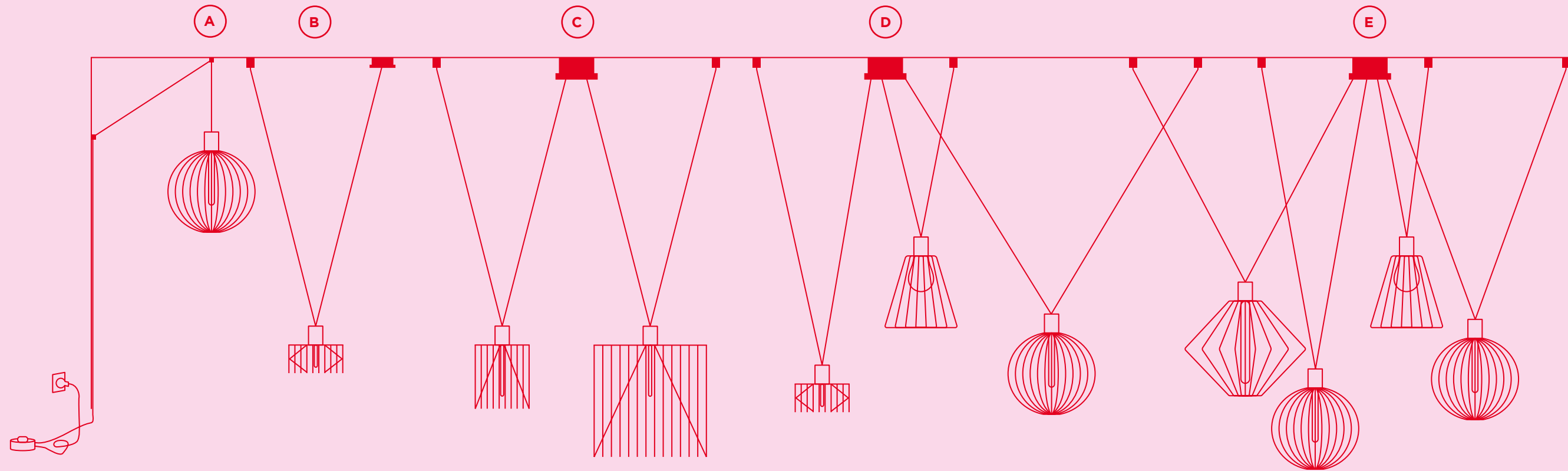

# Choose your decenter



1.0 CONE

	CODE
	245100V0
	245100B0

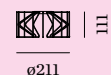

2.0 WIRO

	CODE
	209600B0



1.8 WIRO

	CODE
	209200V0
	209200B0

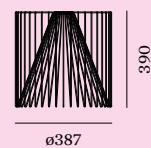

3.8 WIRO

	CODE
	209300V0
	209300B0



1.1 DIAMOND

	CODE
	244100P0
	244100B0



4.0 GLOBE

	CODE
	243100B0

**A** **CABLE PLUG AND PLAY**  
 E27 LED 4-25W | connector set for one shade | black textile cable incl. cable plug with dimmer | 2 cable brackets included  
 CODE  
 8.5m 90015165

**B** **DECENTER SET 1.0**  
 A60 max. 60W | E27 220-240VAC | 50-60Hz suspension set for 1 shade round ceiling base | black textile cable 1 base + 1 end stop included  
 CODE  
 2.6m 90052050  
 6m 90052051

**C** **DECENTER SET 2.0**  
 2x A60 max. 60W | E27 220-240VAC | 50-60Hz suspension set for 2 shades round ceiling base | black textile cable 1 multibase + 2 end stops included  
 CODE  
 2.6m 90052055  
 6m 90052056

**D** **DECENTER SET 3.0**  
 3x A60 max. 60W | E27 220-240VAC | 50-60Hz suspension set for 3 shades round ceiling base | black textile cable 1 multibase + 3 end stops included  
 CODE  
 2.6m 90052060  
 6m 90052063

**E** **DECENTER SET 4.0**  
 4x A60 max. 60W | E27 220-240VAC | 50-60Hz suspension set for 4 shades round ceiling base | black textile cable 1 multibase + 4 end stops included  
 CODE  
 2.6m 90052067  
 6m 90052078



# WIRO

Ceiling suspended

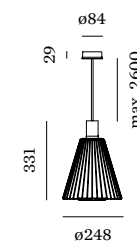

## 1.0 CONE

T30 max. 60W | E27  
220-240VAC | 50-60Hz  
aluminium | steel

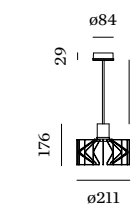

IP20 1.60kg



## 2.0 WIRO

A60 max. 60W | E27  
220-240VAC | 50-60Hz  
aluminium | steel

IP20 0.82kg

	CODE
	2451E0V0
	2451E0B0
more suspension options on page 415	

## OPTIONAL

T30-225 5.3W | E27 | phase-cut dim  
gold tinted

	CODE
2200K   382lm	9003E129
2700K   425lm	9003E136

	CODE
	2096E0B0
more suspension options on page 415	

## OPTIONAL

A60 3.8W | E27 | phase-cut dim  
gold tinted

	CODE
2200K   247lm	9003E109
	CODE
A60 5.6W   E27   phase-cut dim   clear	
2700K   483lm	9003E138



OTHER LENGTHS ONLINE  
weverducre.com/more-wiro



# WIRO

Ceiling suspended

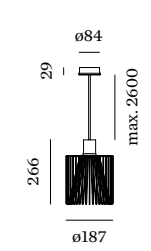

## 1.8 WIRO

A60 max. 60W | E27  
220-240VAC | 50-60Hz  
aluminium | steel

⊕ IP20 1.70kg

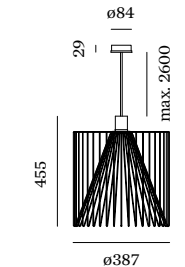

## 3.8 WIRO

A60 max. 60W | E27  
220-240VAC | 50-60Hz  
aluminium | steel

⊕ IP20 2.75kg

	CODE
	2092E0V0
	2092E0B0

more suspension options on page 415

	CODE
	2093E0V0
	2093E0B0

more suspension options on page 415

## OPTIONAL

A60 3.8W | E27 | phase-cut dim  
gold tinted

	CODE
2200K   247lm	9003E109

A60 5.6W | E27 | phase-cut dim | clear

	CODE
2700K   483lm	9003E138

T30-225 5.3W | E27 | phase-cut dim  
gold tinted

	CODE
2200K   382lm	9003E129
2700K   425lm	9003E136

## OPTIONAL

A60 3.8W | E27 | phase-cut dim  
gold tinted

	CODE
2200K   247lm	9003E109

A60 5.6W | E27 | phase-cut dim | clear

	CODE
2700K   483lm	9003E138

T30-225 5.3W | E27 | phase-cut dim  
gold tinted

	CODE
2200K   382lm	9003E129
2700K   425lm	9003E136



OTHER LENGTHS ONLINE  
weverducre.com/more-wiro

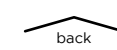



RESTAURANT MARCHÉ 17 TURNHOUT | BELGIUM

# WIRO

Ceiling suspended

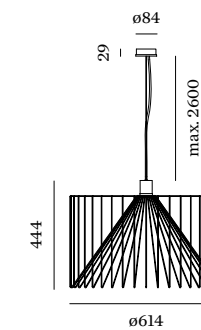

## 6.1 WIRO

◊ A60 max. 60W | E27  
220-240VAC | 50-60Hz  
aluminium | steel

⊕ IP20 3.22kg

	CODE
	2094E0V0
	2094E0B0

## OPTIONAL

A60 3.8W | E27 | phase-cut dim  
gold tinted

	CODE
2200K   247lm	9003E109

A60 5.6W | E27 | phase-cut dim | clear

	CODE
2700K   483lm	9003E138

T30-300 7.2W/74W | E27  
phase-cut dim | gold tinted

	CODE
2200K   585lm	9003E130
2700K   613lm	9003E135



OTHER LENGTHS ONLINE  
weverducre.com/more-wiro

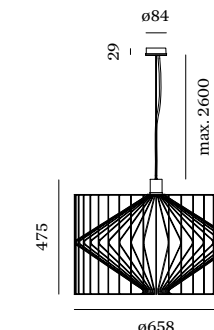

## 6.5 WIRO

◊ A60 max. 60W | E27  
220-240VAC | 50-60Hz  
aluminium | steel

⊕ IP20 4.42kg

	CODE
	2095E0V0
	2095E0B0

## OPTIONAL

A60 3.8W | E27 | phase-cut dim  
gold tinted

	CODE
2200K   247lm	9003E109

A60 5.6W | E27 | phase-cut dim | clear

	CODE
2700K   483lm	9003E138

T30-300 7.2W/74W | E27  
phase-cut dim | gold tinted

	CODE
2200K   585lm	9003E130
2700K   613lm	9003E135

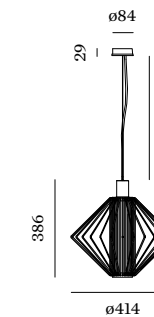

### 1.0 DIAMOND

☐ T30 max. 60W | E27  
220-240VAC | 50-60Hz  
aluminium | steel

⊕ IP20 3.52kg

	CODE
	2291E0P0
	2291E0B0

### OPTIONAL

T30-300 7.2W/74W | E27  
phase-cut dim | gold tinted

	CODE
2200K   585lm	9003E130
2700K   613lm	9003E135



OTHER LENGTHS ONLINE  
weverducre.com/more-wiro

# WIRO

Ceiling suspended



As awarded by The Chicago Athenaeum:  
Museum of Architecture and Design



265



569

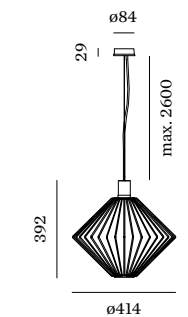

### 1.1 DIAMOND

☐ T30 max. 60W | E27  
220-240VAC | 50-60Hz  
aluminium | steel

⊕ IP20 2.72kg

	CODE
	2441E0P0
	2441E0B0

more suspension options on page 415

### OPTIONAL

T30-300 7.2W/74W | E27  
phase-cut dim | gold tinted

	CODE
2200K   585lm	9003E130
2700K   613lm	9003E135



# WIRO

Ceiling suspended

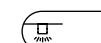

265



569

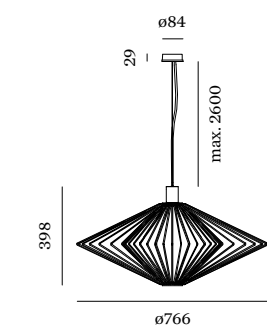

## 2.0 DIAMOND

T30 max. 60W | E27  
220-240VAC | 50-60Hz  
aluminium | steel

⊕ IP20 5.62kg

	CODE
	2292E0P0
	2292E0B0

## OPTIONAL

T30-300 7.2W/74W | E27  
phase-cut dim | gold tinted

	CODE
2200K   585lm	9003E130
2700K   613lm	9003E135

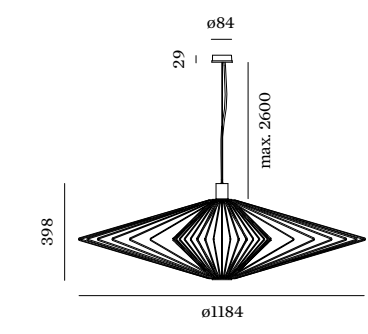

## 3.0 DIAMOND

T30 max. 60W | E27  
220-240VAC | 50-60Hz  
aluminium | steel

⊕ IP20 7.02kg

	CODE
	2293E0P0
	2293E0B0

## OPTIONAL

T30-300 7.2W/74W | E27  
phase-cut dim | gold tinted

	CODE
2200K   585lm	9003E130
2700K   613lm	9003E135



OTHER LENGTHS ONLINE  
weverducre.com/more-wiro

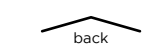

back



SHOWROOM GRANDO KEUKENS SINT-MARTENS-LATEM | BELGIUM

# WIRO

Ceiling suspended

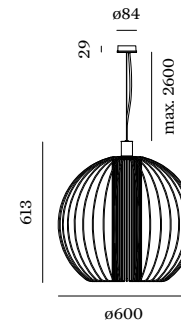

## 1.0 GLOBE

T30 max. 60W | E27  
220-240VAC | 50-60Hz  
aluminium | steel

IP20 5.92kg

CODE  
2281E0B0

## OPTIONAL

A60 3.8W | E27 | phase-cut dim  
gold tinted

CODE  
2200K | 247lm 9003E109

A60 5.6W | E27 | phase-cut dim | clear  
CODE  
2700K | 483lm 9003E138

T30-300 7.2W/74W | E27  
phase-cut dim | gold tinted

CODE  
2200K | 585lm 9003E130  
2700K | 613lm 9003E135

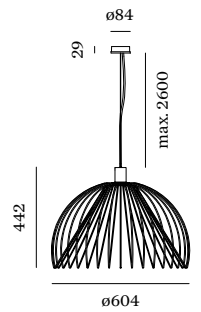

## 2.0 GLOBE

A60 max. 60W | E27  
220-240VAC | 50-60Hz  
aluminium | steel

IP20 4.42kg

CODE  
2282E0B0

## OPTIONAL

A60 3.8W | E27 | phase-cut dim  
gold tinted

CODE  
2200K | 247lm 9003E109

A60 5.6W | E27 | phase-cut dim | clear  
CODE  
2700K | 483lm 9003E138

T30-300 7.2W/74W | E27  
phase-cut dim | gold tinted

CODE  
2200K | 585lm 9003E130  
2700K | 613lm 9003E135



OTHER LENGTHS ONLINE  
weverducre.com/more-wiro

BERND STEINHUBER

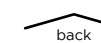

back

WEVER & DUCRÉ 426 – 427



265



569



OFFICE KBC VAN CAUTEREN | INTERIEUR LIN DILBEEK | BELGIUM

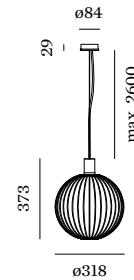

#### 4.0 GLOBE

□ T30 max. 60W | E27  
220-240VAC | 50-60Hz  
aluminium | steel

⊕ IP20 1.92kg

CODE

2431E0B0

more suspension options on page 415

#### OPTIONAL

T30-225 5.3W | E27 | phase-cut dim  
gold tinted

CODE

2200K | 382lm 9003E129  
2700K | 425lm 9003E136

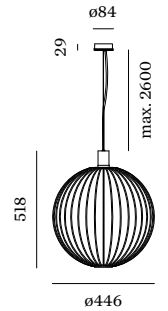

#### 5.0 GLOBE

□ T30 max. 60W | E27  
220-240VAC | 50-60Hz  
aluminium | steel

⊕ IP20 3.32kg

CODE

2432E0B0

more suspension options on page 415

#### OPTIONAL

T30-300 7.2W/7.4W | E27 | phase-cut dim  
gold tinted

CODE

2200K | 585lm 9003E130  
2700K | 613lm 9003E135



OTHER LENGTHS ONLINE

[weverducre.com/more-wiro](http://weverducre.com/more-wiro)

BERND STEINHUBER

WIRO

Ceiling suspended



265



569

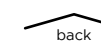

back

WEVER & DUCRÉ 428 – 429





# MIRRO

Ceiling suspended

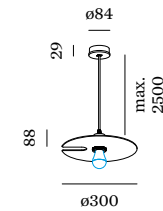

## 1.0

A60 max. 15W | E27  
220-240VAC | 50-60Hz  
aluminium | one side reflective  
composite panel

IP20 0.70kg

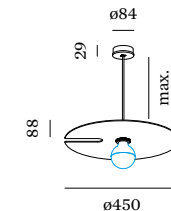

## 2.0

G95 max. 15W | E27  
220-240VAC | 50-60Hz  
aluminium | one side reflective  
composite panel

IP20 1.00kg

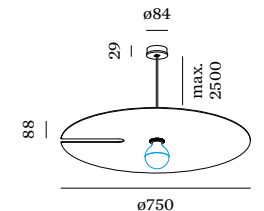

## 3.0

G95 max. 15W | E27  
220-240VAC | 50-60Hz  
aluminium | one side reflective  
composite panel

IP20 2.10kg



GB



NB



LB

Color	CODE
[Gold swatch]	6341E0GB0
[Black swatch]	6341E0NB0
[Blue swatch]	6341E0LB0

### OPTIONAL

Power	Temperature	Beam Angle	CODE
A60 5.5W   E27   phase-cut dim	gold mirror		
		2700K   409lm	9003E139

Power	Temperature	Beam Angle	CODE
A60 5.5W   E27   phase-cut dim	silver mirror		
		2700K   409lm	9003E140

Color	CODE
[Gold swatch]	6342E0GB0
[Black swatch]	6342E0NB0
[Blue swatch]	6342E0LB0

### OPTIONAL

Power	Temperature	Beam Angle	CODE
G95 5.1W/5.6W   E27   phase-cut dim	gold mirror		
		2200K   371lm	9003E156
		2700K   464lm	9003E142

Power	Temperature	Beam Angle	CODE
G95 5.6W   E27   phase-cut dim	silver mirror		
		2700K   464lm	9003E157

Color	CODE
[Gold swatch]	6343E0GB0
[Black swatch]	6343E0NB0
[Blue swatch]	6343E0LB0

### OPTIONAL

Power	Temperature	Beam Angle	CODE
G95 5.1W/5.6W   E27   phase-cut dim	gold mirror		
		2200K   371lm	9003E156
		2700K   464lm	9003E142

Power	Temperature	Beam Angle	CODE
G95 5.6W   E27   phase-cut dim	silver mirror		
		2700K   464lm	9003E157



**OTHER LENGTHS ONLINE**  
weverducre.com/more-mirro



# MIRRO SOFT

Ceiling suspended

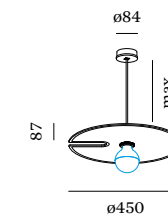

## 2.0

G95 max. 15W | E27  
220-240VAC | 50-60Hz  
aluminium | PET felt material

IP20 0.68kg/0.81kg

CODE	
	6342E0MF0
	6342E0LF0
	6342E0IF0
	6342E0AF0

## OPTIONAL

G95 5.1W/5.6W | E27 | phase-cut dim  
gold mirror

CODE	
2200K   371lm	9003E156
2700K   464lm	9003E142

G95 5.6W | E27 | phase-cut dim  
silver mirror

CODE	
2700K   464lm	9003E157

G95 5.5W | E27 | phase-cut dim  
clear

CODE	
2700K   534lm	9003E160

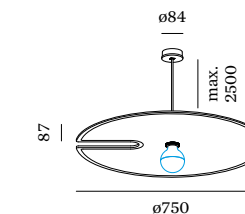

## 3.0

G95 max. 15W | E27  
220-240VAC | 50-60Hz  
aluminium | PET felt material

IP20 1.21kg/1.34kg

CODE	
	6343E0MF0
	6343E0LF0
	6343E0IF0
	6343E0AF0

## OPTIONAL

G95 5.1W/5.6W | E27 | phase-cut dim  
gold mirror

CODE	
2200K   371lm	9003E156
2700K   464lm	9003E142

G95 5.6W | E27 | phase-cut dim  
silver mirror

CODE	
2700K   464lm	9003E157

G95 5.5W | E27 | phase-cut dim  
clear

CODE	
2700K   534lm	9003E160



OTHER LENGTHS ONLINE  
weverducre.com/more-mirro

Rev. 001/2024-05  
13&9 DESIGN

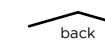

back



COMBINE IT WITH OTHER OPTIONS  
[weverducre.com/mirro](https://weverducre.com/mirro)



HAIRDRESSER TON SUR TON | SIMON DE BACKERE KORTRIJK | BELGIUM

JULES WABBES

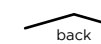

WEVER & DUCRÉ 436 – 437

J.J.W.

Ceiling suspended

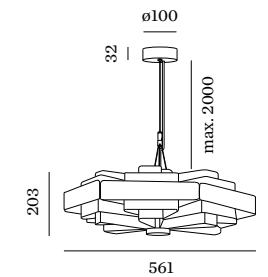

04

6x A60 max. 15W | E27  
220-240VAC | 50-60Hz  
aluminium

IP20 4.50kg

CODE

2052E0S0

2052E0G0

**OPTIONAL**

A60 3.8W | E27 | phase-cut dim  
gold tinted

CODE

2200K | 247lm 9003E109

A60 5.6W | E27 | phase-cut dim | clear

CODE

2700K | 483lm 9003E138



MERCURE CHANTILLY | PROJECT MANAGED BY ATYPIO HOTELS RESORTS WITH ABP ARCHITECTS | L'OBSERVATOIRE DE LA NUIT VINEUIL-SAINT-FIRMIN | FRANCE



J.J.W.

Ceiling suspended

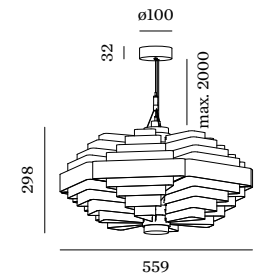

042

6x A60 max. 15W | E27  
220-240VAC | 50-60Hz  
aluminium

IP20 8,10kg

	CODE
	2056E0S0
	2056E0G0

OPTIONAL

A60 3.8W | E27 | phase-cut dim  
gold tinted

	CODE
2200K   247lm	9003E109

A60 5.6W | E27 | phase-cut dim | clear

	CODE
2700K   483lm	9003E138



MERCURE CHANTILLY | PROJECT MANAGED BY ATYPIO HOTELS RESORTS WITH ABP ARCHITECTS | L'OBSERVATOIRE DE LA NUIT  
VINEUIL-SAINT-FIRMIN | FRANCE



► DESIGN WITH LOVE



MERCURE CHANTILLY | PROJECT MANAGED BY ATYPIO HOTELS RESORTS WITH ABP ARCHITECTS | L'OBSERVATOIRE DE LA NUIT VINEUIL-SAINT-FIRMIN | FRANCE



J.J.W.

Ceiling suspended

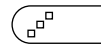

273



573

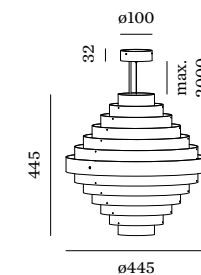

05

3x A60 max. 15W | E27  
220-240VAC | 50-60Hz  
aluminium

IP20 8.50kg

	CODE
	2053E0S0
	2053E0G0

**OPTIONAL**

A60 3.8W | E27 | phase-cut dim  
gold tinted

	CODE
2200K   247lm	9003E109

A60 5.6W | E27 | phase-cut dim | clear

	CODE
2700K   483lm	9003E138



APARTMENT RONDA SANT PERE | DANIEL NASSAR | ALSINASECH LIGHTING PROJECTS SPAIN

# ROOMOR

Ceiling suspended



reddot award 2019  
winner lighting design

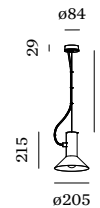

## 1.1 PAR16

PAR16 max. 15W | GU10  
100-240VAC | 50-60Hz  
aluminium

IP20 0.80kg

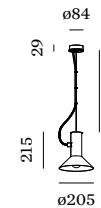

## 1.1 E27

A60 max. 15W | E27  
220-240VAC | 50-60Hz  
aluminium

IP20 0.84kg

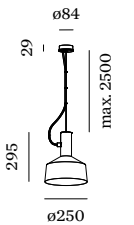

## 1.2 E27

A60 max. 15W | E27  
220-240VAC | 50-60Hz  
aluminium | grey felt

IP20 1.11kg(0.90kg)



OTHER LENGTHS ONLINE  
weverducre.com/more-roomor

CODE
248120GG1
248120BK1
248120BB1

### OPTIONAL

CODE
2700K   460lm 901228W3
2700K   437lm 901228B3
3000K   500lm 901228W5
3000K   457lm 901228B5

CODE
2481E0GG1
2481E0BK1
2481E0BB1

### OPTIONAL

CODE
A60 9W   E27   phase-cut dim   opal 9003E152
2700K   800lm

CODE
2481E0BF2
2481E0BK2
2481E0BB2

### OPTIONAL

CODE
A60 9W   E27   phase-cut dim   opal 9003E152
2700K   800lm

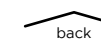





OTHER LENGTHS ONLINE  
[weverducre.com/more-roomor](https://weverducre.com/more-roomor)

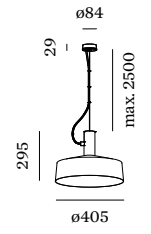

**1.3 E27**

A60 max. 15W | E27  
 220-240VAC | 50-60Hz  
 aluminium | grey felt

⊕ IP20 1.60kg/1.48kg



	CODE
	2481E0BF3
	2481E0BK3
	2481E0BB3

**OPTIONAL**

A60 9W | E27 | phase-cut dim | opal  
 CODE  
 2700K | 800lm 9003E152

ROOMOR

Ceiling suspended



reddot award 2019  
 winner lighting design

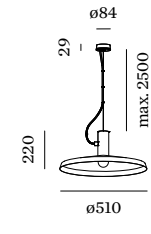

**1.4 E27**

A60 max. 15W | E27  
 220-240VAC | 50-60Hz  
 aluminium

⊕ IP20 1.72kg

	CODE
	2481E0BK4
	2481E0BB4

**OPTIONAL**

A60 9W | E27 | phase-cut dim | opal  
 CODE  
 2700K | 800lm 9003E152

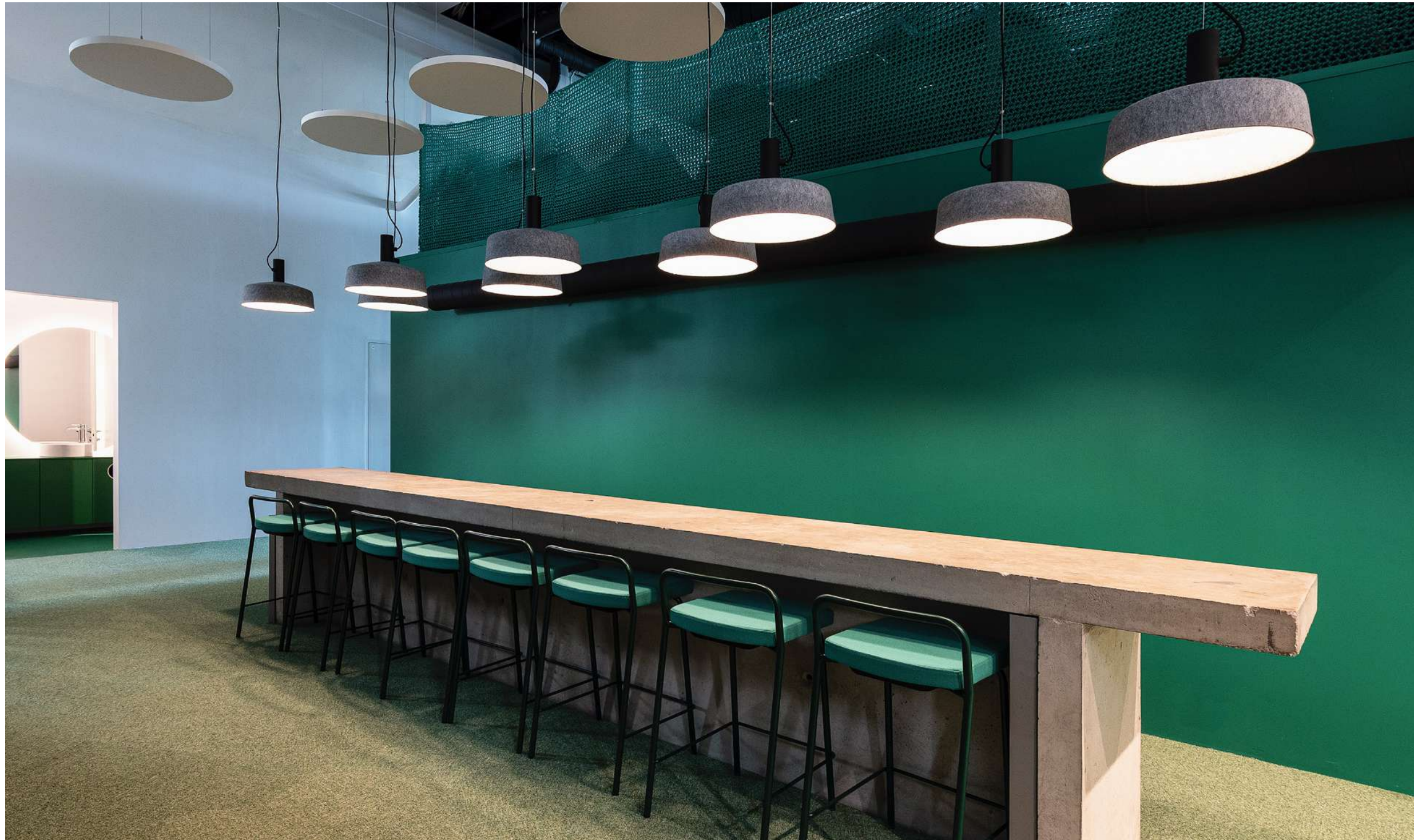



WEVER & DUCRÉ OFFICE ITALY SAN DONÀ DI PIAVE - VENEZIA | ITALY



# ROOMOR OFFICE

Ceiling suspended



reddot winner 2021



As awarded by The Chicago Athenaeum: Museum of Architecture and Design

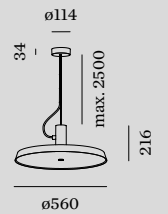
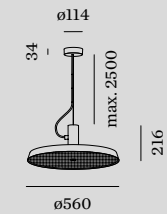

## 1.0 MICROPRISMATIC

LED PCB 35W | DALI-2 | push dim  
220-240VAC | 50-60Hz | incl. driver  
aluminium  
microprismatic PMMA cover

IP20 SDCM3 L80/60K UGR ≤ 19 4.62kg

3000K | CRI >90 | 3660lm

	CODE
	1681M5W5
	1681M5B5

4000K | CRI >90 | 3660lm

	CODE
	1681M5W7
	1681M5B7

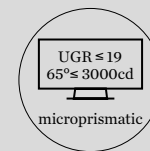

## 1.0 OPAL

LED PCB 35W | DALI-2 | push dim  
220-240VAC | 50-60Hz | incl. driver  
aluminium | opal PMMA cover

IP20 SDCM3 L80/60K 4.62kg

3000K | CRI >90 | 3700lm

	CODE
	168185W5
	168185B5

4000K | CRI >90 | 3700lm

	CODE
	168185W7
	168185B7



LINK LAB CREATIVE OFFICES | STAY STUDIO KORTRIJK | BELGIUM



# BISHOP

Ceiling suspended



reddot award 2015  
honourable mention

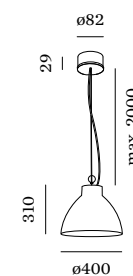

## 4.0

A60/G95 max. 25W | E27  
220-240VAC | 50-60Hz  
composite

⊕ IP20 1.08kg

CODE	
	2184E0W0
	2184E0R0
	2184E0D0
	2184E0K0

6m suspension on request



custom shade and suspension  
set colour combination upon request

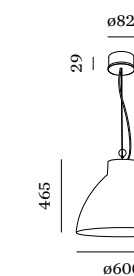

## 6.0

A60/G95 max. 25W | E27  
220-240VAC | 50-60Hz  
composite

⊕ IP20 2.62kg

CODE	
	2186E0W0
	2186E0R0
	2186E0D0
	2186E0K0

6m suspension on request



### OPTIONAL

G95 5.4W | E27 | phase-cut dim  
gold tinted

CODE	
2200K   380lm	9003E111

G95 11.2W | E27 | phase-cut dim | opal

CODE	
2700K   1100lm	9003E154

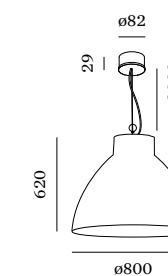

## 8.0

A60/G95 max. 25W | E27  
220-240VAC | 50-60Hz  
composite

⊕ IP20 5.70kg

CODE	
	2188E0W0
	2188E0R0
	2188E0D0
	2188E0K0

6m suspension on request

### OPTIONAL

G95 5.4W | E27 | phase-cut dim  
gold tinted

CODE	
2200K   380lm	9003E111

G95 11.2W | E27 | phase-cut dim | opal

CODE	
2700K   1100lm	9003E154



custom colour combination  
and custom track mounted

SPOT LANDING FOR YOUR FAVOURITE LIGHT

# Choose your *base*

If you have fallen in love with one of our luminaires, but need a matching ceiling rose: Then perhaps we can play matchmaker. The choice basically comes down to single or multiple pendant roses. For single pendants, they are either surface mounted, semi-recessed or invisible. The multiple pendant ceiling rose is available in a round or rectangular shape. And last but not least, there is also a wall version with an integrated light switch. Have you found your match? Then all that remains to do now is decide on a suitable lampshade and a suitable colour on the following pages.

Sie haben sich in eine unserer Leuchten verliebt und suchen jetzt nach dem passenden Baldachin? Dann spielen wir hier mal kurz die Vermittlungsbörse. Grundsätzlich können Sie zwischen Einzel- oder Multiabhängung wählen. Bei der Einzelabhängung gibt es eine Aufbau-, eine Semi-Recessed, oder eine Invisible-Variante. Den Multibaldachin gibt es in runder oder gerader Form. Und zu guter Letzt die Wandvariante mit integriertem Lichtschalter. Na, ein Match gefunden? Dann müssen Sie sich jetzt nur noch für einen passenden Lampenschirm auf den nächsten Seiten und eine passende Farbe entscheiden.



[weverducre.com/suspension-options](https://weverducre.com/suspension-options)

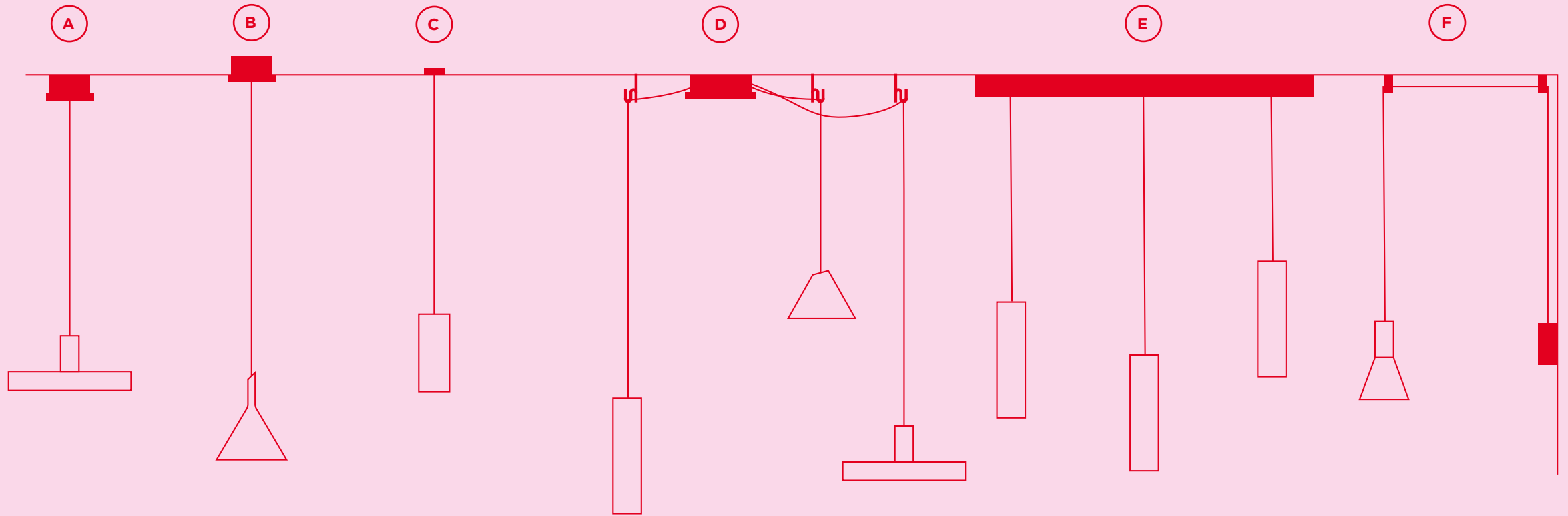

**A | SINGLE BASE**  
ceiling base round

	CODE
Light Green	90052022
Dark Grey	90052021

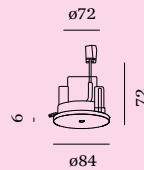

**B | SEMI RECESSED SINGLE BASE**  
for shades without steel wire only

Ⓢ 73-76 Ⓢ 70 Ⓢ 10-35

	CODE
Light Green	90052026
Dark Grey	90052027

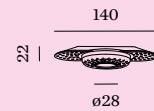

**C | INVISIBLE SINGLE BASE**  
plasterkit | system - with fixation and adjustment with or without steel cable | max. 10kg

Ⓢ 68 Ⓢ 70 Ⓢ 12.5-27.50

	CODE
Light Green	90015196
Dark Grey	90015195

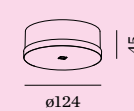

**D | MULTIPLE BASE**  
up to max. 4 | 8 luminaires

	CODE
Light Green	max. 4   90052005
Dark Grey	max. 4   90052006
Light Green	max. 8   90052031
Dark Grey	max. 8   90052032

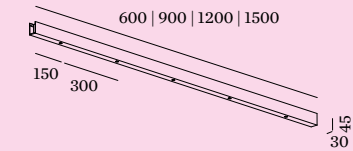

**E | LINEAR MULTIPLE BASE**  
up to max. 2 | 3 | 4 | 5 luminaires  
600mm | 900mm | 1200mm | 1500mm

	CODE
Light Green	max. 2   90052007
Dark Grey	max. 2   90052008
Light Green	max. 3   90052009
Dark Grey	max. 3   90052010
Light Green	max. 4   90052011
Dark Grey	max. 4   90052012
Light Green	max. 5   90052013
Dark Grey	max. 5   90052014

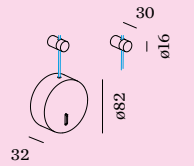

**F | WALL BASE**  
for 1 luminaire | incl. 2 wall-ceiling brackets | for cable 4.25-5.5mm diameter | incl. switch on/off

	CODE
Light Green	90019195
Dark Grey	90019196
wall - ceiling bracket	
	CODE
Light Green	90019197
Dark Grey	90019198



back



RESTAURANT GOLDMARIE | LUKAS NOBILI MAINZ GERMANY

# ODREY

Ceiling suspended

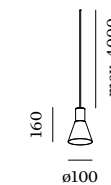
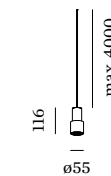

### 1.1

PAR16 max. 12W | GU10  
100-240VAC | 50-60Hz  
aluminium

IP20 0.95kg

### 1.3

PAR16 max. 12W | GU10  
100-240VAC | 50-60Hz  
aluminium

IP20 0.26kg

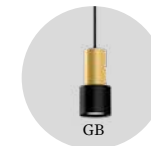

## CHOOSE YOUR BASE

A | Single base

ceiling base round | ø84

	CODE
	90052022
	90052021

B | Semi recessed single base

C | Invisible single base

D | Multiple base

E | Linear multiple base

F | Wall base

more infos on page 458

	CODE
	287120WW0
	287120GG0
	287120BB0
	287120WG0
	287120BG0
	287120GB0

## OPTIONAL

PAR16 6.5W | GU10 | phase-cut dim

	CODE
	2700K   460lm 901228W3
	2700K   437lm 901228B3
	3000K   500lm 901228W5
	3000K   457lm 901228B5

	CODE
	287320WW0
	287320GG0
	287320BB0
	287320WG0
	287320BG0
	287320GB0

## OPTIONAL

PAR16 6.5W | GU10 | phase-cut dim

	CODE
	2700K   460lm 901228W3
	2700K   437lm 901228B3
	3000K   500lm 901228W5
	3000K   457lm 901228B5

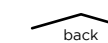





HOTEL MEERBERG PERTISAU | AUSTRIA

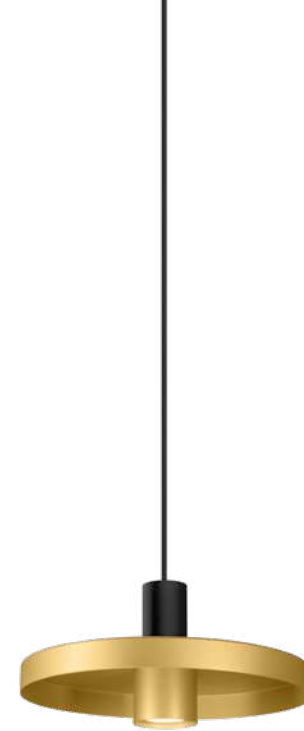

# ODREY

Ceiling suspended

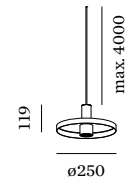

## 1.2

PAR16 max. 12W | GU10  
100-240VAC | 50-60Hz  
aluminium | shade matching  
inner cover included

IP20 0.47kg

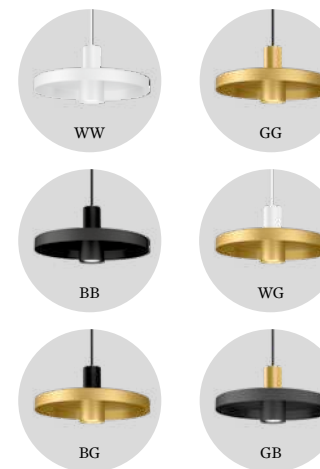

### CHOOSE YOUR BASE

**A | Single base**

ceiling base round | ø84

	CODE
	90052022
	90052021

**B | Semi recessed single base**

**C | Invisible single base**

**D | Multiple base**

**E | Linear multiple base**

**F | Wall base**

more infos on page 458

	CODE
	287220WW0
	287220GG0
	287220BB0
	287220WG0
	287220BG0
	287220GB0

### OPTIONAL

PAR16 6.5W | GU10 | phase-cut dim

	CODE
2700K   460lm	901228W3
2700K   437lm	901228B3
3000K   500lm	901228W5
3000K   457lm	901228B5



CECI PICCOLA CUCINA | STUDIOZERO85 | DANILO CASTALDI LIGHTING  
CONSULTANT PESCARA | ITALY



# ODREY

Ceiling suspended

**1.4**  
PAR16 max. 12W | GU10  
100-240VAC | 50-60Hz  
aluminium  
IP20 0.30kg

**1.5**  
PAR16 max. 12W | GU10  
100-240VAC | 50-60Hz  
aluminium  
IP20 0.90kg

**1.6**  
PAR16 max. 12W | GU10  
100-240VAC | 50-60Hz  
aluminium  
IP20 0.75kg

**CHOOSE YOUR BASE**

**A | Single base**  
ceiling base round | ø84

Color	CODE
White	90052022
Black	90052021

**B | Semi recessed single base**

**C | Invisible single base**

**D | Multiple base**

**E | Linear multiple base**

**F | Wall base**  
more infos on page 458

**OPTIONAL**  
PAR16 6.5W | GU10 | phase-cut dim

Color	CODE
White	287420WW0
Gold	287420GG0
Black	287420BB0
White/Gold	287420WG0
Black/Gold	287420BG0
Black/Gold	287420GB0

**OPTIONAL**  
PAR16 6.5W | GU10 | phase-cut dim

Color	CODE
White	287520WW0
Gold	287520GG0
Black	287520BB0
White/Gold	287520WG0
Black/Gold	287520BG0
Black/Gold	287520GB0

**OPTIONAL**  
PAR16 6.5W | GU10 | phase-cut dim

Color	CODE
White	287620WW0
Gold	287620GG0
Black	287620BB0
White/Gold	287620WG0
Black/Gold	287620BG0
Black/Gold	287620GB0

optional inner cover on page 755

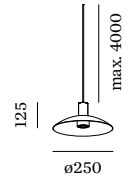
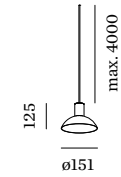

1.7

PAR16 max. 12W | GU10  
100-240VAC | 50-60Hz  
aluminium

IP20 0.30kg

1.8

PAR16 max. 12W | GU10  
100-240VAC | 50-60Hz  
aluminium | shade matching  
inner cover included

IP20 0.41kg



WW



GG



BB



WG



BG



GB

CHOOSE YOUR BASE

A | Single base

ceiling base round | ø84

	CODE
	90052022
	90052021

B | Semi recessed single base

C | Invisible single base

D | Multiple base

E | Linear multiple base

F | Wall base

more infos on page 458

	CODE
	287720WW0
	287720GG0
	287720BB0
	287720WG0
	287720BG0
	287720GB0

optional inner cover on page 755

OPTIONAL

PAR16 6.5W | GU10 | phase-cut dim

	CODE
2700K   460lm	901228W3
2700K   437lm	901228B3
3000K   500lm	901228W5
3000K   457lm	901228B5

	CODE
	287820WW0
	287820GG0
	287820BB0
	287820WG0
	287820BG0
	287820GB0

OPTIONAL

PAR16 6.5W | GU10 | phase-cut dim

	CODE
2700K   460lm	901228W3
2700K   437lm	901228B3
3000K   500lm	901228W5
3000K   457lm	901228B5



# RAY

Ceiling suspended

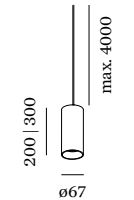
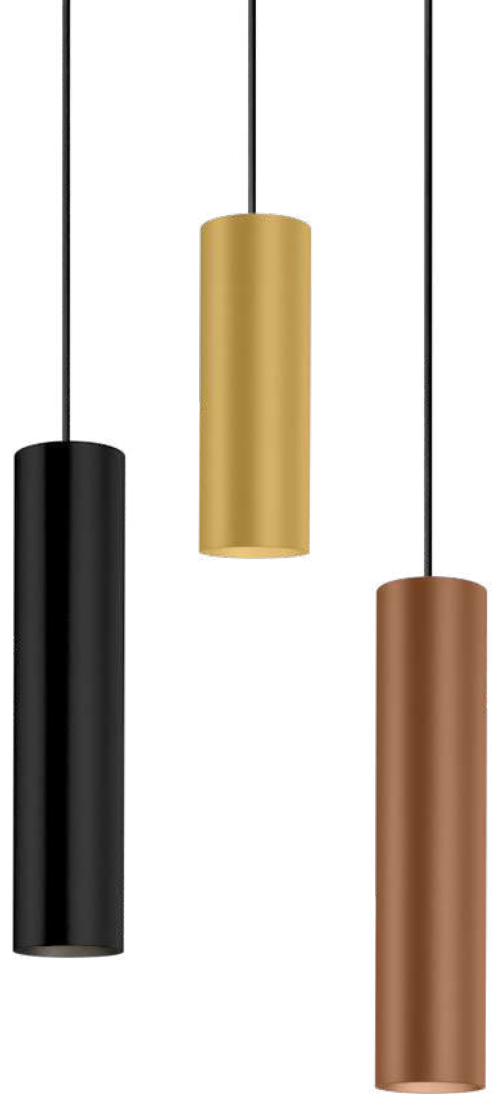
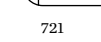

### 2.0 | 3.0 LED

LED COB 6W | phase-cut dim  
220-240VAC | 50-60Hz | incl. driver  
aluminium

IP20 - A - 36° SDCM2 180/55K 0.62/0.76kg

### 2.0

200mm

	CODE
	226764W_
	226764L_
	226764G_
	226764M_
	226764P_
	226764B_

### 3.0

300mm

	CODE
	226864W_
	226864L_
	226864G_
	226864M_
	226864P_
	226864B_

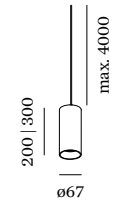

### 2.0 | 3.0 PAR16

PAR16 max. 12W | GU10  
100-240VAC | 50-60Hz  
aluminium

IP20 0.54/0.68kg

### 2.0

200mm

	CODE
	227720W0
	227720L0
	227720G0
	227720M0
	227720P0
	227720B0

### 3.0

300mm

	CODE
	227820W0
	227820L0
	227820G0
	227820M0
	227820P0
	227820B0

### CHOOSE YOUR BASE

#### A | Single base

ceiling base round | ø84

	CODE
	90052022
	90052021

#### B | Semi recessed single base

#### C | Invisible single base

#### D | Multiple base

#### E | Linear multiple base

#### F | Wall base

more infos on page 458

LIGHT COLOUR	LUMEN   CRI	CODE
2700K	405   >90	3
3000K	430   >90	5
2000-3000K   9W	570   >90	9

white fixtures with white cable  
other fixtures with black cable  
more colour combinations on request

### OPTIONAL

PAR16 6.5W | GU10 | phase-cut dim

	CODE
2700K   460lm	901228W3
2700K   437lm	901228B3
3000K   500lm	901228W5
3000K   457lm	901228B5

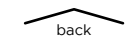



# HEXO

Ceiling suspended



181



315 | 343 | 355

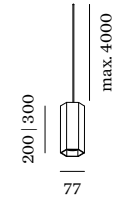

## 2.0 | 3.0 LED

LED COB 6W | phase-cut dim  
220-240VAC | 50-60Hz | incl. driver  
aluminium

IP20  $\Delta$  36° SDCM2 L80|55K 0.66|0.82kg

### 2.0

200mm	CODE
	226364G_
	226364Q_
	226364P_
	226364B_

### 3.0

300mm	CODE
	226464G_
	226464Q_
	226464P_
	226464B_

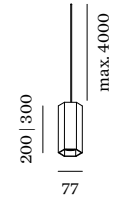

## 2.0 | 3.0 PAR16

PAR16 max. 12W | GU10  
100-240VAC | 50-60Hz  
aluminium

IP20 0.58|0.74kg

### 2.0

200mm	CODE
	227320G0
	227320Q0
	227320P0
	227320B0

### 3.0

300mm	CODE
	227420G0
	227420Q0
	227420P0
	227420B0

## CHOOSE YOUR BASE

### A | Single base

ceiling base round |  $\varnothing$ 84

CODE	
	90052022
	90052021

### B | Semi recessed single base

### C | Invisible single base

### D | Multiple base

### E | Linear multiple base

### F | Wall base

more infos on page 458

LIGHT COLOUR	LUMEN CRI	CODE
2700K	420 >90	3
3000K	440 >90	5
2000-3000K   9W	570 >90	9

white fixtures with white cable  
other fixtures with black cable  
more colour combinations on request

## OPTIONAL

PAR16 6.5W | GU10 | phase-cut dim

CODE	
2700K   460lm	901228W3
2700K   437lm	901228B3
3000K   500lm	901228W5
3000K   457lm	901228B5

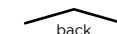





# WETRO

Ceiling suspended



As awarded by The Chicago Athenaeum: Museum of Architecture and Design

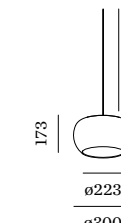
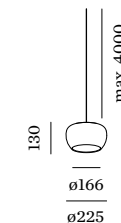
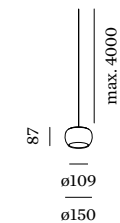

## CHOOSE YOUR BASE

### A | Single base

ceiling base round | ø84

	CODE
	90052022
	90052021

### B | Semi recessed single base

### C | Invisible single base

### D | Multiple base

### E | Linear multiple base

### F | Wall base

more infos on page 458

all fixtures with black cable  
white cable on request

### 1.0

LED PCB 12W | phase-cut dim  
220-240VAC | 50-60Hz  
artisanal hand blown glass

IP20 SDCM3 L80|50K 0.56kg

1800-2850K | CRI >90 | 375lm

	CODE
	236188P9

1800-2850K | >90 CRI | 525lm

	CODE
	236188B9

### 2.0

LED PCB 12W | phase-cut dim  
220-240VAC | 50-60Hz  
artisanal hand blown glass

IP20 SDCM3 L80|50K 0.97kg

1800-2850K | CRI >90 | 385lm

	CODE
	236288P9

1800-2850K | >90 CRI | 510lm

	CODE
	236288B9

### 3.0

LED PCB 12W | phase-cut dim  
220-240VAC | 50-60Hz  
artisanal hand blown glass

IP20 SDCM3 L80|50K 1.69kg

1800-2850K | CRI >90 | 445lm

	CODE
	236388P9

1800-2850K | >90 CRI | 530lm

	CODE
	236388B9

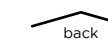







# WETRO

Ceiling suspended

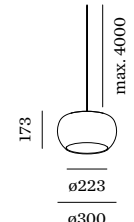
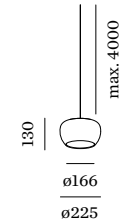
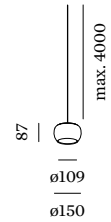

## CHOOSE YOUR BASE

### A | Single base

ceiling base round |  $\varnothing 84$

CODE  
 90052022  
 90052021

### B | Semi recessed single base

### C | Invisible single base

### D | Multiple base

### E | Linear multiple base

### F | Wall base

more infos on page 458

all fixtures with black cable  
 white cable on request

### 1.0

LED PCB 12W | phase-cut dim  
 220-240VAC | 50-60Hz  
 artisanal Italian hand blown glass

IP20 SDCM3 L80|50K 0.56kg

1800-2850K | CRI >90 | 615lm

CODE  
 236188TS9

1800-2850K | CRI >90 | 520lm

CODE  
 236188TD9

### 2.0

LED PCB 12W | phase-cut dim  
 220-240VAC | 50-60Hz  
 artisanal Italian hand blown glass

IP20 SDCM3 L80|50K 0.97kg

1800-2850K | CRI >90 | 510lm

CODE  
 236288TS9

1800-2850K | CRI >90 | 480lm

CODE  
 236288TD9

### 3.0

LED PCB 12W | phase-cut dim  
 220-240VAC | 50-60Hz  
 artisanal Italian hand blown glass

IP20 SDCM3 L80|50K 1.69kg

1800-2850K | CRI >90 | 530lm

CODE  
 236388TS9

1800-2850K | CRI >90 | 500lm

CODE  
 236388TD9



# WETRO

Ceiling suspended

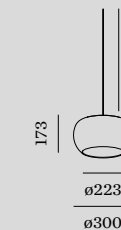
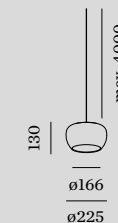

## CHOOSE YOUR BASE

### A | Single base

ceiling base round | ø84

	CODE
	90052022
	90052021

- B | Semi recessed single base
- C | Invisible single base
- D | Multiple base
- E | Linear multiple base
- F | Wall base

more infos on page 458

all fixtures with black cable  
white cable on request

### 1.0

LED PCB 12W | phase-cut dim  
220-240VAC | 50-60Hz  
artisanal Italian hand blown glass

IP20 SDCM3 L80|50K 0.56kg

1800-2850K | CRI >90 | 500lm

	CODE
	236188TW9

1800-2850K | CRI >90 | 460lm

	CODE
	236188DW9

### 2.0

LED PCB 12W | phase-cut dim  
220-240VAC | 50-60Hz  
artisanal Italian hand blown glass

IP20 SDCM3 L80|50K 0.97kg

1800-2850K | CRI >90 | 430lm

	CODE
	236288TW9

1800-2850K | CRI >90 | 420lm

	CODE
	236288DW9

### 3.0

LED PCB 12W | phase-cut dim  
220-240VAC | 50-60Hz  
artisanal Italian hand blown glass

IP20 SDCM3 L80|50K 1.69kg

1800-2850K | CRI >90 | 470lm

	CODE
	236388TW9

1800-2850K | CRI >90 | 440lm

	CODE
	236388DW9

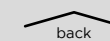



# CLEA

Ceiling suspended

new

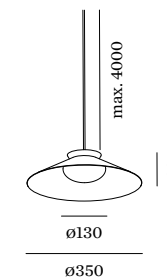

1.0

LED COB 15W | phase-cut dim  
220-240VAC | 50-60Hz | incl. driver  
aluminium  
white opal glass hand blown

⊕ IP20 SDCM2 L80I50K 0.80kg

CODE  
90052022

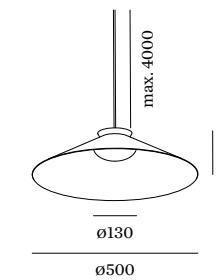

2.0

LED COB 15W | phase-cut dim  
220-240VAC | 50-60Hz | incl. driver  
aluminium  
white opal glass hand blown

⊕ IP20 SDCM2 L80I50K 1.34kg

CODE  
281884W\_

281884SG\_  
281884FJ\_

LIGHT COLOUR	LUMEN	CRI	CODE
2700K	710	>90	3
3000K	760	>90	5

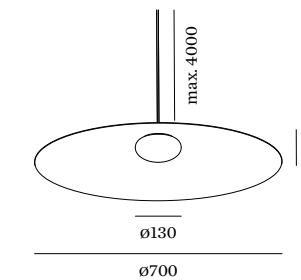

3.0

LED COB 15W | phase-cut dim  
220-240VAC | 50-60Hz | incl. driver  
aluminium  
white opal glass hand blown

⊕ IP20 SDCM2 L80I50K 2.14kg

CODE  
281984W\_

281984SG\_  
281984FJ\_

LIGHT COLOUR	LUMEN	CRI	CODE
2700K	710	>90	3
3000K	760	>90	5

## CHOOSE YOUR BASE

**A | Single base**

ceiling base round | ø84

CODE  
90052022

**B | Semi recessed single base**

**C | Invisible single base**

**D | Multiple base**

more infos on page 458

all fixtures with white cable  
black cable on request

Rev. 001/2024-05

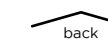



# SHIEK

Ceiling suspended



## CHOOSE YOUR BASE

### A | Single base

ceiling base round | ø84

CODE
90052022
90052021

### B | Semi recessed single base

### C | Invisible single base

### D | Multiple base

### E | Linear multiple base

### F | Wall base

more infos on page 458

all fixtures with black cable  
white cable on request

## 1.0 LED

LED PCB 12W | phase-cut dim  
220-240VAC | 50-60Hz  
aluminium

IP20 SDCM3 L80|50K 0.36kg

1800-2850K | CRI >90 | 525lm

CODE
237188W9
237188J9
237188P9
237188K9
237188Z9

## 2.0 LED

LED PCB 12W | phase-cut dim  
220-240VAC | 50-60Hz  
aluminium

IP20 SDCM3 L80|50K 0.47kg

1800-2850K | CRI >90 | 525lm

CODE
237288W9
237288J9
237288P9
237288K9
237288Z9

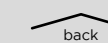



# SHIEK

Ceiling suspended



reddot award 2017  
winner



DESIGN  
AWARD  
2017



As awarded by The Chicago Athenaeum:  
Museum of Architecture and Design

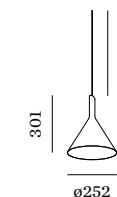

## 3.0 LED

LED LED PCB 12W | phase-cut dim  
220-240VAC | 50-60Hz  
aluminium

IP20 SDCM3 L80I50K 0.60kg

## CHOOSE YOUR BASE

### A | Single base

ceiling base round | ø84

CODE	Color swatch
90052022	[White swatch]
90052021	[Black swatch]

### B | Semi recessed single base

### C | Invisible single base

### D | Multiple base

### E | Linear multiple base

### F | Wall base

more infos on page 458

1800-2850K | CRI >90 | 525lm

CODE	Color swatch
237388W9	[White swatch]
237388J9	[Yellow swatch]
237388P9	[Orange swatch]
237388K9	[Black swatch]
237388Z9	[Brown swatch]

all fixtures with black cable  
white cable on request

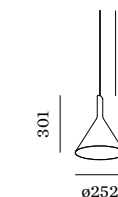

## 3.0 E27

A60 max. 20W | E27  
100-240VAC | 50-60Hz  
aluminium

IP20 0.60kg

CODE	Color swatch
2343E0W0	[White swatch]
2343E0J0	[Yellow swatch]
2343E0P0	[Orange swatch]
2343E0K0	[Black swatch]
2343E0Z0	[Brown swatch]

## OPTIONAL

A60 9W opal | E27 | phase-cut dim

CODE	Color swatch
9003E152	[White swatch]

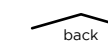



# SHIEK

Ceiling suspended

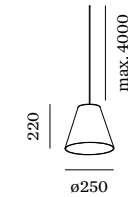

## 4.0 LED

LED PCB 12W | phase-cut dim  
220-240VAC | 50-60Hz  
aluminium

IP20 SDCM3 L80I50K 0.70kg

1800-2850K | CRI >90 | 525lm

### CHOOSE YOUR BASE

#### A | Single base

ceiling base round | ø84

CODE	Color
90052022	White
90052021	Black

#### B | Semi recessed single base

#### C | Invisible single base

#### D | Multiple base

#### E | Linear multiple base

#### F | Wall base

more infos on page 458

all fixtures with black cable  
white cable on request

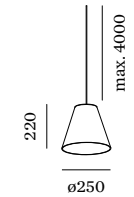

## 4.0 E27

A60 max. 20W | E27  
100-240VAC | 50-60Hz  
aluminium

IP20 0.70kg

CODE	Color
2344E0W0	White
2344E0J0	Yellow
2344E0P0	Orange
2344E0K0	Black
2344E0Z0	Grey

### OPTIONAL

A60 9W opal | E27 | phase-cut dim

CODE	Color
9003E152	White

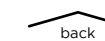

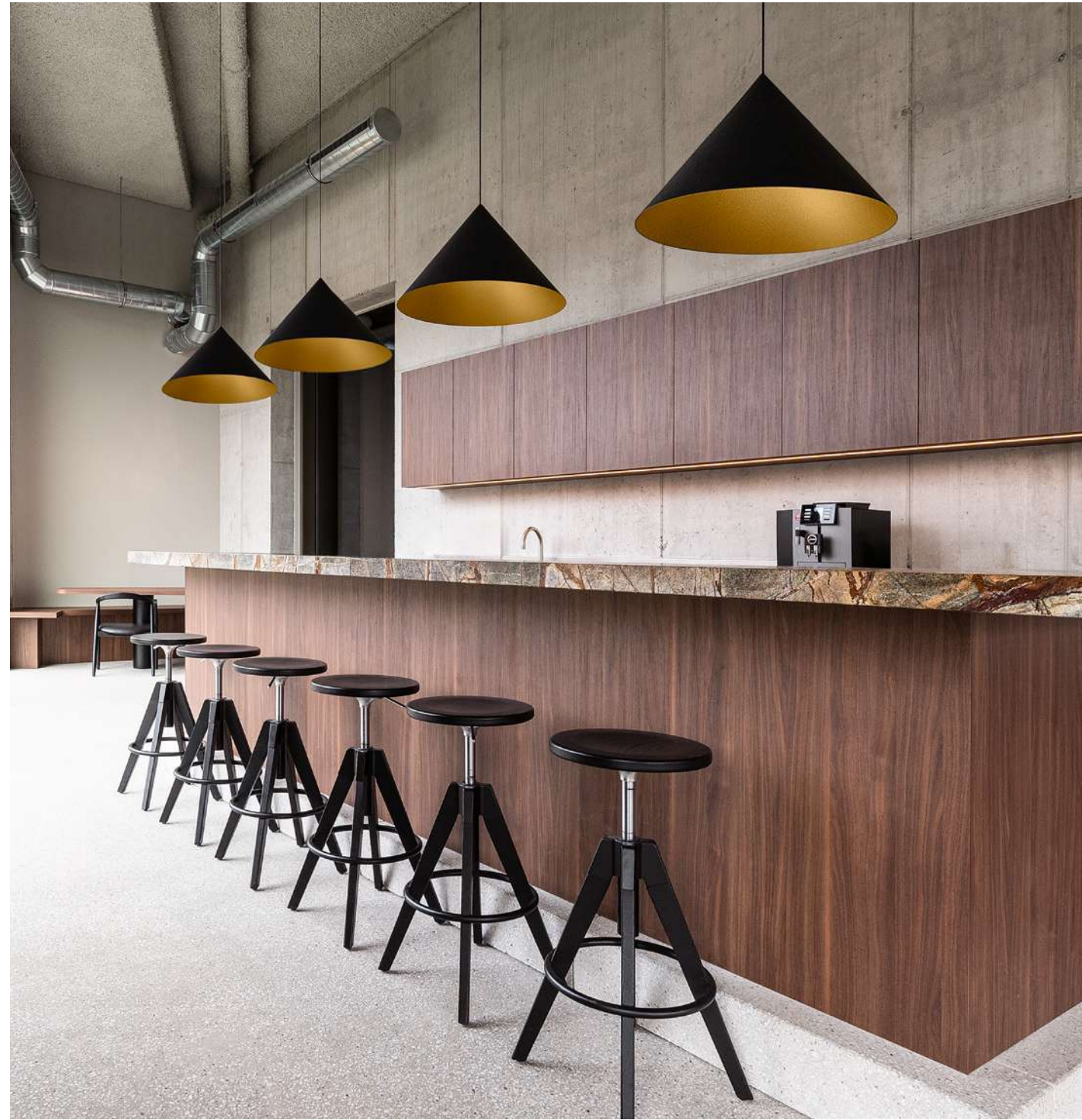

LINK LAB CREATIVE OFFICES | STAY STUDIO KORTRIJK | BELGIUM

# DINOR

Ceiling suspended

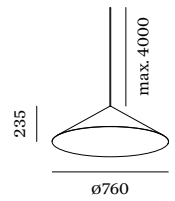
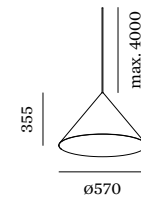
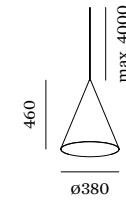

## CHOOSE YOUR BASE

### A | Single base

ceiling base round | ø84

CODE	
	90052022
	90052021

### B | Semi recessed single base

### C | Invisible single base

more infos on page 458

all fixtures with black cable  
white cable on request

Rev. 001/2024-05  
3H DRAFT

## 1.0

LED PCB 12W | phase-cut dim  
220-240VAC | 50-60Hz  
aluminium

IP20 SDCM3 L80|60K 0.90kg

1800-2850K | CRI >90 | 570lm

CODE	
	255188GW9
	255188BG9
	255188BB9

## 2.0

LED PCB 12W | phase-cut dim  
220-240VAC | 50-60Hz  
aluminium

IP20 SDCM3 L80|60K 1.30kg

1800-2850K | CRI >90 | 750lm

CODE	
	255288GW9
	255288BG9
	255288BB9

## 3.0

LED PCB 12W | phase-cut dim  
220-240VAC | 50-60Hz  
aluminium

IP20 SDCM3 L80|60K 2.30kg

1800-2850K | CRI >90 | 830lm

CODE	
	255388GW9
	255388BG9
	255388BB9

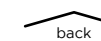

back





RESTAURANT VINA | INNOCAD ARCHITECTURE GRAZ | AUSTRIA



## RECESSED



**RETO 0.8**  
499



**RETO 2.0**  
499



**LITO 1.0**  
501



**LITO 2.0**  
501



**STRIPE**  
503



**STRANGE  
TRIMLESS**  
505



**THEMIS**  
507



**ORIS 0.7**  
509



**ORIS 0.8**  
509



**ORIS 1.3**  
509



# RETO

Wall recessed

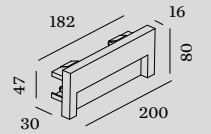
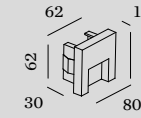

## 0.8

LED PCB 3W | 350mA | 9V  
aluminium

IP20 SDCM3 L80|50K 0.27kg

66x66 | 40 | min. 12

3000K | CRI >90 | 150lm

CODE
3451A1W5
3451A1L5
3451A1M5
3451A1Q5
3451A1B5

## 2.0

LED PCB 6W | 350mA | 17V  
aluminium

IP20 SDCM3 L80|50K 0.41kg

47x182 | 40 | min. 12

3000K | CRI >90 | 455lm

CODE
3452A1W5
3452A1B5

## ALWAYS USE

driver | 350mA

CODE
90213202

6W

more options and specs on page 806

## OPTIONAL

recessed housing incl. plasterkit

CODE
90012047

concrete housing

CODE
90012046

specs on page 818

## ALWAYS USE

driver | 350mA

CODE
90213202

6W

more options and specs on page 806

## OPTIONAL

recessed housing incl. plasterkit

CODE
90012039

concrete housing

CODE
90012044

specs on page 818

Rev. 001/2024-05

back



703



739



# LITO

Wall recessed

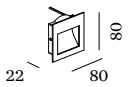
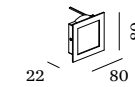

## 1.0

LED PCB 2/3W | 350/500mA | 6V aluminium | anod.

IP20 SDCM3 L80|60K 0.09kg

70x70 | 35 min. 12

3000K | CRI >90 | 145/200lm

	CODE
	145381W5
	145381A5
	145381B5

## ALWAYS USE

driver

	CODE
6W   350mA	90213202
6W   500mA	90214201

more options and specs on page 806

## OPTIONAL

	CODE
recessed housing	90012027
plasterkit	90017119

recessed housing | always use in combination with plasterkit

## 2.0

LED PCB 2/3W | 350/500mA | 6V aluminium | anod.

IP20 SDCM3 L80|60K 0.09kg

70x70 | 35 min. 12

3000K | CRI >90 | 90/120lm

	CODE
	1454A1W5
	1454A1A5
	1454A1B5

## ALWAYS USE

driver

	CODE
6W   350mA	90213202
6W   500mA	90214201

more options and specs on page 806

## OPTIONAL

	CODE
recessed housing	90012027
plasterkit	90017119

recessed housing | always use in combination with plasterkit

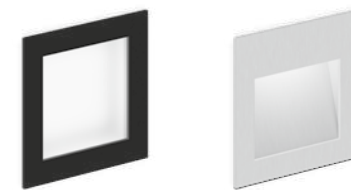



# STRIPE

Wall recessed

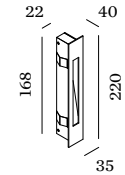
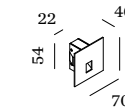
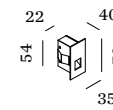





## 0.4

LED PCB 1/2W | 350/700mA | 3V aluminium

IP20 SDCM3 L70|60K 0.09kg

25x56 40 8-18

3000K | CRI >80 | 15/28lm

CODE	
	3054A1W4
	3054A1L4
	3054A1G4
	3054A1B4

## ALWAYS USE

driver

CODE	
6W   350mA	90213202
6W   700mA	90215203

more options and specs on page 806

## OPTIONAL

recessed housing incl. plasterkit

CODE	
	90012037

specs on page 818





## 0.7

LED PCB 1/2W | 350/700mA | 3V aluminium

IP20 SDCM3 L70|60K 0.10kg

25x56 40 8-18

3000K | CRI >80 | 15/28lm

CODE	
	3055A1W4
	3055A1L4
	3055A1G4
	3055A1B4

## ALWAYS USE

driver

CODE	
6W   350mA	90213202
6W   700mA	90215203

more options and specs on page 806

## OPTIONAL

recessed housing incl. plasterkit

CODE	
	90012037

specs on page 818





## 2.2

LED PCB 1/2W | 350/700mA | 3V aluminium

IP20 SDCM3 L70|60K 0.27kg

25x170 40 8-18

3000K | CRI >80 | 20/36lm

CODE	
	3056A1W4
	3056A1L4
	3056A1G4
	3056A1B4

## ALWAYS USE

driver

CODE	
6W   350mA	90213202
6W   700mA	90215203

more options and specs on page 806

## OPTIONAL

recessed housing incl. plasterkit

CODE	
	90012038

specs on page 818





# STRANGE trimless

Wall recessed

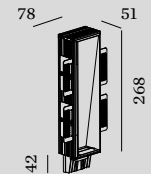
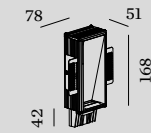

## 1.7

LED PCB 3/5W | 500/700mA | 6V  
aluminium | incl. plasterkit

IP20 SDCM3 L80|60K 0.24kg

170x86 11.55 2-25

CODE

3207A1W\_

LIGHT COLOUR	LUMEN CRI	CODE
2700K	240/320 >80	2
3000K	260/350 >80	4

## ALWAYS USE

driver

CODE

6W   500mA	90214201
6W   700mA	90215203

more options and specs on page 808

## 2.7

LED PCB 3/5W | 500/700mA | 6V  
aluminium | incl. plasterkit

IP20 SDCM3 L80|60K 0.31kg

270x86 11.55 2-25

CODE

3208A1W\_

LIGHT COLOUR	LUMEN CRI	CODE
2700K	240/320 >80	2
3000K	260/350 >80	4

## ALWAYS USE

driver

CODE

6W   500mA	90214201
6W   700mA	90215203

more options and specs on page 808



SHOWROOM GRANDO KEUKENS BRUGES | BELGIUM



# THEMIS

Wall recessed

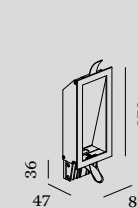

## 1.7

LED PCB 3/5W | 500/700mA | 6V aluminium

IP20 SDCM3 L80|60K 0.24kg

70x158 50 2-18

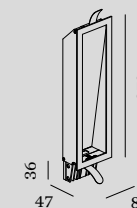

## 2.7

LED PCB 3/5W | 500/700mA | 6V aluminium

IP20 SDCM3 L80|60K 0.31kg

70x258 50 2-18

CODE	
	3237AIW_
	3237AIK_

LIGHT COLOUR	LUMEN CRI	CODE
2700K	240/320 >80	2
3000K	260/350 >80	4

### ALWAYS USE

driver

CODE	
6W   500mA	90214201
6W   700mA	90215203

more options and specs on page 808

### OPTIONAL

CODE	
recessed housing	90012032
plasterkit	90017111

recessed housing | always use in combination with plasterkit

CODE	
	3238AIW_
	3238AIK_

LIGHT COLOUR	LUMEN CRI	CODE
2700K	240/320 >80	2
3000K	260/350 >80	4

### ALWAYS USE

driver

CODE	
6W   500mA	90214201
6W   700mA	90215203

more options and specs on page 808

### OPTIONAL

CODE	
recessed housing	90012033
plasterkit	90017112

recessed housing | always use in combination with plasterkit

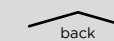

back



# ORIS

Wall recessed

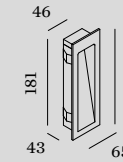

## 0.7

LED PCB 2/5W | 350/700mA | 6V aluminium

IP20 SDCM3 L70|60K 0.28kg

47x182 40 min. 12

3000K | CRI >90 | 70/115lm

	CODE
	3271A1W5
	3271A1B5

### ALWAYS USE

driver

	CODE
6W   350mA	90213202
6W   700mA	90215203

more options and specs on page 806

### OPTIONAL

recessed housing incl. plasterkit

	CODE
	90012039

concrete housing

	CODE
	90012044

specs on page 818

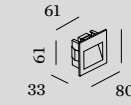

## 0.8

LED PCB 2/5W | 350/700mA | 6V aluminium

IP20 SDCM3 L70|60K 0.15kg

66x66 40 min. 12

3000K | CRI >90 | 90/140lm

	CODE
	3274A1W5
	3274A1B5

### ALWAYS USE

driver

	CODE
6W   350mA	90213202
6W   700mA	90215203

more options and specs on page 806

### OPTIONAL

recessed housing incl. plasterkit

	CODE
	90012047

concrete housing

	CODE
	90012046

specs on page 818

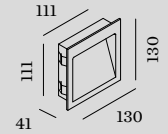

## 1.3

LED PCB 3/7W | 350/700mA | 9V aluminium

IP20 SDCM3 L70|60K 0.34kg

115x117 40 min. 12

3000K | CRI >90 | 140/220lm

	CODE
	3276A1W5
	3276A1B5

### ALWAYS USE

driver

	CODE
6W   350mA	90213202
7W   700mA	90215301

more options and specs on page 806

### OPTIONAL

recessed housing incl. plasterkit

	CODE
	90012041

concrete housing

	CODE
	90012040

specs on page 818





## LUMINAIRES

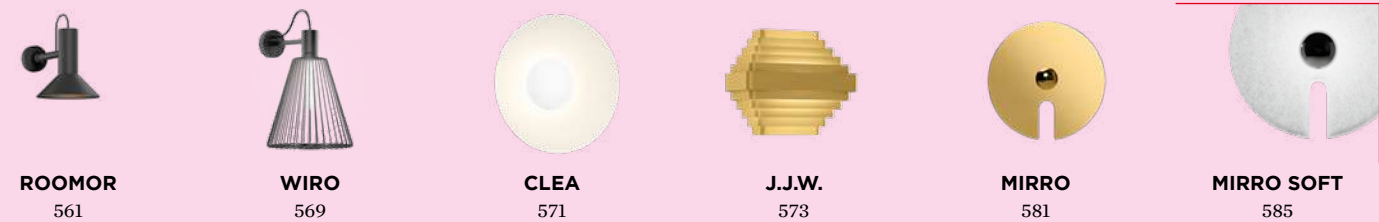

## SPOTLIGHTS

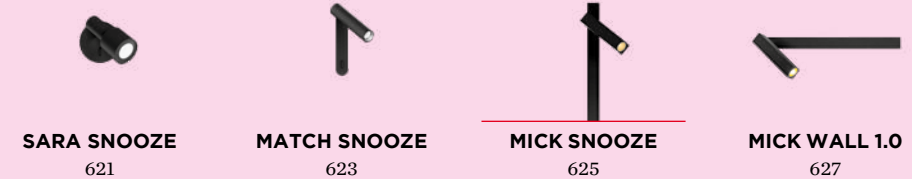
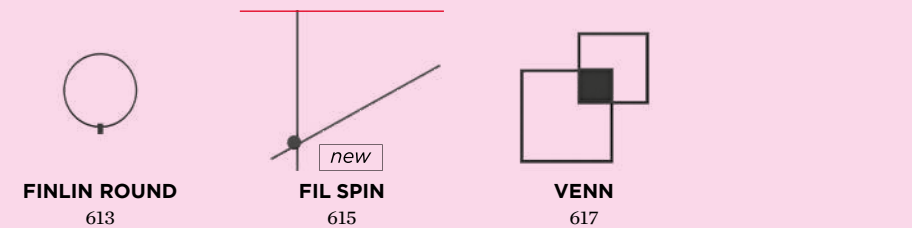

## UPLIGHTS



## IP-RATED





# CENO

Wall surface



303 | 353

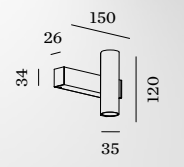
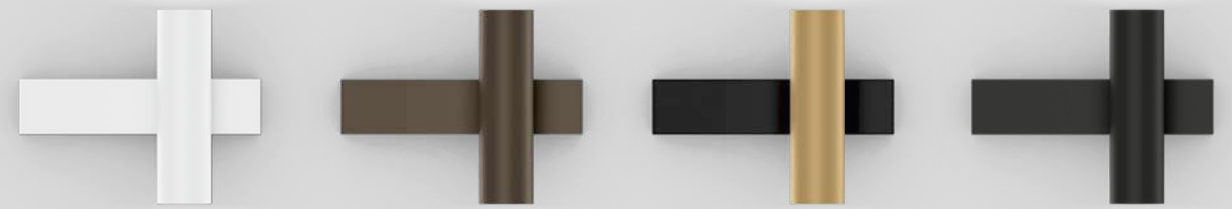

## 2.0

LED COB 8W | phase-cut dim  
220-240VAC | 50-60Hz | incl. driver  
aluminium

IP20 ⚡ 31° SDCM2 L70|55K 0.28kg

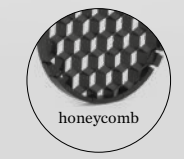

### OPTIONAL

honeycomb louvers



CODE
376264W_
376264Q_
376264CH_
376264B_

LIGHT COLOUR	LUMEN CRI	CODE
2700K	2x280 >90	3
3000K	2x300 >90	5

CODE
90051131

back



# MATCH

Wall surface



reddot winner 2023



DESIGN AWARD 2023



As awarded by The Chicago Athenaeum: Museum of Architecture and Design

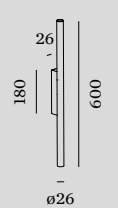

## 2.0

LED COB 12W | phase-cut dim  
220-240VAC | 50-60Hz | incl. driver  
aluminium

IP20 23° SDCM2 L80|50K 0.41kg

	CODE
	377264W_
	377264BL_
	377264B_

LIGHT COLOUR	LUMEN CRI	CODE
2700K	2x380 >90	3
3000K	2x410 >90	5

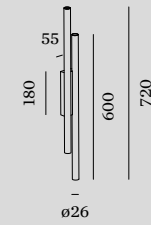

## 4.0

LED COB 23W | phase-cut dim  
220-240VAC | 50-60Hz | incl. driver  
aluminium

IP20 23° SDCM2 L80|50K 0.76kg

	CODE
	377464W_
	377464B_

LIGHT COLOUR	LUMEN CRI	CODE
2700K	4x380 >90	3
3000K	4x410 >90	5

back



# TRACE

Wall surface



reddot winner 2023



201 | 253 | 257



373 | 399

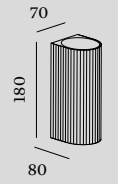
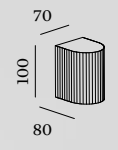
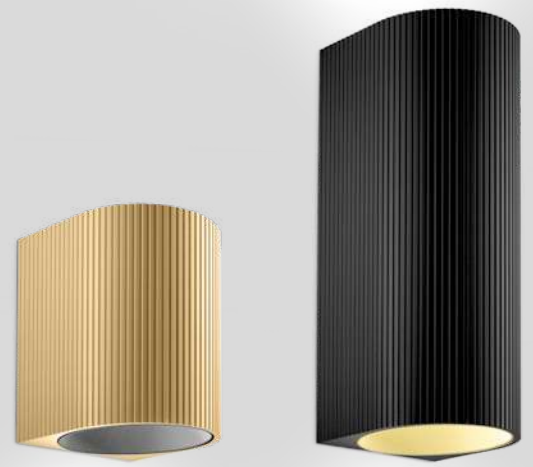

## 1.0

LED COB 8W | phase-cut dim  
220-240VAC | 50-60Hz | incl. driver  
aluminium

IP20 22° SDCM2 L80|50K 0.42kg

## 2.0

LED COB 15W | phase-cut dim  
220-240VAC | 50-60Hz | incl. driver  
aluminium

IP20 22° SDCM2 L80|50K 0.74kg

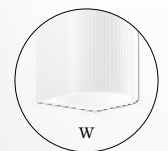

CODE			
	333164W_		
	333164H_		
	333164CH_		
	333164B_		

LIGHT COLOUR	LUMEN CRI	CODE
2700K	560 >90	3
3000K	630 >90	5

CODE			
	333264W_		
	333264H_		
	333264CH_		
	333264B_		

LIGHT COLOUR	LUMEN CRI	CODE
2700K	2x560 >90	3
3000K	2x630 >90	5

back





# TRACE SLIM

Wall surface



reddot winner 2023



201 | 253 | 257



373 | 399

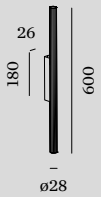
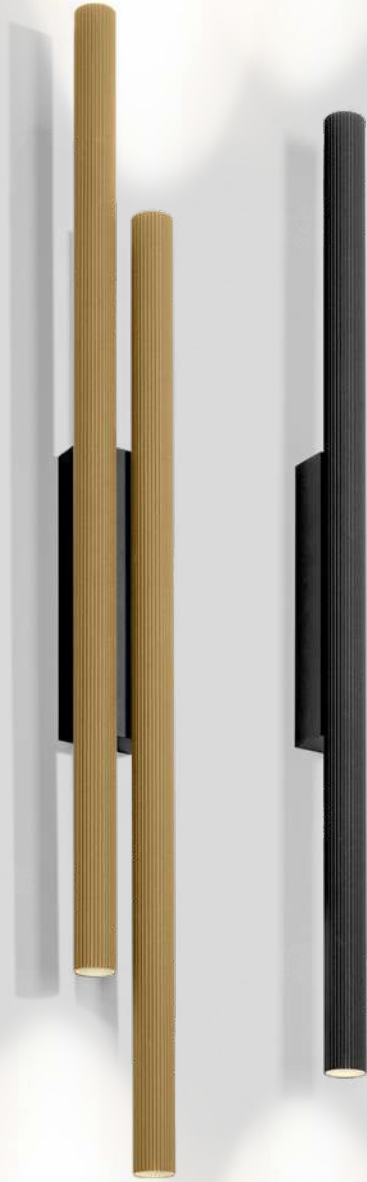

## 1.0

LED COB 12W | phase-cut dim  
220-240VAC | 50-60Hz | incl. driver  
aluminium

IP20 23° SDCM2 L80|50K 0.49kg

CODE	
	333364CH_
	333364B_

LIGHT COLOUR	LUMEN CRI	CODE
2700K	2x380 >90	3
3000K	2x410 >90	5

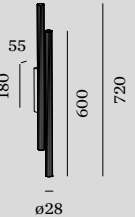

## 2.0

LED COB 23W | phase-cut dim  
220-240VAC | 50-60Hz | incl. driver  
aluminium

IP20 23° SDCM2 L80|50K 0.96kg

CODE	
	333464CH_
	333464B_

LIGHT COLOUR	LUMEN CRI	CODE
2700K	4x380 >90	3
3000K	4x410 >90	5

back



weverducre.com/odrey



#### ODREY ON THE WALL

## She lights up every room

She exudes the elegance of the 50s like no other. And can change its look faster than any movie star. Who are we talking about? ODREY, of course. She looks stunning in almost any colour combination. And she is highly flexible in terms of the shape of the shade. There are three different shades to choose from, available in black or gold. They can be combined with two mounts in black or gold to create an ever-changing luminaire. ODREY can emit light either upwards, downwards, or in both directions, which is especially lovely. So corridors or restaurant walls can be accentuated with the utmost flair.

Sie versprüht die Eleganz der 50er wie keine andere. Und kann ihren Look schneller wechseln als jeder Filmstar. Von wem hier die Rede ist? Natürlich von ODREY, die in nahezu jeder Farbkombination umwerfend aussieht. Und sich auch in puncto Schirmform höchst flexibel zeigt. Zur Auswahl stehen drei verschiedene Shades, die in Schwarz oder Gold zu haben sind. Sie können mit je zwei Mountings in Schwarz oder Gold kombiniert werden und ergeben so immer wieder eine neue Leuchte. Besonders schön: ODREY kann das Licht entweder nach oben, nach unten oder in beide Richtungen abgeben. So können Flure oder Restaurantwände gekonnt akzentuiert werden.

# Choose your very own *ODREY*.

#### MOUNTING + SHADES

##### MOUNTING

available in ● white, ● gold or ● black

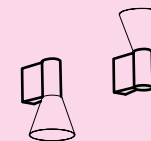

direct light



direct | indirect light



##### SHADES

available in ● white, ● gold or ● black



ø 100



ø 124



ø 115



ø 100



ø 124



ø 115



back



# ODREY

Wall surface



As awarded by The Chicago Athenaeum:  
Museum of Architecture and Design



323



461

511

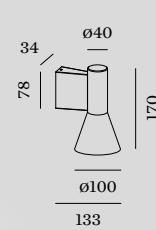

## 1.3

PAR16 max. 12W | GU10  
100-240VAC | 50-60Hz  
aluminium | steel

IP20 0.80kg

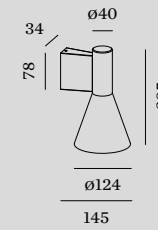

## 1.4

PAR16 max. 12W | GU10  
100-240VAC | 50-60Hz  
aluminium | steel

IP20 0.34kg

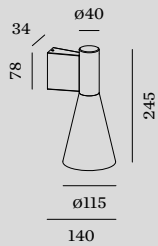

## 1.5

PAR16 max. 12W | GU10  
100-240VAC | 50-60Hz  
aluminium | steel

IP20 0.36kg



WW



GG



BB



GW

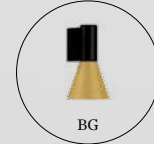

BG

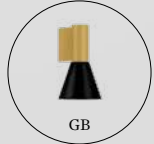

GB

CODE	
	387120WW0
	387120GG0
	387120BB0
	387120GW0
	387120BG0
	387120GB0

### OPTIONAL

PAR16 6.5W | GU10 | phase-cut dim

CODE		
	2700K   460lm	901228W3
	2700K   437lm	901228B3
	3000K   500lm	901228W5
	3000K   457lm	901228B5

CODE	
	387220WW0
	387220GG0
	387220BB0
	387220GW0
	387220BG0
	387220GB0

### OPTIONAL

PAR16 6.5W | GU10 | phase-cut dim

CODE		
	2700K   460lm	901228W3
	2700K   437lm	901228B3
	3000K   500lm	901228W5
	3000K   457lm	901228B5

CODE	
	387320WW0
	387320GG0
	387320BB0
	387320GW0
	387320BG0
	387320GB0

### OPTIONAL

PAR16 6.5W | GU10 | phase-cut dim

CODE		
	2700K   460lm	901228W3
	2700K   437lm	901228B3
	3000K   500lm	901228W5
	3000K   457lm	901228B5

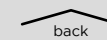

back





# ODREY

Wall surface



As awarded by The Chicago Athenaeum: Museum of Architecture and Design

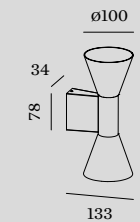

## 2.3

2x PAR16 max. 12W | GU10  
100-240VAC | 50-60Hz  
aluminium | steel

IP20 0.41kg

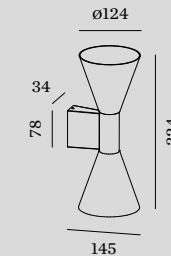

## 2.4

2x PAR16 max. 12W | GU10  
100-240VAC | 50-60Hz  
aluminium | steel

IP20 0.50kg

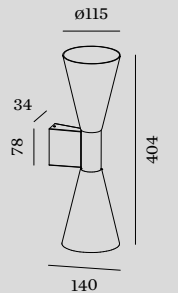

## 2.5

2x PAR16 max. 12W | GU10  
100-240VAC | 50-60Hz  
aluminium | steel

IP20 0.54kg

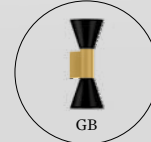
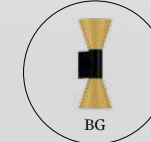

CODE	
387420WW0	387420GG0
387420BB0	387420GW0
387420BG0	387420GB0

### OPTIONAL

PAR16 6.5W | GU10 | phase-cut dim

CODE	
2700K   460lm	901228W3
2700K   437lm	901228B3
3000K   500lm	901228W5
3000K   457lm	901228B5

CODE	
387520WW0	387520GG0
387520BB0	387520GW0
387520BG0	387520GB0

### OPTIONAL

PAR16 6.5W | GU10 | phase-cut dim

CODE	
2700K   460lm	901228W3
2700K   437lm	901228B3
3000K   500lm	901228W5
3000K   457lm	901228B5

CODE	
387620WW0	387620GG0
387620BB0	387620GW0
387620BG0	387620GB0

### OPTIONAL

PAR16 6.5W | GU10 | phase-cut dim

CODE	
2700K   460lm	901228W3
2700K   437lm	901228B3
3000K   500lm	901228W5
3000K   457lm	901228B5

back

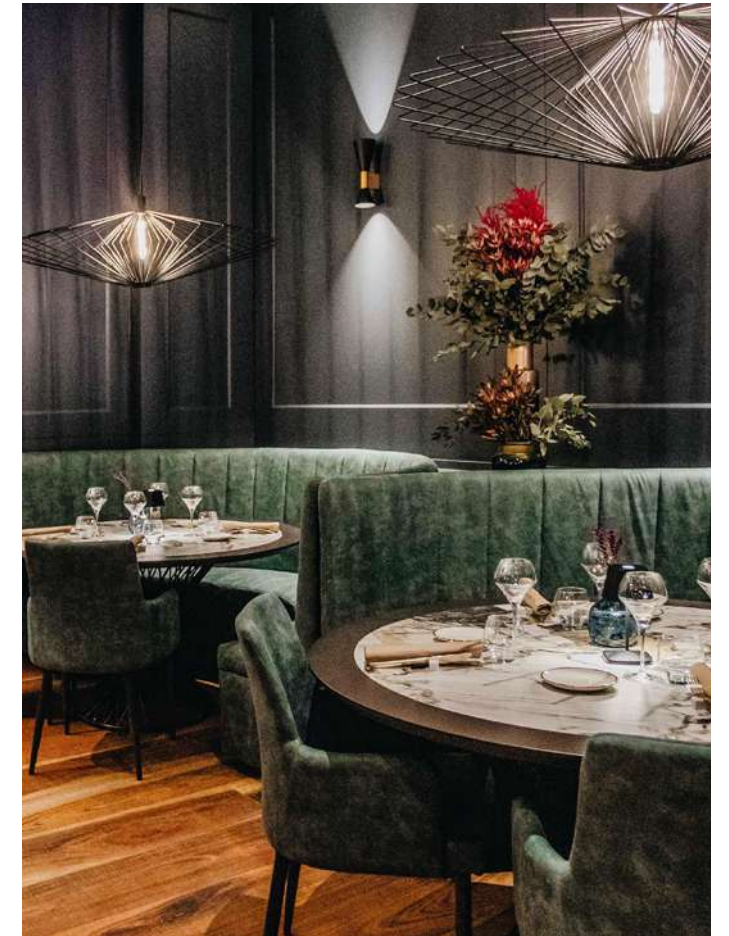

# Simple formality

Even if maths and angles were never your forte: You'll still love these four stunning geometric shapes. BOX, DOCUS, HEXO, and RAY are hard to beat when it comes to elegance and flexibility. And it means they are suitable for almost any room situation. It doesn't matter whether you let them glitter from the ceiling or shine from the walls. As these simple, narrow luminaires do not just come in a great variety of colours, they are also available in many different finishes; including for outdoors. So, right from the entrance to your house, friends and family will experience that "wow" effect. Who would have thought that geometry could be so illuminating?



[weverducre.com/universalstars](http://weverducre.com/universalstars)

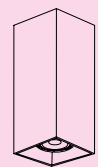

BOX

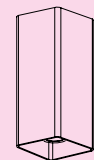

DOCUS

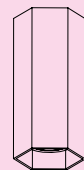

HEXO



RAY

Auch wenn Mathematik nicht Ihr Lieblingsfach war: Diese vier atemberaubenden geometrischen Formen werden Sie lieben. BOX, DOCUS, HEXO und RAY sind in puncto Eleganz und Flexibilität nämlich kaum zu übertreffen. Und deshalb für nahezu jede Raumsituation geeignet. Ganz egal, ob man sie von der Decke blinzeln oder von den Wänden strahlen lässt. Denn die schlichten, schmalen Leuchten sind nicht nur in verschiedenen tollen Farbtönen, sondern auch in vielen verschiedenen Ausführungen erhältlich. Auch für den Außenbereich. So kann man lieben Freunden und Verwandten schon im Eingangsbereich ein staunendes „Wow“ entlocken. Wer hätte gedacht, dass Geometrie so spannend sein kann?



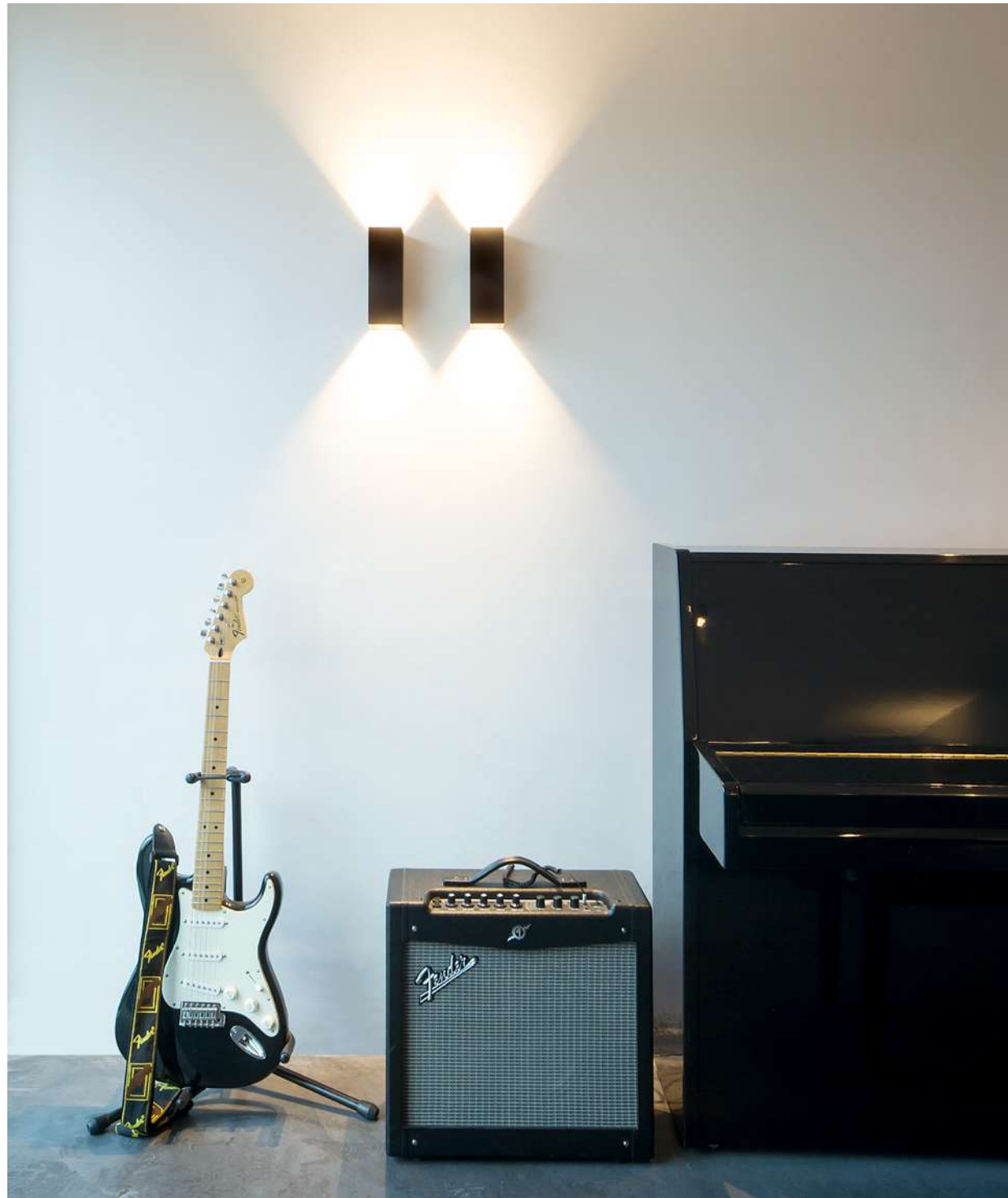

# BOX mini

Wall surface



165

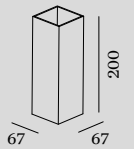
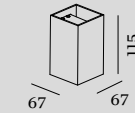
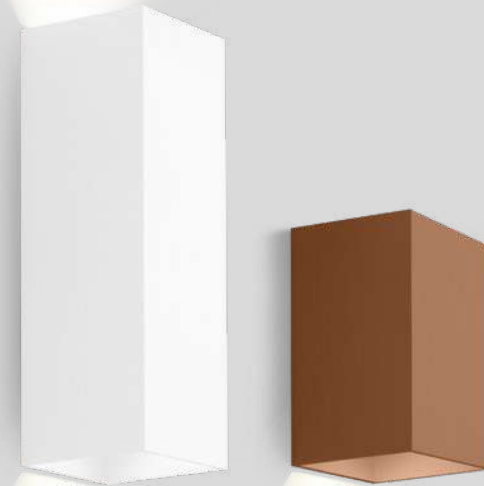

## 1.0

PAR16 max. 12W | GU10  
100-240VAC | 50-60Hz  
aluminium

IP20 0.24kg

## 2.0

2x PAR16 max. 12W | GU10  
100-240VAC | 50-60Hz  
aluminium

IP20 0.44kg

	CODE
	300120W0
	300120L0
	300120G0
	300120M0
	300120P0
	300120B0

	CODE
	301120W0
	301120L0
	301120G0
	301120M0
	301120P0
	301120B0

## OPTIONAL

PAR16 6.5W | GU10 | phase-cut dim

	CODE
	2700K   460lm 901228W3
	2700K   437lm 901228B3
	3000K   500lm 901228W5
	3000K   457lm 901228B5

## OPTIONAL

PAR16 6.5W | GU10 | phase-cut dim

	CODE
	2700K   460lm 901228W3
	2700K   437lm 901228B3
	3000K   500lm 901228W5
	3000K   457lm 901228B5



# BOX

Wall surface



## 1.0 LED

LED PCB 6W | phase-cut dim  
220-240VAC | 50-60Hz  
aluminium

IP20 SDCM3 L80|55K 0.60kg

CODE	CODE
341168W_	341148W_
341168L_	341148L_
341168G_	341148G_
341168M_	341148M_
341168Q_	341148Q_
341168P_	341148P_
341168B_	341148B_

incl. adjustable flaps

LIGHT COLOUR	LUMEN CRI	CODE
2700K	350 >90	3
3000K	370 >90	5
1800-2850K	330 >90	9

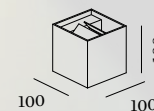

## 2.0 LED

LED PCB 11W | phase-cut dim  
220-240VAC | 50-60Hz  
aluminium

IP20 SDCM3 L80|55K 0.67kg

CODE	CODE
3211GOWO	3211GOWO
3211GOLo	3211GOLo
3211GOGO	3211GOGO
3211GOMO	3211GOMO
3211GOQO	3211GOQO
3211GOPo	3211GOPo
3211GOB0	3211GOB0

incl. adjustable flaps

LIGHT COLOUR	LUMEN CRI	CODE
2700K	2x440 >90	3
3000K	2x460 >90	5
1800-2850K	2x410 >90	9

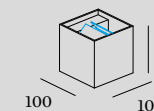

## 1.0 QT14

QT14 max. 75W | G9  
220-240VAC | 50-60Hz  
aluminium

IP20 SDCM3 L80|55K 0.66kg

CODE	CODE
900401W0	900401W0
9010G802	9010G802
9010G804	9010G804

### OPTIONAL

flaps for adjustable beam angle

CODE	CODE
900401W0	900401W0
9010G802	9010G802
9010G804	9010G804

QT14 3W | G9 | phase-cut dim | clear

CODE	CODE
9010G802	9010G802
9010G804	9010G804

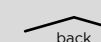

back

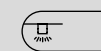

169

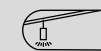

311



695



733



# BOX

Wall surface



169



311



695



733

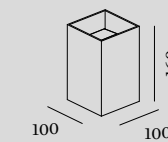

## 4.0 LED

LED PCB 11W | phase-cut dim  
220-240VAC | 50-60Hz  
aluminium

IP20 SDCM3 L80|55K 0.86kg

	CODE
	341248W_
	341248L_
	341248G_
	341248M_
	341248Q_
	341248P_
	341248B_

incl. adjustable flaps

LIGHT COLOUR	LUMEN   CRI	CODE
2700K	2x325   >90	3
3000K	2x345   >90	5
1800-2850K	2x310   >90	9

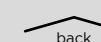

back



RESTAURANT HABEL | 6-VORNE BERLIN | GERMANY

# DOCUS mini

Wall surface



173

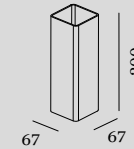
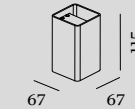

## 1.0

PAR16 max. 12W | GU10  
100-240VAC | 50-60Hz  
aluminium

IP20 0.24kg

## 2.0

2x PAR16 max. 12W | GU10  
100-240VAC | 50-60Hz  
aluminium

IP20 0.43kg

	CODE
	300320W0
	300320L0
	300320G0
	300320P0
	300320B0

	CODE
	301320W0
	301320L0
	301320G0
	301320P0
	301320B0

## OPTIONAL

PAR16 6.5W | GU10 | phase-cut dim

	CODE	
	2700K   460lm	901228W3
	2700K   437lm	901228B3
	3000K   500lm	901228W5
	3000K   457lm	901228B5

## OPTIONAL

PAR16 6.5W | GU10 | phase-cut dim

	CODE	
	2700K   460lm	901228W3
	2700K   437lm	901228B3
	3000K   500lm	901228W5
	3000K   457lm	901228B5

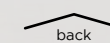

back



# HEXO mini

Wall surface

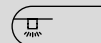

179

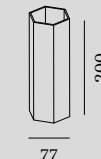
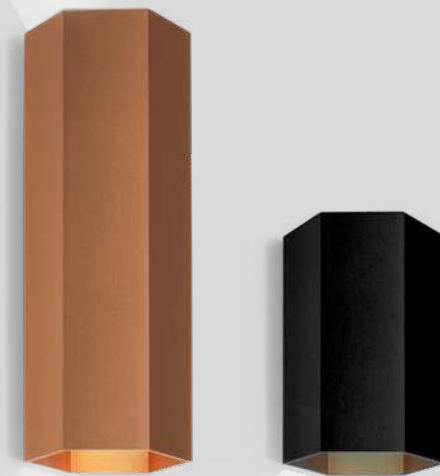

## 1.0

PAR16 max. 12W | GU10  
100-240VAC | 50-60Hz  
aluminium

IP20 0.23kg

CODE	
	300420G0
	300420Q0
	300420P0
	300420B0

## OPTIONAL

PAR16 6.5W | GU10 | phase-cut dim

CODE		
	2700K   460lm	901228W3
	2700K   437lm	901228B3
	3000K   500lm	901228W5
	3000K   457lm	901228B5

## 2.0

2x PAR16 max. 12W | GU10  
100-240VAC | 50-60Hz  
aluminium

IP20 0.40kg

CODE	
	301420G0
	301420Q0
	301420P0
	301420B0

## OPTIONAL

PAR16 6.5W | GU10 | phase-cut dim

CODE		
	2700K   460lm	901228W3
	2700K   437lm	901228B3
	3000K   500lm	901228W5
	3000K   457lm	901228B5





# RAY mini

Wall surface

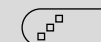

187

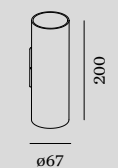
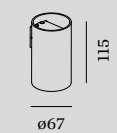
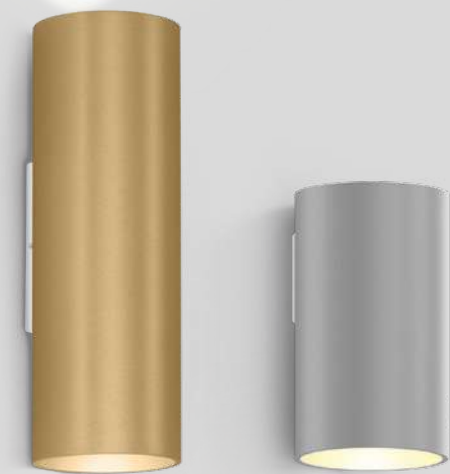

### 1.0

PAR16 max. 12W | GU10  
100-240VAC | 50-60Hz  
aluminium

IP20 0.21kg

	CODE
	300220W0
	300220L0
	300220G0
	300220M0
	300220P0
	300220B0

### OPTIONAL

PAR16 6.5W | GU10 | phase-cut dim

	CODE
2700K   460lm	901228W3
2700K   437lm	901228B3
3000K   500lm	901228W5
3000K   457lm	901228B5

### 2.0

2x PAR16 max. 12W | GU10  
100-240VAC | 50-60Hz  
aluminium

IP20 0.36kg

	CODE
	301220W0
	301220L0
	301220G0
	301220M0
	301220P0
	301220B0

### OPTIONAL

PAR16 6.5W | GU10 | phase-cut dim

	CODE
2700K   460lm	901228W3
2700K   437lm	901228B3
3000K   500lm	901228W5
3000K   457lm	901228B5

back



DE BRINK VAN PARK BOSWIJK | STUDIO ID+ DOORN | THE NETHERLANDS

# RAY

Wall surface

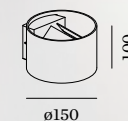
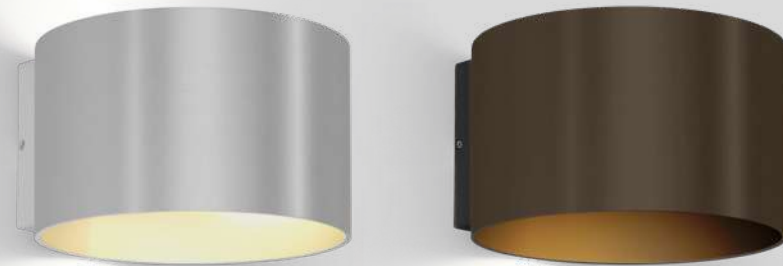

ø150

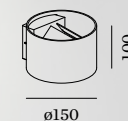

ø150

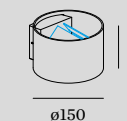

ø150

## 1.0 LED

LED LED PCB 6W | phase-cut dim  
220-240VAC | 50-60Hz  
aluminium

IP20 SDCM3 L80|55K 0.62kg

	CODE
	342168W_
	342168L_
	342168G_
	342168M_
	342168Q_
	342168P_
	342168B_

incl. adjustable flaps

LIGHT COLOUR	LUMEN CRI	CODE
2700K	350 >90	3
3000K	370 >90	5
1800-2850K	330 >90	9

## 2.0 LED

LED LED PCB 11W | phase-cut dim  
220-240VAC | 50-60Hz  
aluminium

IP20 SDCM3 L80|55K 0.69kg

	CODE
	342148W_
	342148L_
	342148G_
	342148M_
	342148Q_
	342148P_
	342148B_

incl. adjustable flaps

LIGHT COLOUR	LUMEN CRI	CODE
2700K	2x440 >90	3
3000K	2x460 >90	5
1800-2850K	2x410 >90	9

## 1.0 QT14

QT14 max. 75W | G9  
220-240VAC | 50-60Hz  
aluminium

IP20 0.62kg

	CODE
	3221G0W0
	3221G0L0
	3221G0G0
	3221G0M0
	3221G0Q0
	3221G0P0
	3221G0B0

## OPTIONAL

flaps for adjustable beam angle

	CODE
	900401W0

QT14 3W | G9 | phase-cut dim | clear  
CODE

2700K   300lm	9010G802
3000K   280lm	9010G804



OFFICE MORGAN MCKINLEY | INTERIOR DESIGN VALMONT SYDNEY | AUSTRALIA

# RAY

Wall surface

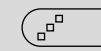
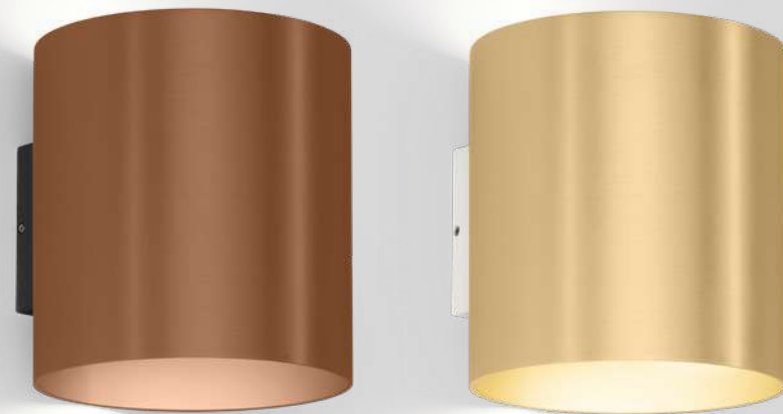

189

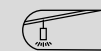

317 | 343 | 355

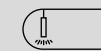

469



689



721

## 4.0 LED

LED PCB 11W | phase-cut dim  
220-240VAC | 50-60Hz  
aluminium

IP20 SDCM3 L80|55K 0.85kg

	CODE
	342248W_
	342248L_
	342248G_
	342248M_
	342248Q_
	342248P_
	342248B_

incl. adjustable flaps

LIGHT COLOUR	LUMEN   CRI	CODE
2700K	2x325   >90	3
3000K	2x345   >90	5
1800-2850K	2x310   >90	9

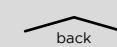



# TRAIN

Wall surface

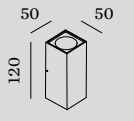
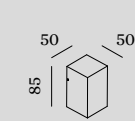

## 1.0

LED COB 6W | phase-cut dim  
220-240VAC | 50-60Hz  
aluminium

IP20 36° SDCM3 L70|55K 0.24kg

2700K | CRI >90 | 520lm

	CODE
	306868W3
	306868G3
	306868B3

3000K | CRI >90 | 570lm

	CODE
	306868W5
	306868L5

## 2.0

LED COB 9W | phase-cut dim  
220-240VAC | 50-60Hz  
aluminium

IP20 36° SDCM3 L70|55K 0.35kg

2700K | CRI >90 | 2x360lm

	CODE
	306968W3
	306968G3
	306968B3

3000K | CRI >90 | 2x375lm

	CODE
	306968W5
	306968L5

back



# CENTRAL

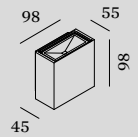
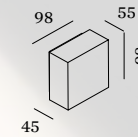

Wall surface



## 1.0

LED COB 8W | phase-cut dim  
220-240VAC | 50-60Hz | incl. driver  
aluminium

IP20 SDCM3 L80|60K 0.56kg



CODE	
	313574W_
	313574L_
	313574G_
	313574B_

LIGHT COLOUR	LUMEN CRI	CODE
2700K	580 >90	3
3000K	620 >90	5

## 2.0

LED COB 8W | phase-cut dim  
220-240VAC | 50-60Hz | incl. driver  
aluminium

IP20 SDCM3 L80|60K 0.50kg

CODE	
	313674W_
	313674L_
	313674G_
	313674B_

LIGHT COLOUR	LUMEN CRI	CODE
2700K	2x315 >90	3
3000K	2x340 >90	5



OFFICE CEEBE | WEYGERS HASSELT | BELGIUM

# LEENS

Wall surface

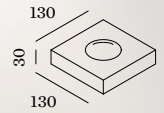
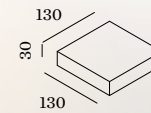

## 1.0

LED COB 8W | phase-cut dim  
220-240VAC | 50-60Hz | incl. driver  
aluminium

IP20 SDCM3 L80|60K 1.11kg

3000K | CRI >90 | 525lm

CODE

311174W5

311174L5

311174B5

## 2.0

LED COB 8W | phase-cut dim  
220-240VAC | 50-60Hz | incl. driver  
aluminium

IP20 SDCM3 L80|60K 0.90kg

3000K | CRI >90 | 2x315lm

CODE

311274W5

311274L5

311274B5

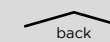

back



# BENTO

Wall surface

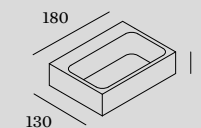

**1.3**

LED COB 8W | phase-cut dim  
220-240VAC | 50-60Hz | incl. driver  
aluminium

IP20 SDCM3 L80I60K 0.74kg

3000K | CRI >90 | 270lm

CODE

309274W5

309274B5

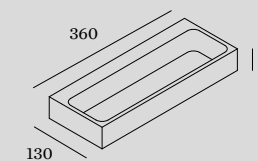

**3.6**

LED COB 8W | phase-cut dim  
220-240VAC | 50-60Hz | incl. driver  
aluminium

IP20 SDCM3 L80I60K 1.48kg

3000K | CRI >90 | 270lm

CODE

309374W5

309374B5

back



DRO

Wall surface

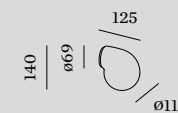
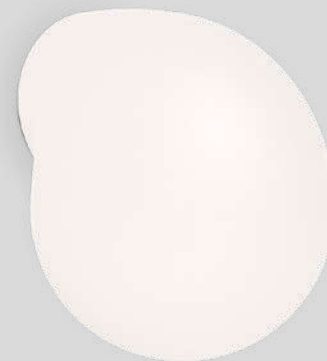

**1.0**

QT14 max. 5W | G9  
220-240VAC | 50-60Hz  
aluminium  
artisanal Italian hand blown glass  
mirror thickness 3-6mm

⊕ IP44 0.60kg

⌚ 69-71



**2.0**

C35 max. 6W | E14  
220-240VAC | 50-60Hz  
aluminium  
artisanal Italian hand blown glass  
mirror thickness 3-6mm

⊕ IP44 1.03kg

⌚ 105-107

CODE

3431G0W0

CODE

3432C0W0

**OPTIONAL**

QT14 3W | G9 | phase-cut dim | clear  
CODE  
2700K | 300lm 9010G802  
3000K | 280lm 9010G804

**OPTIONAL**

C35 5.5W | E14 | phase-cut dim  
opal  
CODE  
2700K | 450lm 9003C103

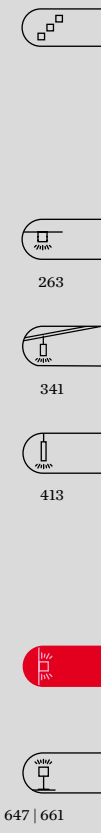





PRIVATE RESIDENCE | MAADSTUDIO MAREK SVOBODA CZECH REPUBLIC

# DARF

Wall surface

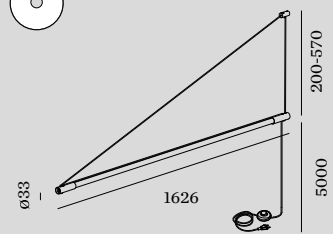
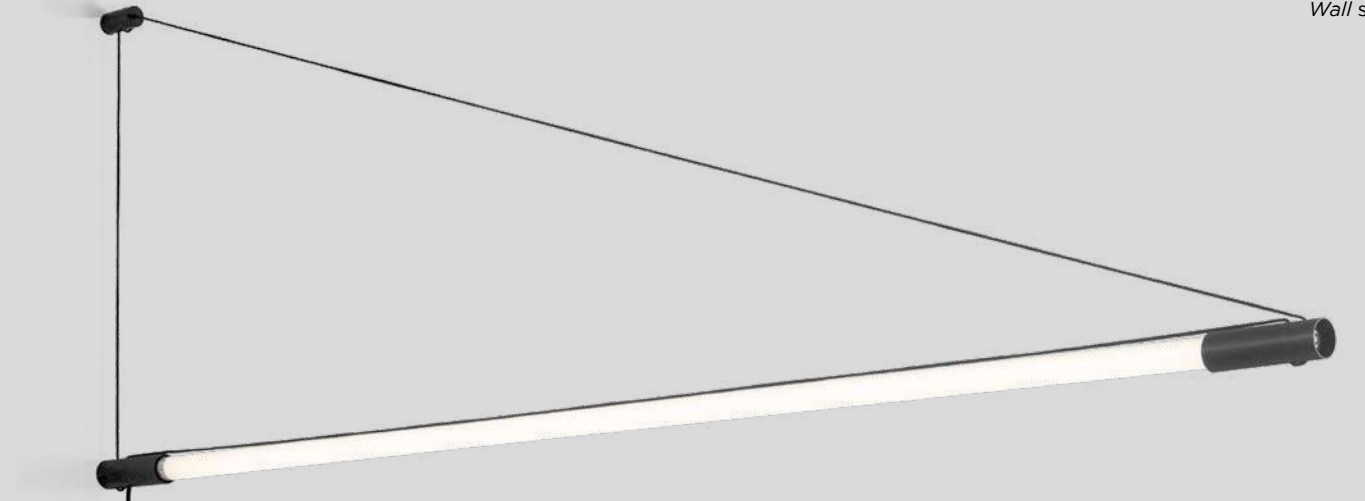

## 1.1

LED TUBE 22W | non dim  
220-240VAC | 50-60Hz  
aluminium  
black textile cable plug with  
switch

IP20 SDCM3 L70|60K 0.33kg

3000K | CRI >80 | 3560lm

CODE

2563T7B4

4000K | CRI >80 | 3950lm

CODE

2563T7B6

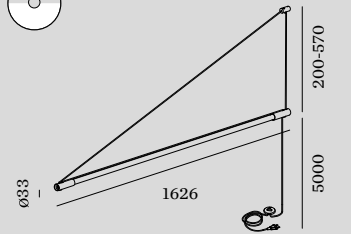

## 1.2

LED TUBE 23W | phase-cut dim  
220-240VAC | 50-60Hz  
aluminium  
black textile cable plug with  
dimmer switch

IP20 SDCM3 L70|50K 0.33kg

2700K | CRI >90 | 2780lm

CODE

2563T8B3

3000K | CRI >90 | 2940lm

CODE

2563T8B5



# ROOMOR

Wall surface



reddot award 2019  
winner lighting design

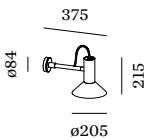

## 1.1

PAR16 max. 15W | GU10  
100-240VAC | 50-60Hz  
aluminium

IP20 0°-45° 0.99kg

CODE

338120BK1

338120BB1

## OPTIONAL

PAR16 6.5W | GU10 | phase-cut dim

CODE

2700K | 437lm 901228B3

3000K | 457lm 901228B5

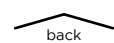



# ROOMOR

Wall surface



reddot award 2019  
winner lighting design



### 3.1

PAR16 max. 15W | GU10  
100-240VAC | 50-60Hz  
aluminium | steel  
cable plug with hand switch

IP20 0°-45°|0°-30° 1.36kg

CODE	
	339120BK1
	339120BB1

### OPTIONAL

PAR16 6.5W   GU10   phase-cut dim		CODE
	2700K   437lm	901228B3
	3000K   457lm	901228B5

### 3.1

PAR16 max. 15W | GU10  
100-240VAC | 50-60Hz  
aluminium | steel  
cable base round

IP20 0°-45°|0°-30° 1.29kg

CODE	
	339220BK1
	339220BB1

### OPTIONAL

PAR16 6.5W   GU10   phase-cut dim		CODE
	2700K   437lm	901228B3
	3000K   457lm	901228B5

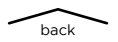



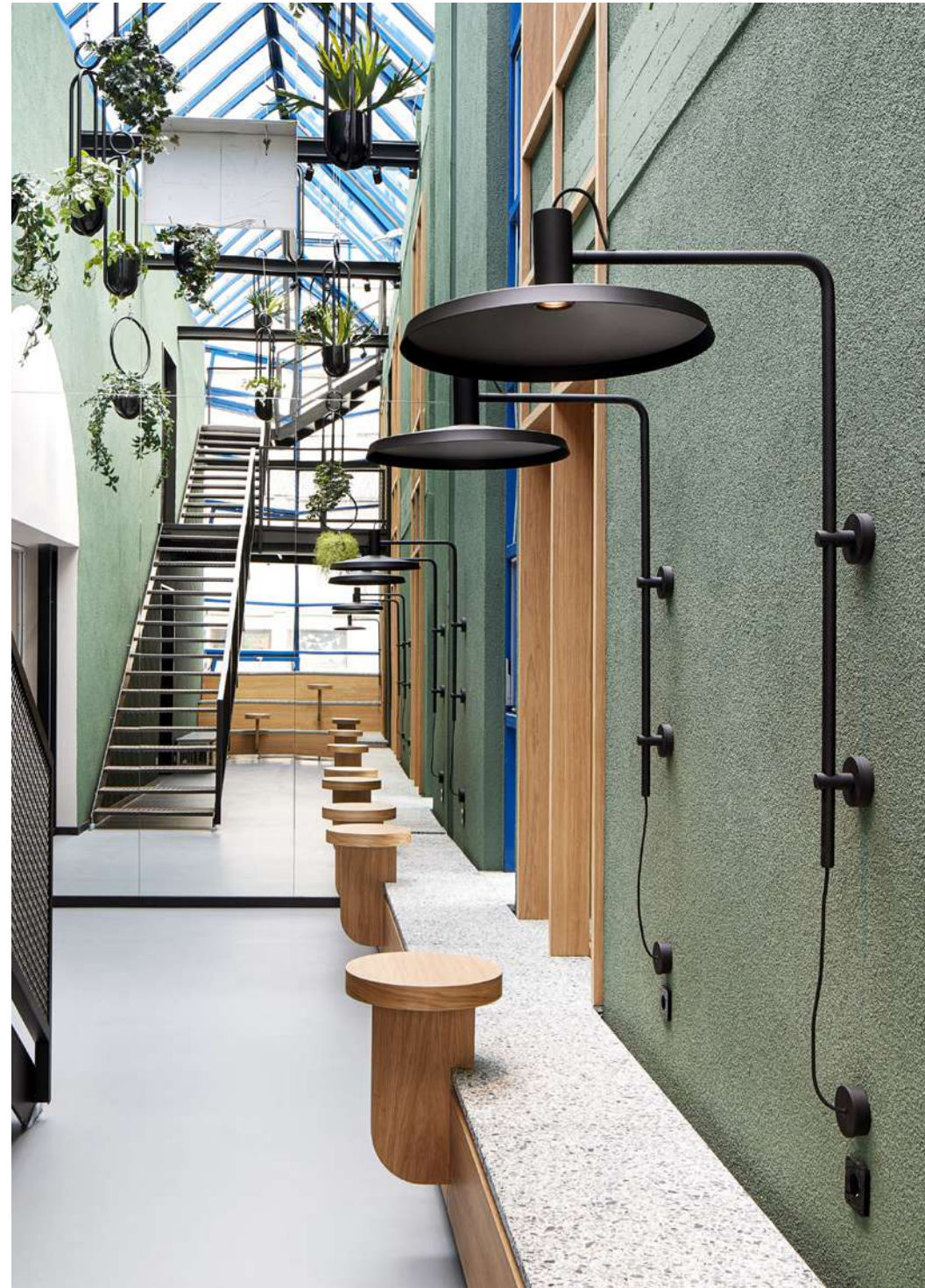

URBAN SPACES | STUDIO KOMO STUTT GART | GERMANY



BF2

BK3

BB4

ROOMOR

Wall surface



reddot award 2019  
winner lighting design

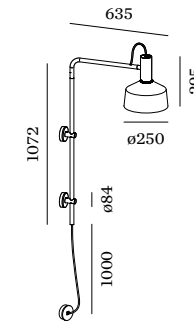
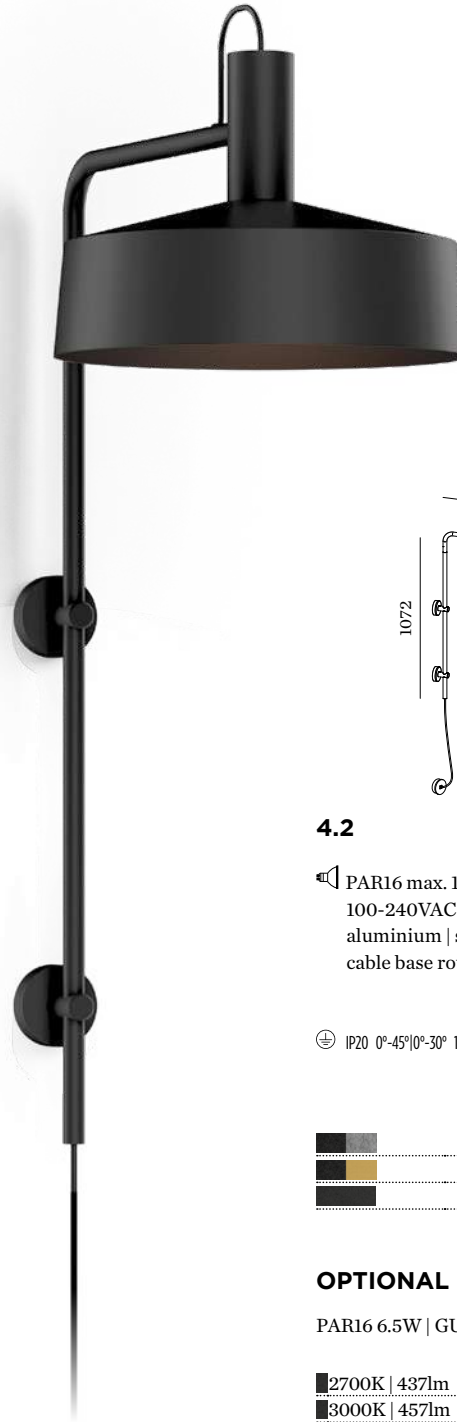

4.2

PAR16 max. 15W | GU10  
100-240VAC | 50-60Hz  
aluminium | steel | grey felt  
cable base round

⊕ IP20 0°-45°|0°-30° 1.87kg|1.70kg

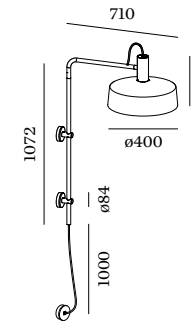

4.3

PAR16 max. 15W | GU10  
100-240VAC | 50-60Hz  
aluminium | steel | grey felt  
cable base round

⊕ IP20 0°-45°|0°-30° 2.37kg|2.24kg

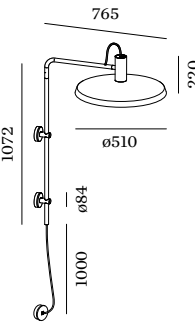

4.4

PAR16 max. 15W | GU10  
100-240VAC | 50-60Hz  
aluminium | steel  
cable base round

⊕ IP20 0°-45°|0°-30° 2.48kg

CODE	
	339620BF2
	339620BK2
	339620BB2

CODE	
	339620BF3
	339620BK3
	339620BB3

CODE	
	339620BK4
	339620BB4

OPTIONAL

PAR16 6.5W   GU10   phase-cut dim	
CODE	
	2700K   437lm 901228B3
	3000K   457lm 901228B5

OPTIONAL

PAR16 6.5W   GU10   phase-cut dim	
CODE	
	2700K   437lm 901228B3
	3000K   457lm 901228B5

OPTIONAL

PAR16 6.5W   GU10   phase-cut dim	
CODE	
	2700K   437lm 901228B3
	3000K   457lm 901228B5



# WIRO

Wall surface



## 1.0 CONE

T30 max. 25W | E27  
220-240VAC | 50-60Hz  
aluminium | steel

IP20 1.50kg

CODE	
	3341E0V0
	3341E0B0

## OPTIONAL

T30-225 5.3W | E27 | phase-cut dim  
gold tinted

CODE	
2200K   382lm	9003E129
2700K   425lm	9003E136

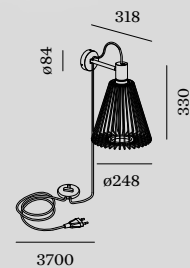

## 1.0 CONE PLUG

T30 max. 25W | E27 | dimmable  
220-240VAC | 50-60Hz  
aluminium | steel  
cable plug with dimmer switch

IP20 1.65kg

CODE	
	3343E0V0
	3343E0B0

## OPTIONAL

T30-225 5.3W | E27 | phase-cut dim  
gold tinted

CODE	
2200K   382lm	9003E129
2700K   425lm	9003E136

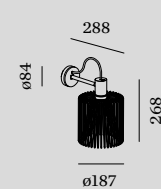

## 1.8 WIRO

T30 max. 25W | E27  
220-240VAC | 50-60Hz  
aluminium | steel

IP20 1.60kg

CODE	
	3345E0V0
	3345E0B0

## OPTIONAL

T30-225 5.3W | E27 | phase-cut dim  
gold tinted

CODE	
2200K   382lm	9003E129
2700K   425lm	9003E136

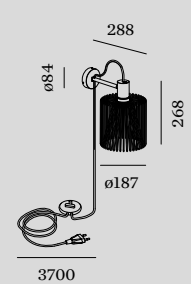

## 1.8 WIRO PLUG

T30 max. 25W | E27 | dimmable  
220-240VAC | 50-60Hz  
aluminium | steel  
cable plug with dimmer switch

IP20 1.75kg

CODE	
	3346E0V0
	3346E0B0

## OPTIONAL

T30-225 5.3W | E27 | phase-cut dim  
gold tinted

CODE	
2200K   382lm	9003E129
2700K   425lm	9003E136



# CLEA

Wall surface



271



483

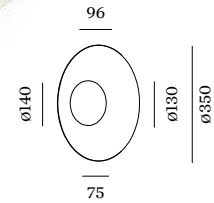
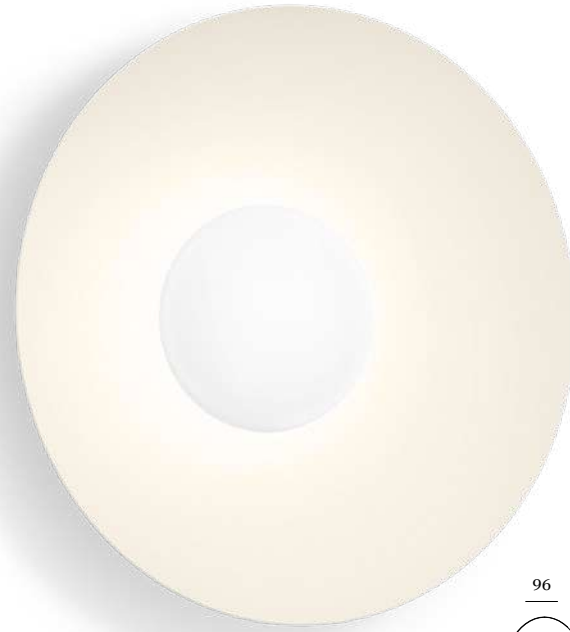

## 1.0

LED COB 10W | phase-cut dim  
220-240VAC | 50-60Hz | incl. driver  
aluminium  
white opal glass hand blown

IP20 SDCM2 L80|50K 0.78kg

	CODE
	181484W_
	181484LS_
	181484SG_
	181484FJ_
	181484B_

LIGHT COLOUR	LUMEN	CRI	CODE
2700K	610	>90	3
3000K	655	>90	5

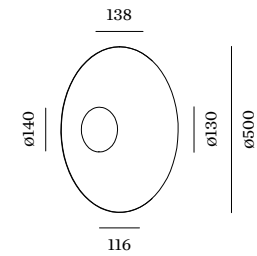

## 2.0

LED COB 10W | phase-cut dim  
220-240VAC | 50-60Hz | incl. driver  
aluminium  
white opal glass hand blown

IP20 SDCM2 L80|50K 1.31kg

	CODE
	181584W_
	181584LS_
	181584SG_
	181584FJ_
	181584B_

LIGHT COLOUR	LUMEN	CRI	CODE
2700K	610	>90	3
3000K	655	>90	5

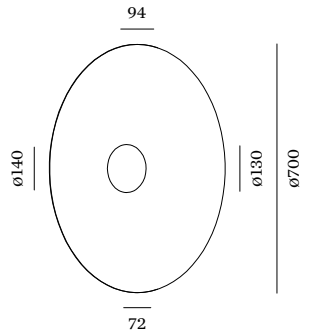

## 3.0

LED COB 10W | phase-cut dim  
220-240VAC | 50-60Hz | incl. driver  
aluminium  
white opal glass hand blown

IP20 SDCM2 L80|50K 2.09kg

	CODE
	181684W_
	181684LS_
	181684SG_
	181684FJ_
	181684B_

LIGHT COLOUR	LUMEN	CRI	CODE
2700K	610	>90	3
3000K	655	>90	5

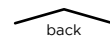



MERCURE CHANTILLY | PROJECT MANAGED BY ATYPIO HOTELS RESORTS WITH ABP ARCHITECTS | L'OBSERVATOIRE DE LA NUIT  
VINEUIL-SAINT-FIRMIN | FRANCE

J.J.W.

Wall surface

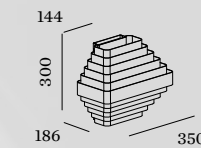
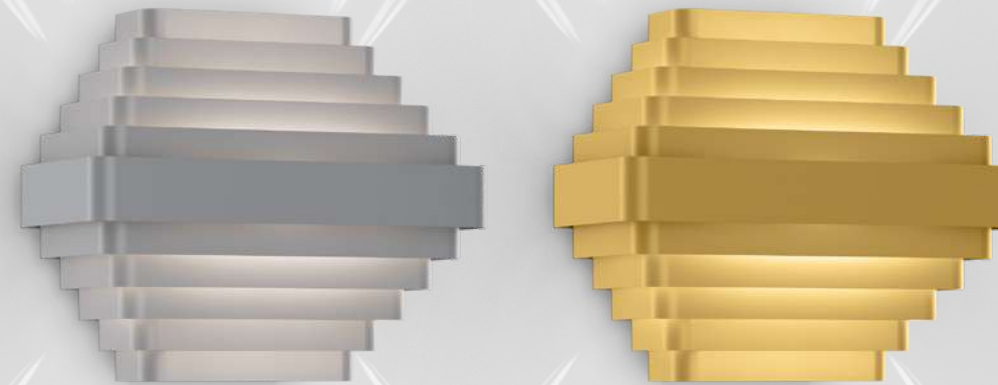

**01**

2x A60 max. 15W | E27  
220-240VAC | 50-60Hz  
aluminium

IP20 2.92kg

CODE

	2054E0S0
	2054E0G0

**OPTIONAL**

A60 3.8W/5.6W | E27 | phase-cut dim  
clear

CODE

2200K   247lm	9003E109
2700K   483lm	9003E138







HAIRDRESSER TON SUR TON | SIMON DE BACKERE KORTRIJK | BELGIUM

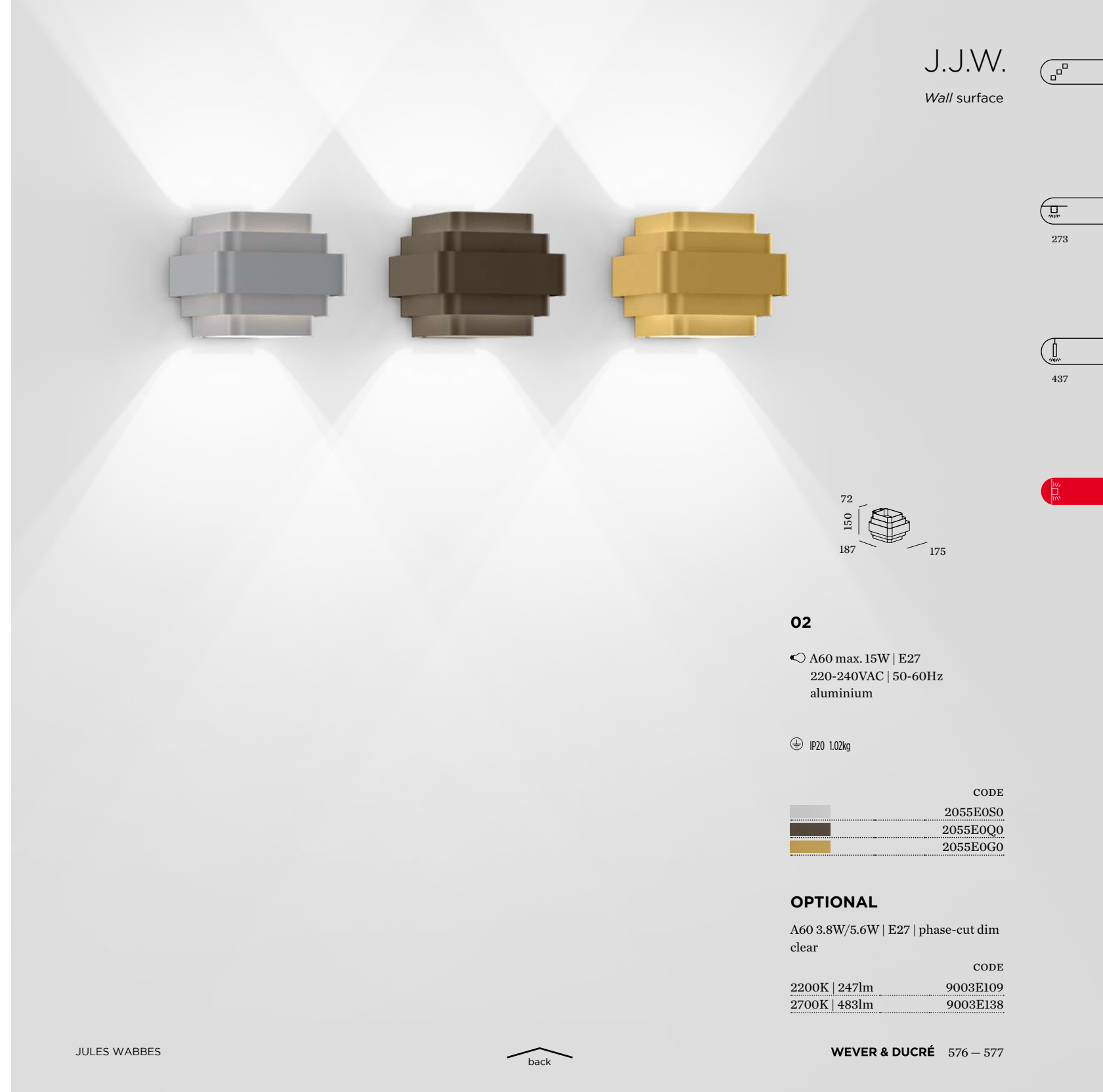

J.J.W.

Wall surface



273



437

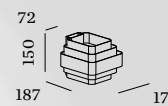

**02**

A60 max. 15W | E27  
220-240VAC | 50-60Hz  
aluminium

⊕ IP20 1.02kg

CODE

	2055E0S0
	2055E0Q0
	2055E0G0

**OPTIONAL**

A60 3.8W/5.6W | E27 | phase-cut dim  
clear

CODE

2200K   247lm	9003E109
2700K   483lm	9003E138





RESTAURANT TRIANGOLO | CONIX COOL INTERIOR EDEGEM | BELGIUM

# MIRRO

Wall surface

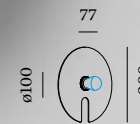
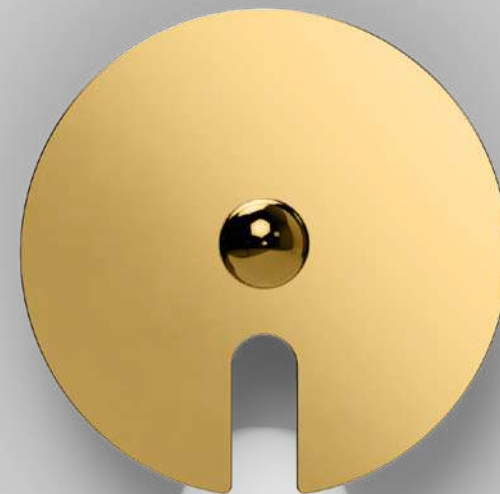

## 1.0

◀ A60 max. 15W | E27  
220-240VAC | 50-60Hz  
aluminium | one side reflective  
composite panel

⊕ IP20 0.70kg

CODE	
	6321E0GB0
	6321E0NB0
	6321E0LB0

## OPTIONAL

A60 5.5W | E27 | phase-cut dim  
gold mirror

CODE	
2700K   409lm	9003E139

A60 5.5W | E27 | phase-cut dim  
silver mirror

CODE	
2700K   409lm	9003E140

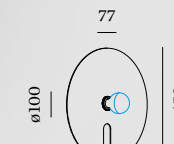

## 2.0

◀ G95 max. 15W | E27  
220-240VAC | 50-60Hz  
aluminium | one side reflective  
composite panel

⊕ IP20 1.00kg

CODE	
	6322E0GB0
	6322E0NB0
	6322E0LB0

## OPTIONAL

G95 5.1W/5.6W | E27 | phase-cut dim  
gold mirror

CODE	
2200K   371lm	9003E156
2700K   464lm	9003E142

G95 5.6W | E27 | phase-cut dim  
silver mirror

CODE	
2700K   464lm	9003E157

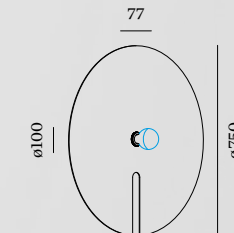

## 3.0

◀ G95 max. 15W | E27  
220-240VAC | 50-60Hz  
aluminium | one side reflective  
composite panel

⊕ IP20 2.10kg

CODE	
	6323E0GB0
	6323E0NB0
	6323E0LB0

## OPTIONAL

G95 5.1W/5.6W | E27 | phase-cut dim  
gold mirror

CODE	
2200K   371lm	9003E156
2700K   464lm	9003E142

G95 5.6W | E27 | phase-cut dim  
silver mirror

CODE	
2700K   464lm	9003E157



267

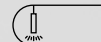

431



651 | 663



HOTEL PARK | MICHAL STAŠKO PIESTANY | SLOVAKIA

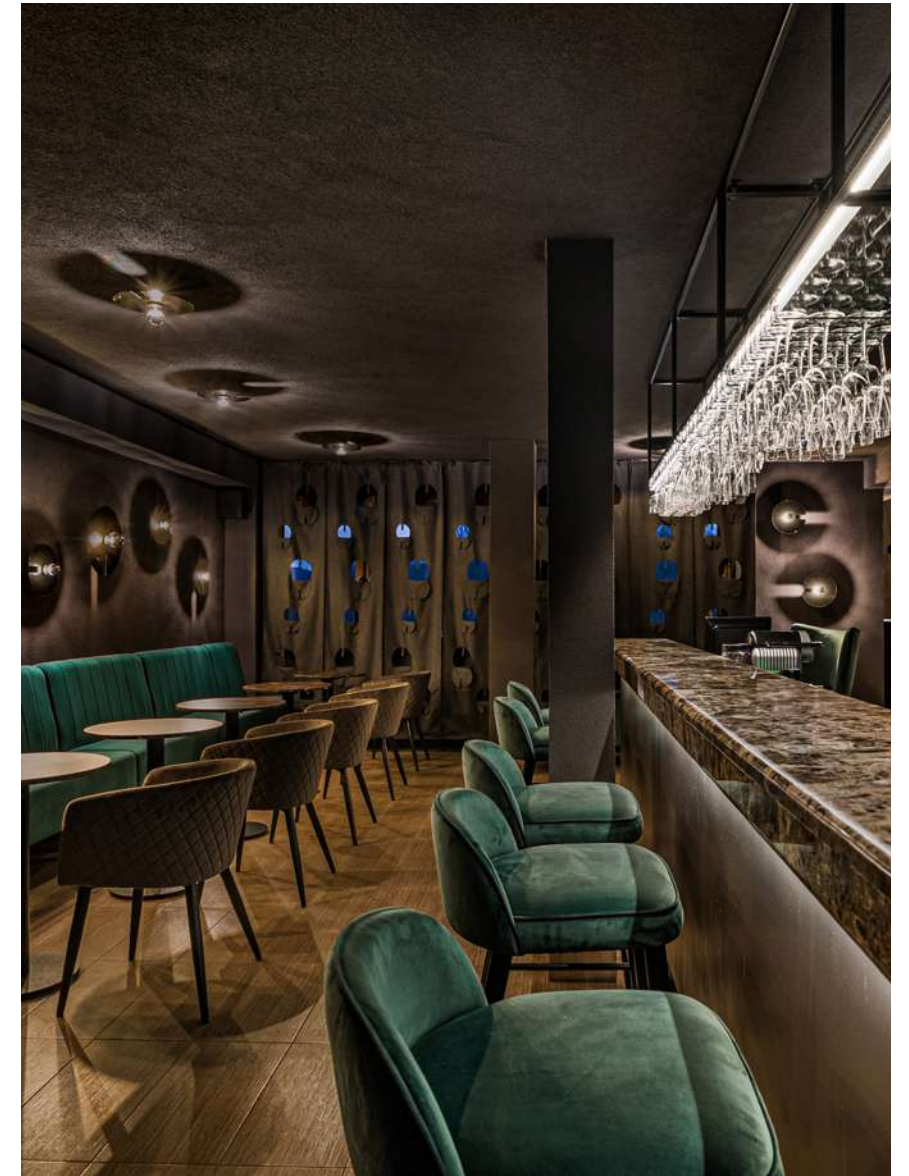

► DESIGN WITH LOVE



# MIRRO SOFT

Wall surface



269



433

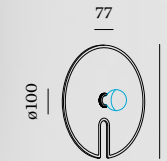
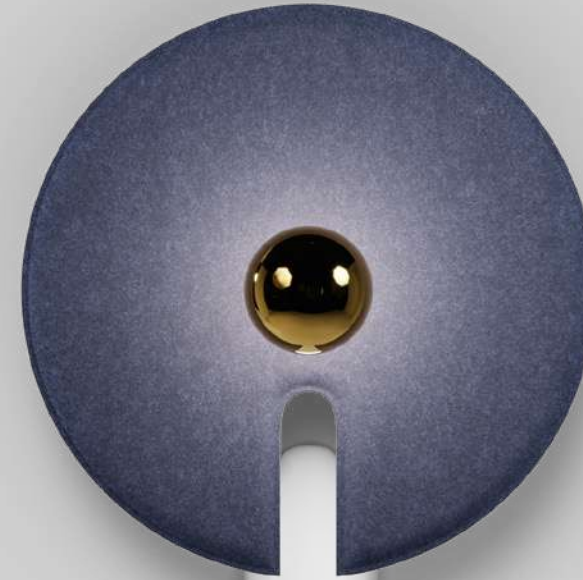

## 2.0

G95 max. 15W | E27  
220-240VAC | 50-60Hz  
aluminium | PET felt material

IP20 0.67kg

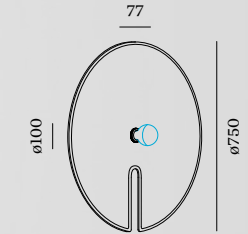

## 3.0

G95 max. 15W | E27  
220-240VAC | 50-60Hz  
aluminium | PET felt material

IP20 1.20kg

CODE

	6322E0MF0
	6322E0LF0
	6322E0IF0
	6322E0AF0

CODE

	6323E0MF0
	6323E0LF0
	6323E0IF0
	6323E0AF0

## OPTIONAL

G95 5.1W/5.6W | E27 | phase-cut dim  
gold mirror

CODE

2200K   371lm	9003E156
2700K   464lm	9003E142

G95 5.6W | E27 | phase-cut dim  
silver mirror

CODE

2700K   464lm	9003E157
---------------	----------

G95 5.5W | E27 | phase-cut dim  
clear

CODE

2700K   534lm	9003E160
---------------	----------

## OPTIONAL

G95 5.1W/5.6W | E27 | phase-cut dim  
gold mirror

CODE

2200K   371lm	9003E156
2700K   464lm	9003E142

G95 5.6W | E27 | phase-cut dim  
silver mirror

CODE

2700K   464lm	9003E157
---------------	----------

G95 5.5W | E27 | phase-cut dim  
clear

CODE

2700K   534lm	9003E160
---------------	----------





As awarded by The Chicago Athenaeum:  
Museum of Architecture and Design

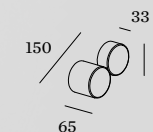

**2.0**

LED COB 8W | phase-cut dim  
220-240VAC | 50-60Hz | incl. driver  
aluminium | PC cover

IP20 SDCM2 L80|55K 0.40kg

CODE
330164W_
330164M_
330164Q_
330164B_

LIGHT COLOUR	LUMEN CRI	CODE
2700K	400 >90	3
3000K	420 >90	5

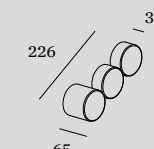

**3.0**

LED COB 16W | phase-cut dim  
220-240VAC | 50-60Hz | incl. driver  
aluminium | PC cover

IP20 SDCM2 L80|55K 0.56kg

CODE
330264W_
330264M_
330264Q_
330264B_

LIGHT COLOUR	LUMEN CRI	CODE
2700K	2x400 >90	3
3000K	2x420 >90	5

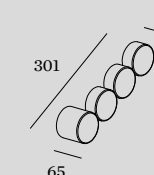

**4.0**

LED COB 21W | phase-cut dim  
220-240VAC | 50-60Hz | incl. driver  
aluminium | PC cover

IP20 SDCM2 L80|55K 0.73kg

CODE
330464W_
330464M_
330464Q_
330464B_

LIGHT COLOUR	LUMEN CRI	CODE
2700K	3x400 >90	3
3000K	3x420 >90	5







# TAPIS

Wall surface

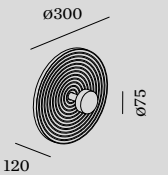

## 1.0

LED PCB 9W | phase-cut dim  
220-240VAC | 50-60Hz | incl. driver  
composite | aluminium

IP20 SDCM3 L80/50K 1.80kg

CODE	
	336174FJ_
	336174GW_
	336174ST_
	336174RA_

LIGHT COLOUR	LUMEN CRI	CODE
2700K	380 >90	3
3000K	390 >90	5



CREATE YOUR OWN TAPIS  
weverducre.com/tapis-configurator

back



# TAPIS

Wall surface

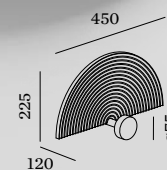
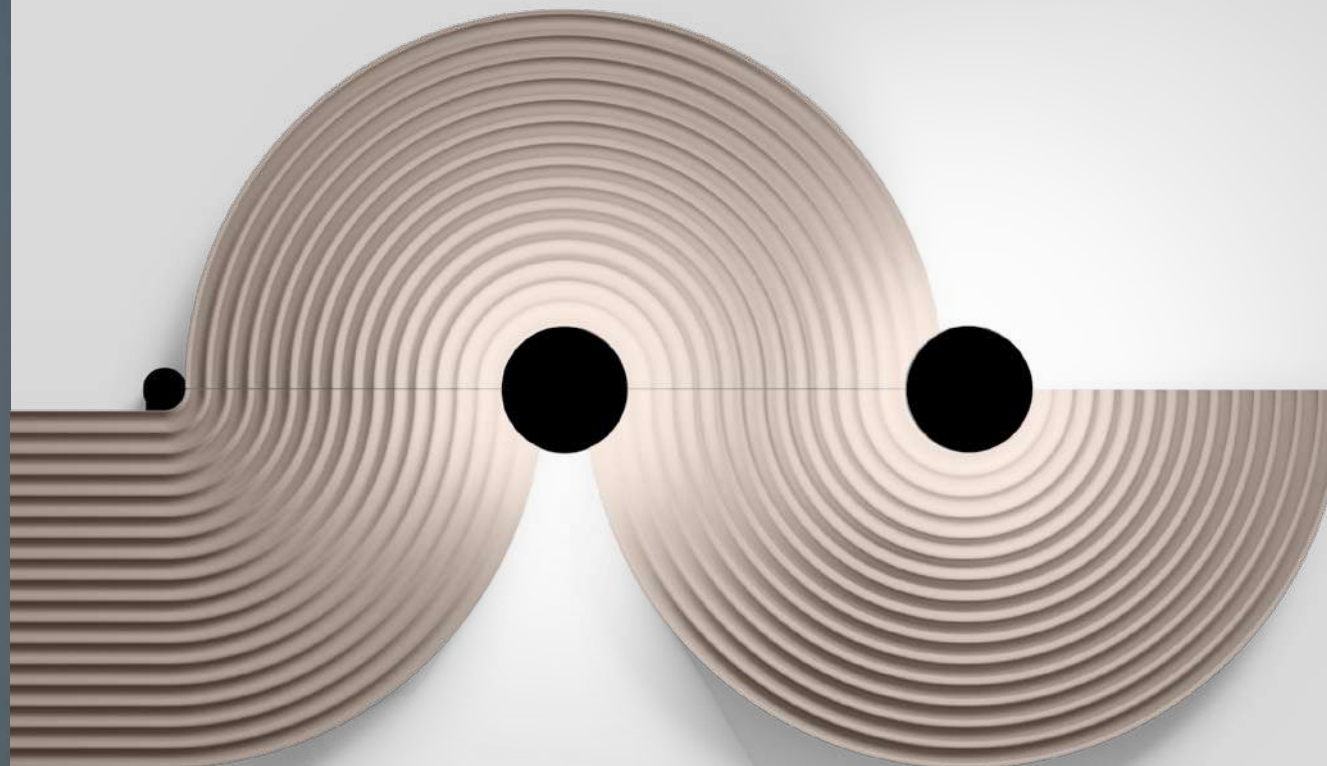

## 2.0

LED PCB 9W | phase-cut dim  
220-240VAC | 50-60Hz | incl. driver  
composite | aluminium

IP20 SDCM3 L80|50K 1.95kg

CODE
336274FJ_
336274GW_
336274ST_
336274RA_

LIGHT COLOUR	LUMEN	CRI	CODE
2700K	380	>90	3
3000K	390	>90	5

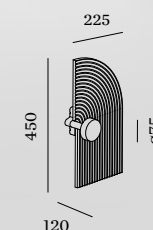

## 3.0

LED PCB 9W | phase-cut dim  
220-240VAC | 50-60Hz | incl. driver  
composite | aluminium

IP20 SDCM3 L80|50K 1.70kg

CODE
336374FJ_
336374GW_
336374ST_
336374RA_

LIGHT COLOUR	LUMEN	CRI	CODE
2700K	380	>90	3
3000K	390	>90	5

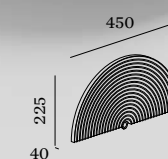

## 2.1

composite | aluminium

1.56kg

CODE
336200FJ0
336200GW0
336200ST0
336200RA0

LIGHT COLOUR	LUMEN	CRI	CODE
2700K	380	>90	3
3000K	390	>90	5

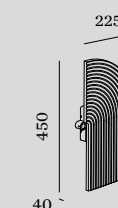

## 3.1

composite | aluminium

1.31kg

CODE
336300FJ0
336300GW0
336300ST0
336300RA0

LIGHT COLOUR	LUMEN	CRI	CODE
2700K	380	>90	3
3000K	390	>90	5

back



**CREATE YOUR OWN TAPIS**  
[weverducre.com/tapis-configurator](https://weverducre.com/tapis-configurator)



# TAPIS SOFT

Wall surface

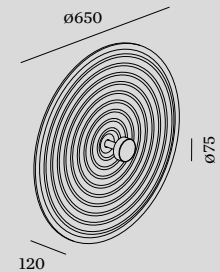
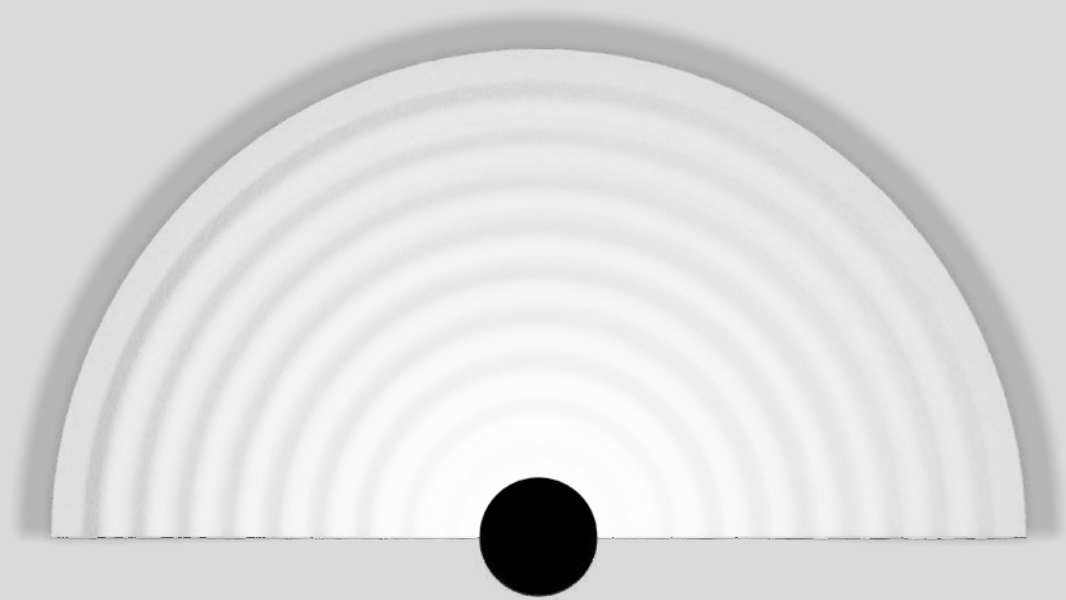

1.0

LED PCB 9W | phase-cut dim  
220-240VAC | 50-60Hz | incl. driver  
aluminium | PET felt material

IP20 SDCM3 L80|50K 1.67kg

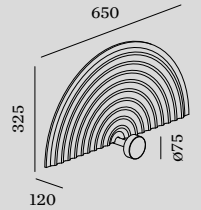

2.0

LED PCB 9W | phase-cut dim  
220-240VAC | 50-60Hz | incl. driver  
aluminium | PET felt material

IP20 SDCM3 L80|50K 1.08kg

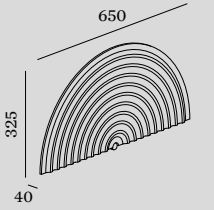

2.1

aluminium | PET felt material

0.88kg

CODE		
	336174WF_	
	336174MF_	
	336174LF_	
	336174OF_	

CODE		
	336274WF_	
	336274MF_	
	336274LF_	
	336274OF_	

CODE		
	336200WF0	
	336200MF0	
	336200LF0	
	336200OF0	

LIGHT COLOUR	LUMEN CRI	CODE
2700K	380 >90	3
3000K	390 >90	5

LIGHT COLOUR	LUMEN CRI	CODE
2700K	380 >90	3
3000K	390 >90	5



back



# TAPIS SOFT

Wall surface

**mixology**  
winner

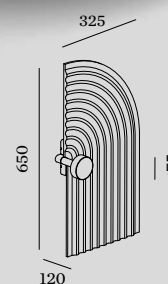
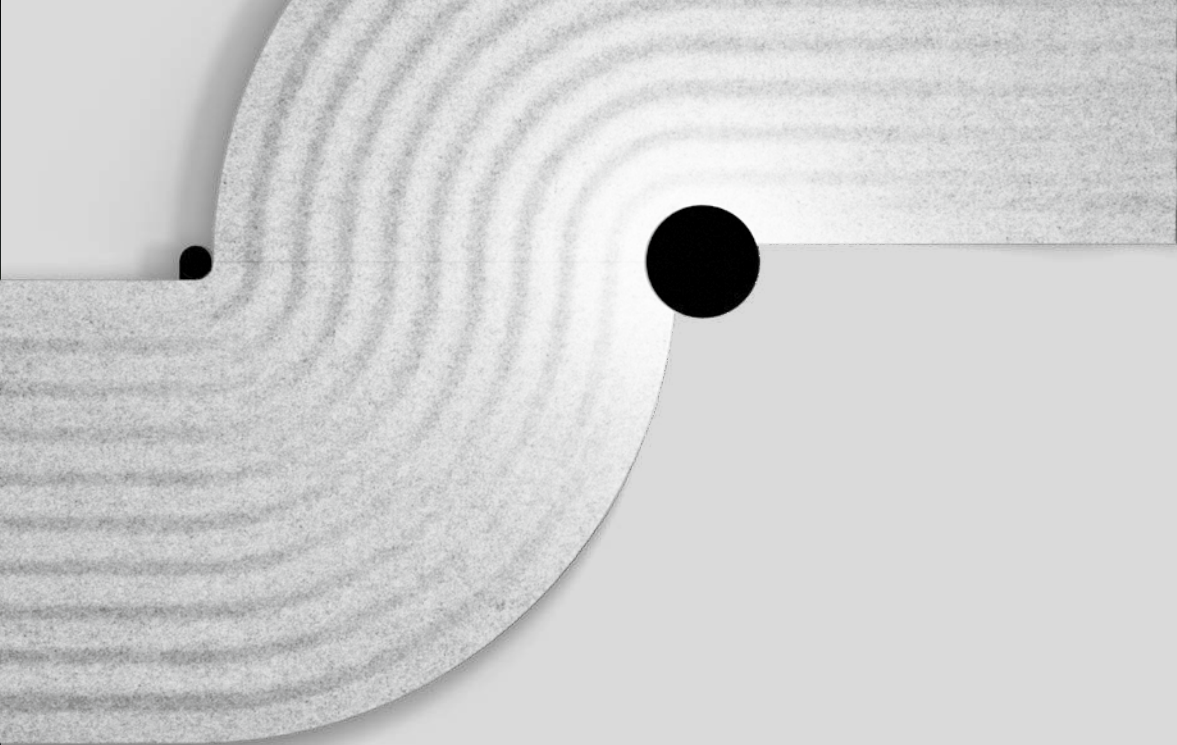

**3.0**

LED PCB 9W | phase-cut dim  
220-240VAC | 50-60Hz | incl. driver  
aluminium | PET felt material

IP20 SDCM3 L80/50K 1.14kg

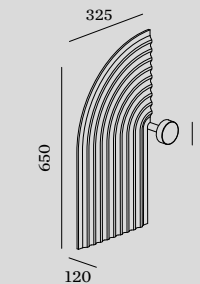

**4.0**

LED PCB 9W | phase-cut dim  
220-240VAC | 50-60Hz | incl. driver  
aluminium | PET felt material

IP20 SDCM3 L80/50K 1.14kg

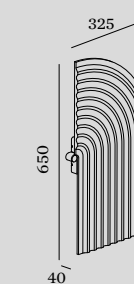

**3.1**

aluminium | PET felt material

0.94kg

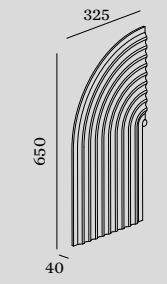

**4.1**

aluminium | PET felt material

0.94kg

	CODE
	336374WF_
	336374MF_
	336374LF_
	336374OF_

LIGHT COLOUR	LUMEN CRI	CODE
2700K	380 >90	3
3000K	390 >90	5

	CODE
	336474WF_
	336474MF_
	336474LF_
	336474OF_

LIGHT COLOUR	LUMEN CRI	CODE
2700K	380 >90	3
3000K	390 >90	5

	CODE
	336300WF0
	336300MF0
	336300LF0
	336300OF0

	CODE
	336400WF0
	336400MF0
	336400LF0
	336400OF0

back



# MILES

Wall surface

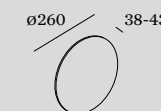
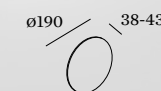
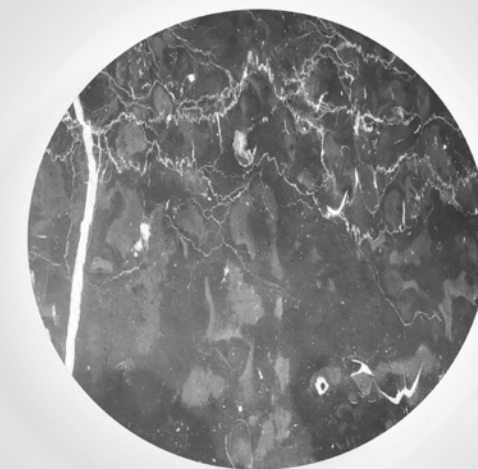

## 2.0 ROUND

LED PCB 8W | phase-cut dim  
220-240VAC | 50-60Hz  
aluminium

IP20 SDCM3 L80|60K 0.70kg|1.24kg

## 3.0 ROUND

LED PCB 8W | phase-cut dim  
220-240VAC | 50-60Hz  
aluminium

IP20 SDCM3 L80|60K 1.07kg|1.92kg

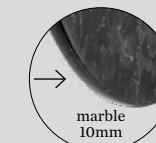
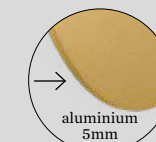

	CODE
	317578W_
	317578G_
	317578M_
	317578Q_
	317578P_
	317578CC_
	317578B_
	317578MW_
	317578MB_

LIGHT COLOUR	LUMEN CRI	CODE
2700K	600 >90	3
3000K	620 >90	5

	CODE
	317778W_
	317778G_
	317778M_
	317778Q_
	317778P_
	317778CC_
	317778B_
	317778MW_
	317778MB_

LIGHT COLOUR	LUMEN CRI	CODE
2700K	600 >90	3
3000K	620 >90	5





PRIVATE RESIDENCE | UP FOR GRABS INTERIORS UNITED KINGDOM

# MILES

Wall surface

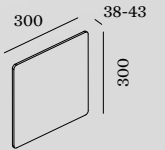
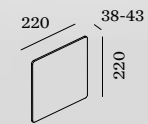

## 2.0 CARRÉ

LED PCB 8W | phase-cut dim  
220-240VAC | 50-60Hz  
aluminium

IP20 SDCM3 L80|60K 1.01kg | 2.11kg

## 3.0 CARRÉ

LED PCB 8W | phase-cut dim  
220-240VAC | 50-60Hz  
aluminium

IP20 SDCM3 L80|60K 1.56kg | 3.39kg

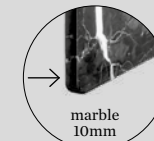
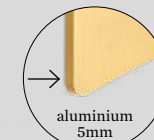

	CODE
	317478W_
	317478G_
	317478M_
	317478Q_
	317478P_
	317478B_
	marble 317478MW_
	marble 317478MB_

LIGHT COLOUR	LUMEN CRI	CODE
2700K	600 >90	3
3000K	620 >90	5

	CODE
	317678W_
	317678G_
	317678M_
	317678Q_
	317678P_
	317678B_
	marble 317678MW_
	marble 317678MB_

LIGHT COLOUR	LUMEN CRI	CODE
2700K	600 >90	3
3000K	620 >90	5





# MILES

Wall surface

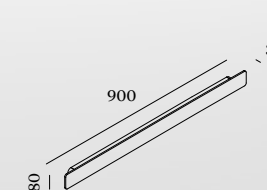

## 9.0

LED PCB 31W | phase-cut dim  
220-240VAC | 50-60Hz  
aluminium

IP20 SDCM3 L80|60K 2.01kg

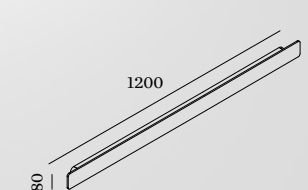

## 12.0

LED PCB 38W | phase-cut dim  
220-240VAC | 50-60Hz  
aluminium

IP20 SDCM3 L80|60K 2.60kg

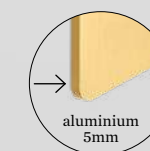

CODE
317878W_
317878G_
317878B_

LIGHT COLOUR	LUMEN CRI	CODE
2700K	1560 >90	3
3000K	1580 >90	5

CODE
317978W_
317978G_
317978B_

LIGHT COLOUR	LUMEN CRI	CODE
2700K	2130 >90	3
3000K	2160 >90	5

back



PRIVATE RESIDENCE | VLADIMIR MITROVIĆ SERBIA

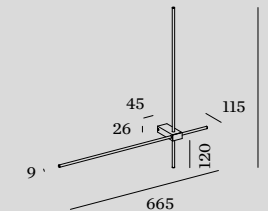
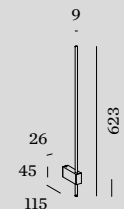
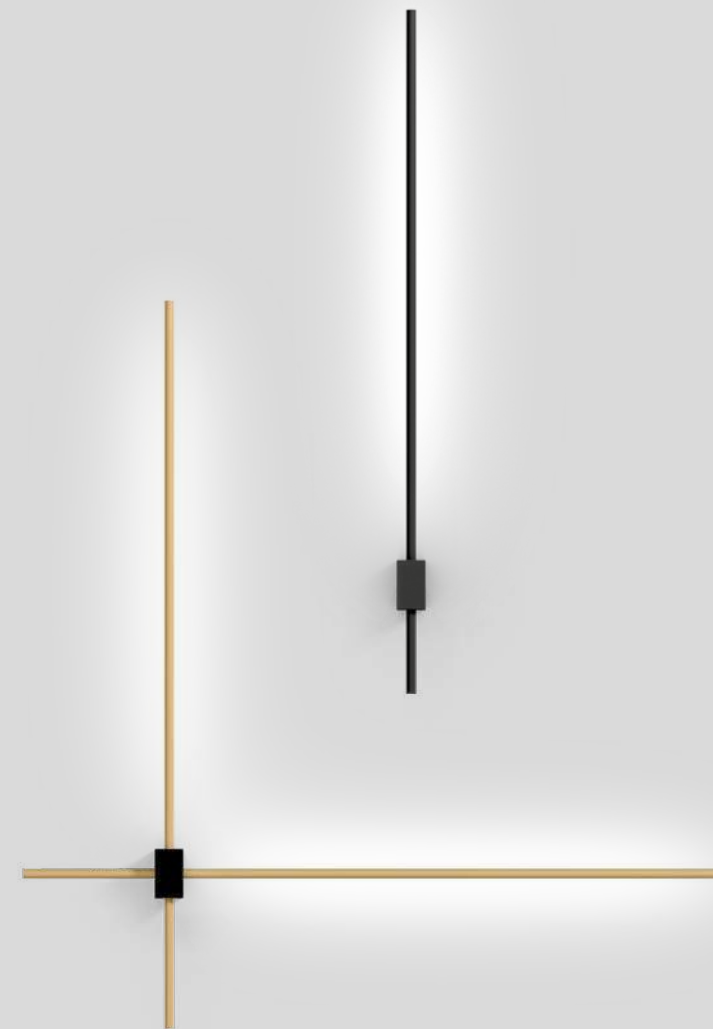

**OPTIONAL**

spacer 10mm for overlapping

	CODE
	900195B0

specs on page 816

**1.0**

LED PCB 6W | phase-cut dim  
220-240VAC | 50-60Hz | incl. driver  
aluminium | opal PMMA diffuser

IP20 SDCM3 L80|50K 0.15kg

	CODE
	370584CH_
	370584K_
	370584B_

	LIGHT COLOUR	LUMEN CRI	CODE
	2700K	350 >90	3
	3000K	380 >90	5

**4.0**

LED PCB 10W | phase-cut dim  
220-240VAC | 50-60Hz | incl. driver  
aluminium | opal PMMA diffuser

IP20 SDCM3 L80|50K 0.20kg

	CODE
	370884CH_
	370884B_

	LIGHT COLOUR	LUMEN CRI	CODE
	2700K	700 >90	3
	3000K	760 >90	5

FINLIN

Wall surface



reddot winner 2023



As awarded by The Chicago Athenaeum:  
Museum of Architecture and Design



277



385



657

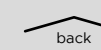

back



OFFICE WOESTIJNVIS | STUDIO BOITE VILVOORDE | BELGIUM

# FINLIN

Wall surface

reddot winner 2023

**2.0**

LED PCB 10W | phase-cut dim  
220-240VAC | 50-60Hz | incl. driver  
aluminium | opal PMMA diffuser

IP20 SDCM3 L80|50K 0.18kg

**3.0**

LED PCB 10W | phase-cut dim  
220-240VAC | 50-60Hz | incl. driver  
aluminium | opal PMMA diffuser

IP20 SDCM3 L80|50K 0.30kg

	<p>CODE</p> <p>370684CH_</p> <p>370684K_</p> <p>370684B_</p>
--	--

	<p>CODE</p> <p>370784CH_</p> <p>370784B_</p>
--	--

**OPTIONAL**

spacer 10mm for overlapping

	CODE	LIGHT COLOUR	LUMEN CRI	CODE		CODE	LIGHT COLOUR	LUMEN CRI	CODE
	900195B0	2700K	700 >90	3			2700K	700 >90	3
		3000K	760 >90	5			3000K	760 >90	5

specs on page 816

back



FINLIN

Wall surface



reddot winner 2023

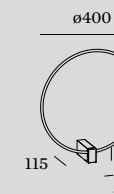

**1.0 ROUND**

LED PCB 13W | phase-cut dim  
220-240VAC | 50-60Hz | incl. driver  
aluminium | opal PMMA diffuser

IP20 SDCM3 L80|50K 0.32kg

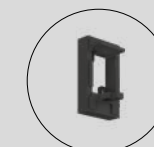

**OPTIONAL**

spacer 10mm for overlapping

900196B0  
specs on page 816

CODE	
	371184CH
	371184B

LIGHT COLOUR	LUMEN CRI	CODE
2700K	1180 >90	3
3000K	1280 >90	5

back



# FIL SPIN

Wall surface

new



251



383

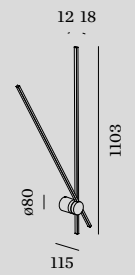
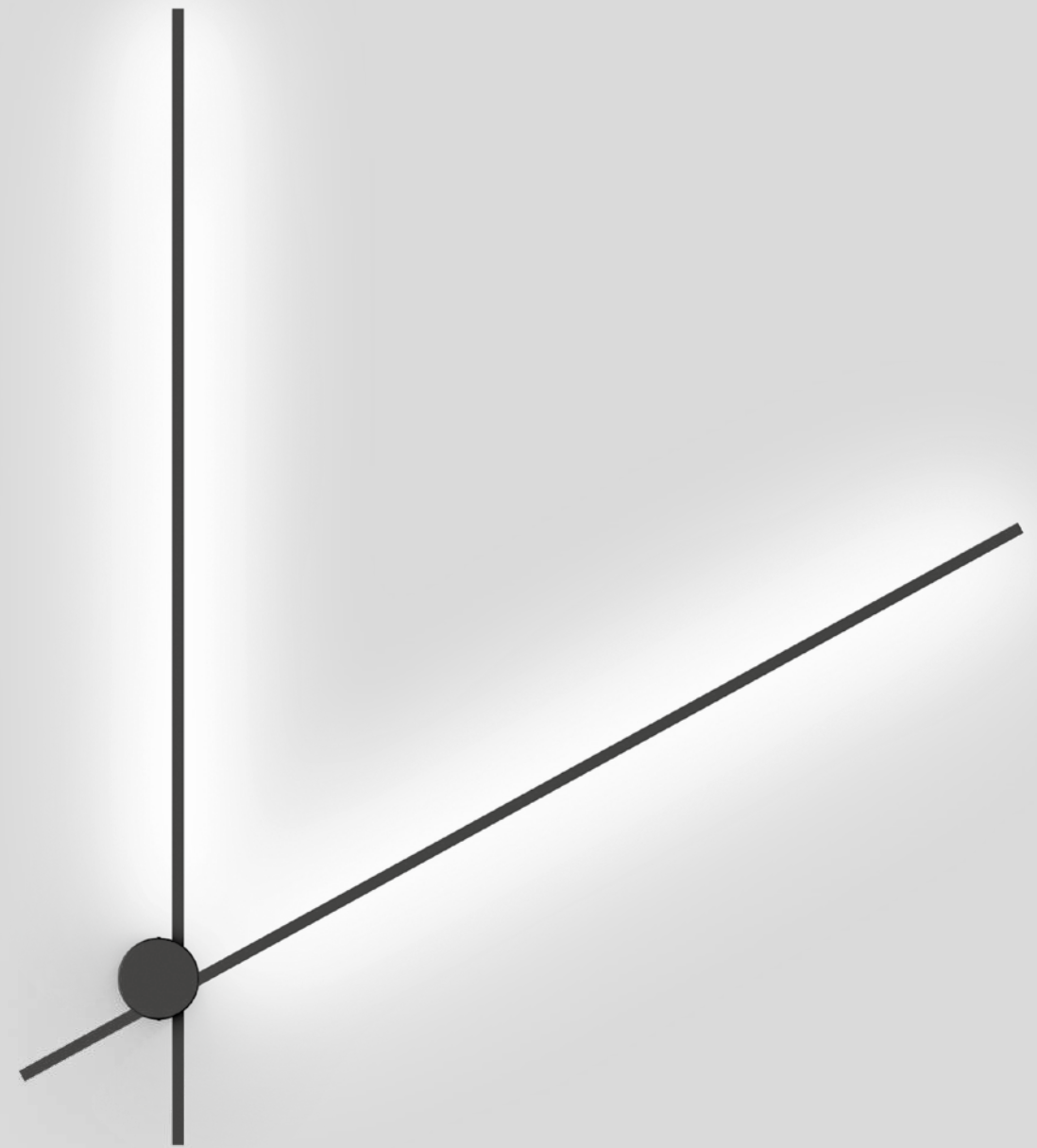

1.0

LED PCB 23W | phase-cut dim  
220-240VAC | 50-60Hz | incl. driver  
aluminium | indir. light

IP20 180° SDCM2 L80|50K 0.95kg

2700K | CRI >90 | 2x1050lm

CODE

254584B3

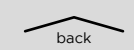

Rev. 001/2024-05

WEVER & DUCRÉ 614 — 615





SHOWROOM GRANDO KEUKENS SINT-MARTENS-LATEM | BELGIUM

# VENN

Wall surface



As awarded by The Chicago Athenaeum: Museum of Architecture and Design



261

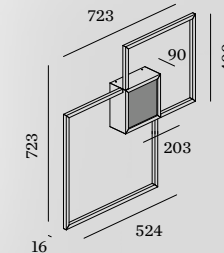
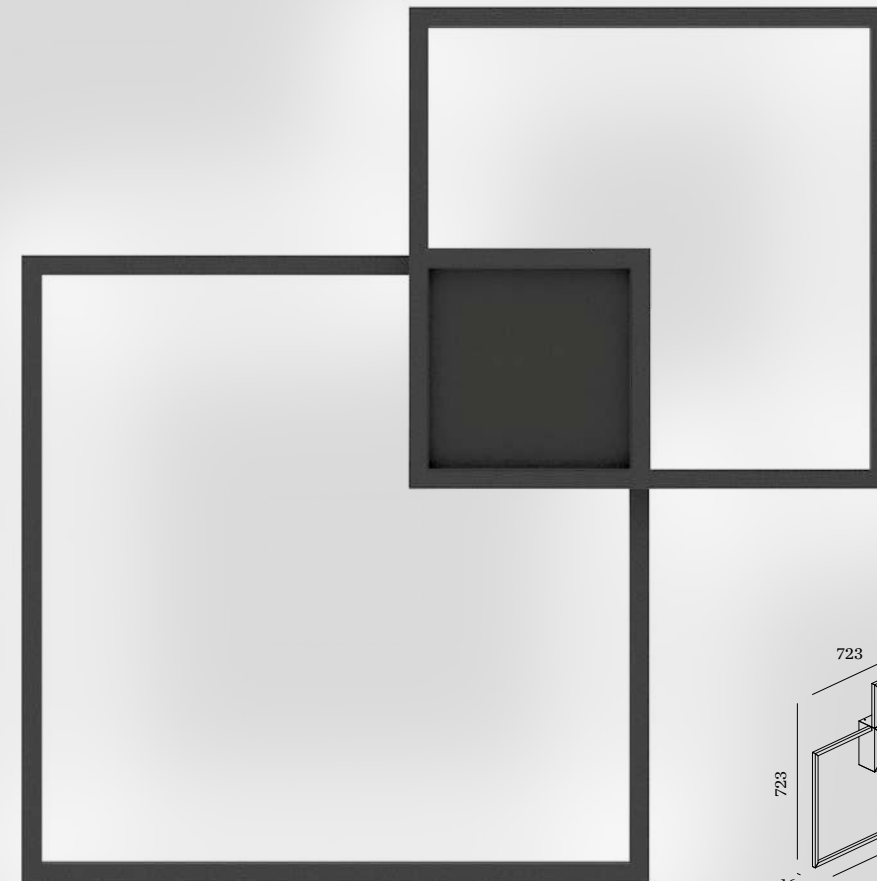

1.0

LED PCB 42W | phase-cut dim  
220-240VAC | 50-60Hz | incl. driver  
aluminium | opal PMMA cover  
indirect light

IP20 SDCM3 L70|55K 2.50kg

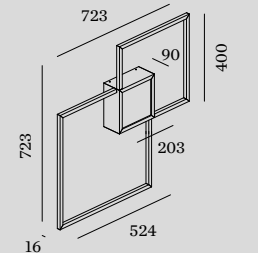

2.0

LED PCB 49W | phase-cut dim  
220-240VAC | 50-60Hz | incl. driver  
aluminium | opal PMMA cover  
dir./indir. light

IP20 SDCM3 L70|55K 2.50kg

CODE
149184W_
149184Q_
149184B_

LIGHT COLOUR	LUMEN CRI	CODE
2700K	3410 >80	2
3000K	3510 >80	4

CODE
149284W_
149284Q_
149284B_

LIGHT COLOUR	LUMEN CRI	CODE
2700K	480/3440 >80	2
3000K	495/3540 >80	4



CREATE YOUR OWN VENN  
weverducre.com/venn-configurator

Rev. 001/2024-05  
S&R CORNELISSEN

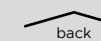

back



► DESIGN WITH LOVE



# SARA snooze

Wall surface

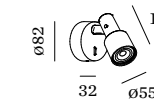

## 1.0

PAR16 max. 12W | GU10  
100-240VAC | 50-60Hz  
aluminium  
incl. switch on/off

IP20 0°-90°/330° 0.33kg

	CODE
	157320W0
	157320G0
	157320K0
	157320B0

## OPTIONAL

PAR16 6.5W | GU10

	CODE
2700K   460lm	901228W3
2700K   437lm	901228B3
3000K   500lm	901228W5
3000K   457lm	901228B5



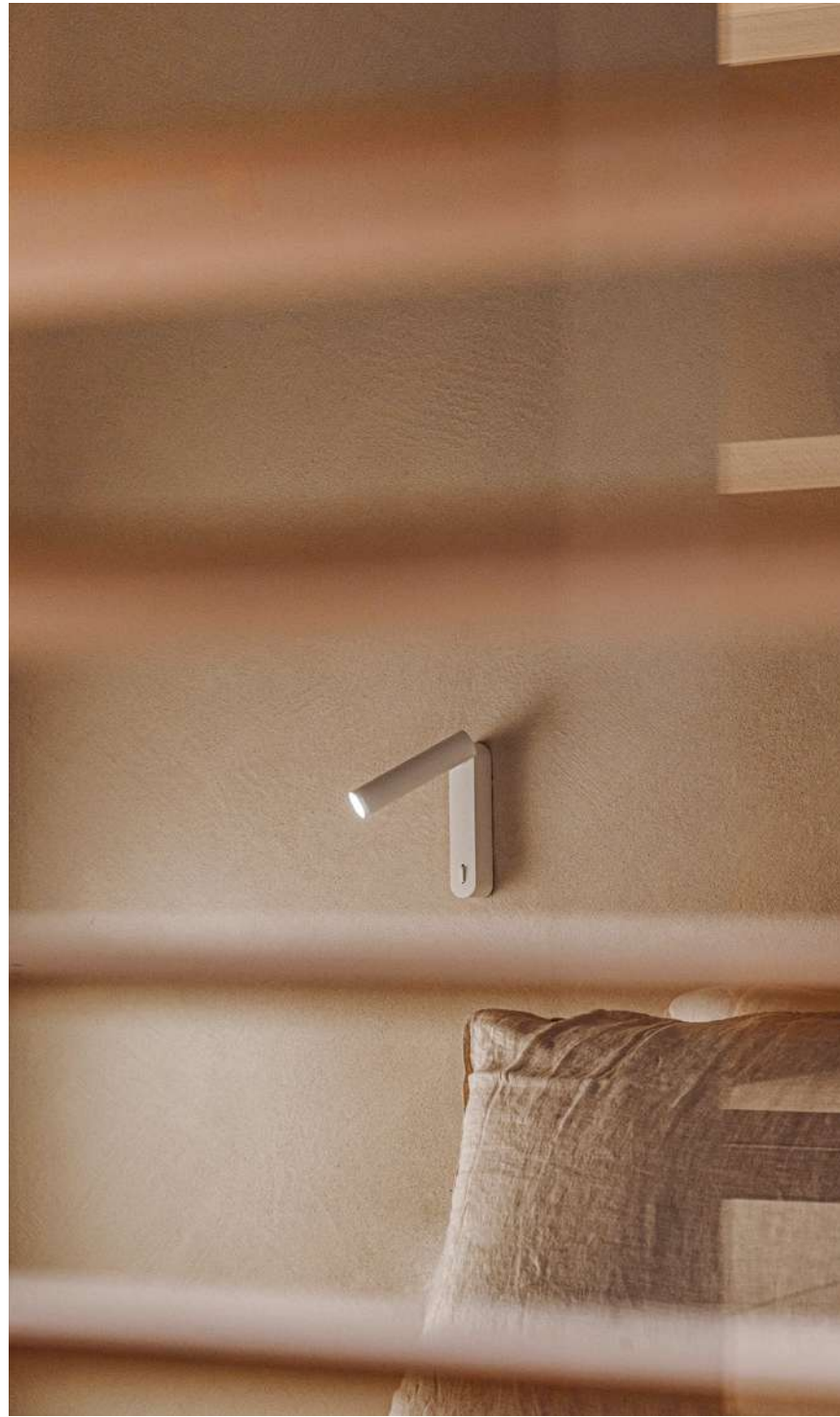

PRIVATE RESIDENCE | UNIQUE RENOVATIONS KNOCKE BELGIUM



# MATCH snooze

Wall surface



reddot winner 2023



As awarded by The Chicago Athenaeum:  
Museum of Architecture and Design

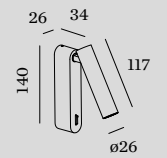

## 1.0

LED LED COB 5W  
220-240VAC | 50-60Hz | incl. driver  
aluminium  
incl. switch on/off

IP20 0°-90°|350° A 30° SDCM2 L80|50K 0.24kg

### CODE

177353W\_

177353B\_

LIGHT COLOUR	LUMEN CRI	CODE
2700K	310 >90	3
3000K	330 >90	5

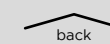



PRIVATE RESIDENCE | NORDIC STANDARD SPAIN

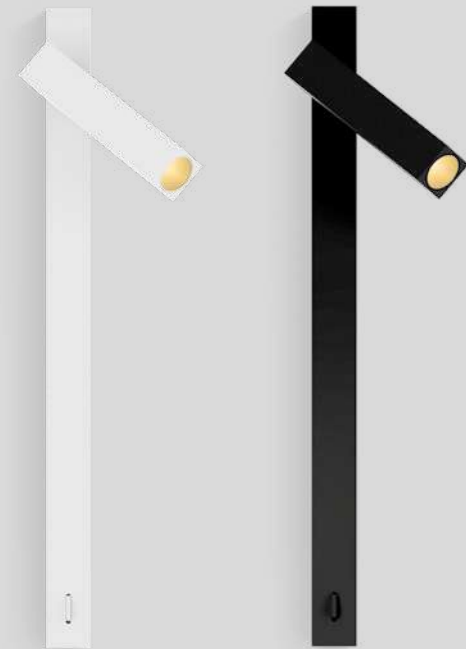

# MICK snooze

Wall surface



reddot winner 2020  
lighting design



237



309

511

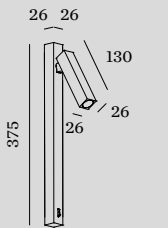

## 1.0

LED COB 8W  
220-240VAC | 50-60Hz | incl. driver  
aluminium  
incl. switch on/off

IP20 0°-90°|350°  $\Delta$  23° SDCM2 L80|50K 0.39kg

CODE

159643J\_

159643K\_

LIGHT COLOUR	LUMEN CRI	CODE
2700K	180 >90	3
3000K	200 >90	5

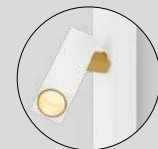



# MICK

Wall surface



reddot winner 2020  
lighting design



237



309

511

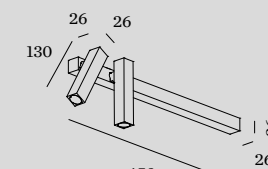
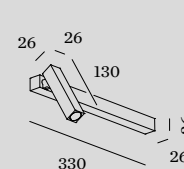
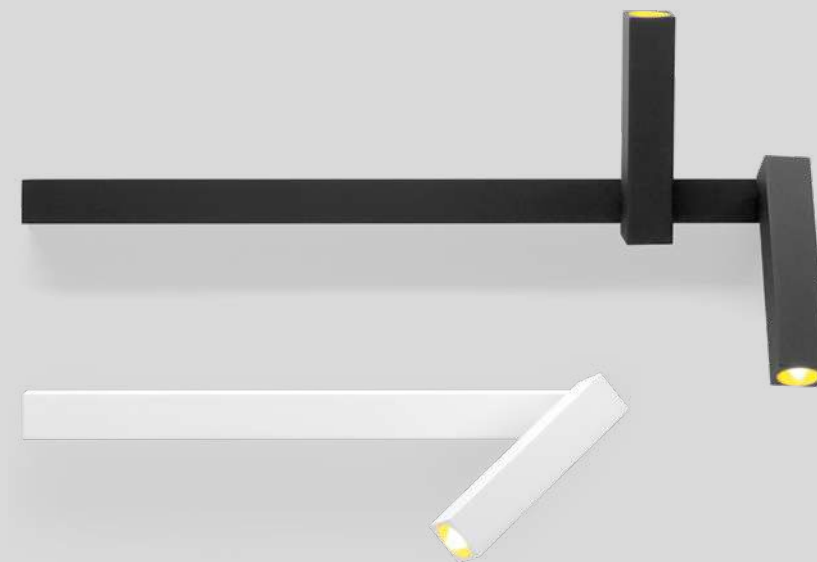

## 1.0

LED COB 8W | phase-cut dim  
220-240VAC | 50-60Hz | incl. driver  
aluminium

⊕ IP20 0°-90°/350° ↗ 23° SDCM2 L80|50K 0.35kg

## 2.0

LED COB 14W | phase-cut dim  
220-240VAC | 50-60Hz | incl. driver  
aluminium

⊕ IP20 0°-90°/350° ↗ 23° SDCM2 L80|50K 0.62kg

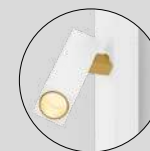

CODE		
		159344J_
		159344K_

LIGHT COLOUR	LUMEN CRI	CODE
2700K	225 >90	3
3000K	245 >90	5

CODE		
		159244J_
		159244K_

LIGHT COLOUR	LUMEN CRI	CODE
2700K	2x225 >90	3
3000K	2x245 >90	5



# DOMINO

Wall surface

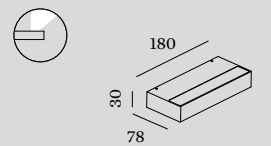

## 1.0

LED PCB 14W | phase-cut dim  
220-240VAC | 50-60Hz | incl. driver  
aluminium

IP20 SDCM3 L80|60K 0.69kg

### CODE

	3371A4W_
	3371A4B_

LIGHT COLOUR	LUMEN CRI	CODE
2700K	1060 >80	2
3000K	1175 >80	4

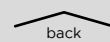



# SCAVA

Wall surface

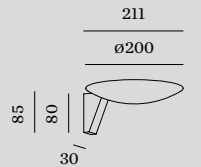
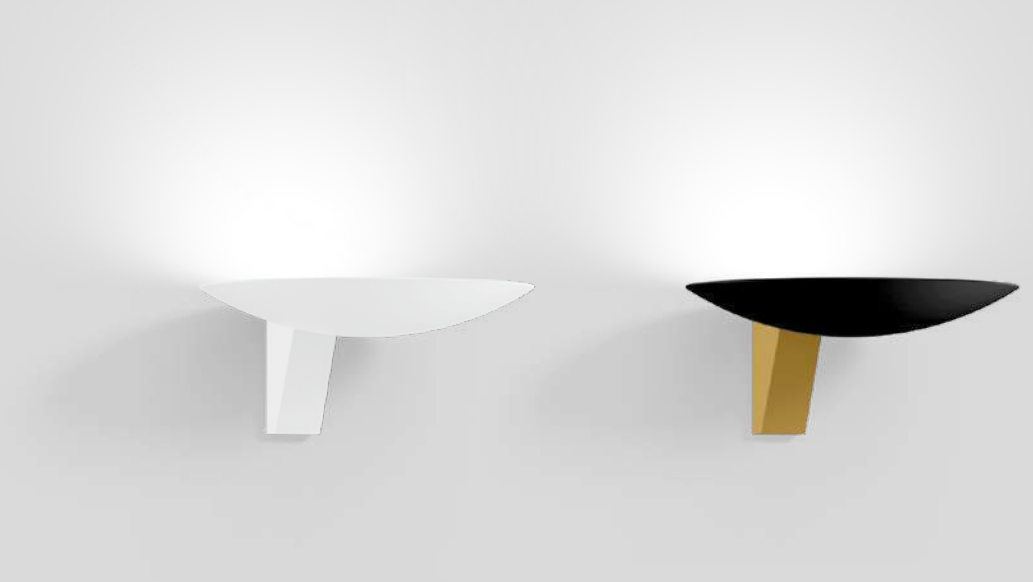

## 1.0

LED PCB 25W | phase-cut dim  
220-240VAC | 50-60Hz  
aluminium | opal PC cover

IP20 SDCM3 L80|50K 0.42kg

	CODE
	350188W_
	350188GB_
	350188B_

LIGHT COLOUR	LUMEN CRI	CODE
2700K	1880 >90	3
3000K	1960 >90	5

Rev.001/2024-05

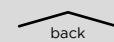

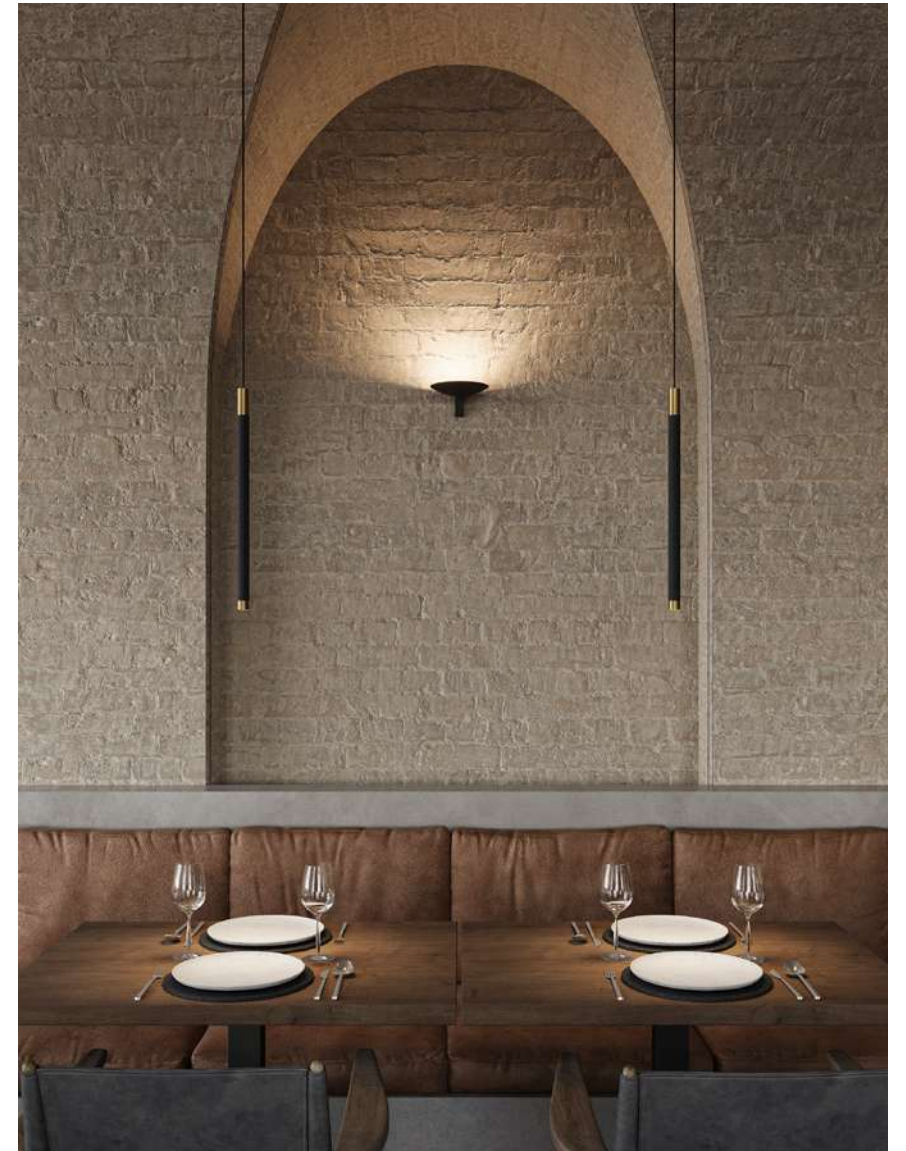



# PERLEZ IP44

Wall surface

new



155



255 | 259 | 279

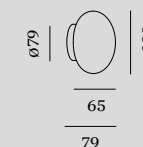

## 1.0

LED COB 8W | phase-cut dim  
220-240VAC | 50-60Hz | incl. driver  
aluminium | opal glass  
mirror thickness 3-6mm

IP44 SDCM3 L80|50K 0.38kg

50-52

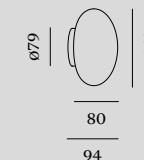

## 2.0

LED COB 8W | phase-cut dim  
220-240VAC | 50-60Hz | incl. driver  
aluminium | opal glass  
mirror thickness 3-6mm

IP44 SDCM3 L80|50K 0.48kg

50-52

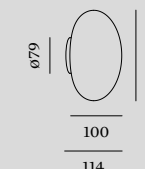

## 3.0

LED COB 8W | phase-cut dim  
220-240VAC | 50-60Hz | incl. driver  
aluminium | opal glass  
mirror thickness 3-6mm

IP44 SDCM3 L80|50K 0.66kg

50-52

CODE			
192484W_			
LIGHT COLOUR	LUMEN CRI	CODE	
3000K	540 >95	5	
4000K	570 >95	7	

CODE			
192584W_			
LIGHT COLOUR	LUMEN CRI	CODE	
3000K	590 >95	5	
4000K	620 >95	7	

CODE			
192684W_			
LIGHT COLOUR	LUMEN CRI	CODE	
3000K	650 >95	5	
4000K	680 >95	7	

back



# PERLEZ CLIP IP44

Wall surface

new

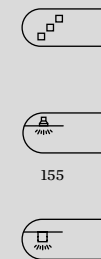

255 | 259 | 279

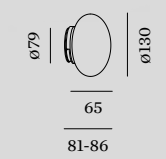
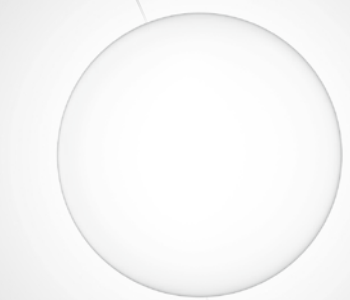

## 1.0 CLIP

LED COB 8W | phase-cut dim  
220-240VAC | 50-60Hz | incl. driver  
aluminium | opal glass  
mirror thickness 3-6mm  
slides over the mirror

IP44 SDCM3 L80|50K 0.46kg

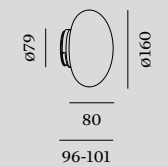

## 2.0 CLIP

LED COB 8W | phase-cut dim  
220-240VAC | 50-60Hz | incl. driver  
aluminium | opal glass  
mirror thickness 3-6mm  
slides over the mirror

IP44 SDCM3 L80|50K 0.56kg

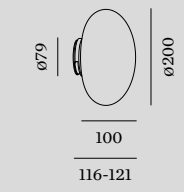

## 3.0 CLIP

LED COB 8W | phase-cut dim  
220-240VAC | 50-60Hz | incl. driver  
aluminium | opal glass  
mirror thickness 3-6mm  
slides over the mirror

IP44 SDCM3 L80|50K 0.74g

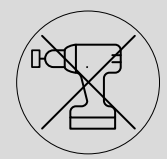

CODE			
392484W_			
LIGHT COLOUR	LUMEN CRI	CODE	
3000K	540 >95	5	
4000K	570 >95	7	

CODE			
392584W_			
LIGHT COLOUR	LUMEN CRI	CODE	
3000K	590 >95	5	
4000K	620 >95	7	

CODE			
392684W_			
LIGHT COLOUR	LUMEN CRI	CODE	
3000K	650 >95	5	
4000K	680 >95	7	



# RUVI IP44

Wall surface

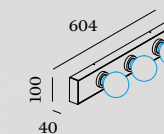

## 3.0

3x G95 max. 12W | E27  
220-240VAC | 50-60Hz  
aluminium

IP44 1.48kg

CODE

3673EOLB0

## OPTIONAL

G95 11.2W | E27 | phase-cut dim | opal  
CODE

2700K | 1100lm 9003E154

G95 5.6W | E27 | phase-cut dim  
filament | silver mirror

CODE

2700K | 464lm 9003E157

G95 5.6W | E27 | phase-cut dim  
filament | gold mirror

CODE

2700K | 464lm 9003E142

back



# MIRBA IP44

Wall surface

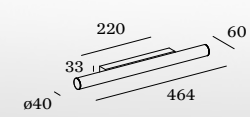

## 1.0

LED PCB 4/6W | phase-cut dim  
220-240VAC | 50-60Hz  
aluminium | opal PMMA  
output selector

⊕ IP44 SDCM3 L80|50K 0.51kg

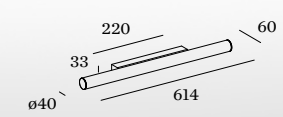

## 2.0

LED PCB 6/9W | phase-cut dim  
220-240VAC | 50-60Hz  
aluminium | opal PMMA  
output selector

⊕ IP44 SDCM3 L80|50K 0.65kg

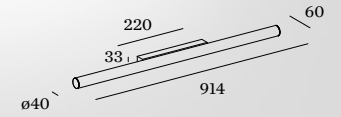

## 3.0

LED PCB 8/12W | phase-cut dim  
220-240VAC | 50-60Hz  
aluminium | opal PMMA  
output selector

⊕ IP44 SDCM3 L80|50K 0.69kg

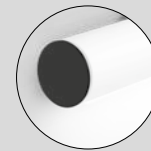

CODE	
	328188W_
	328188BW_

LIGHT COLOUR	LUMEN CRI	CODE
2700K	L 375/H 640 >90	3
3000K	L 400/H 670 >90	5

CODE	
	328288W_
	328288BW_

LIGHT COLOUR	LUMEN CRI	CODE
2700K	L 530/H 920 >90	3
3000K	L 570/H 960 >90	5

CODE	
	328388W_
	328388BW_

LIGHT COLOUR	LUMEN CRI	CODE
2700K	L 730/H 1290 >90	3
3000K	L 770/H 1350 >90	5

back



# MIRBI long IP44

Wall surface



157



283

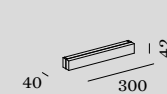

## 1.0

LED PCB 5/7W | phase-cut dim  
220-240VAC | 50-60Hz  
aluminium | opal PMMA  
output selector

⊕ IP44 SDCM3 L80|60K 0.72kg

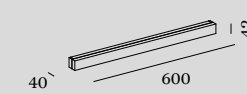

## 2.0

LED PCB 7/12W | phase-cut dim  
220-240VAC | 50-60Hz  
aluminium | opal PMMA  
output selector

⊕ IP44 SDCM3 L80|60K 1.53kg

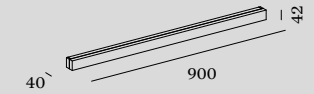

## 3.0

LED PCB 12/18W | phase-cut dim  
220-240VAC | 50-60Hz  
aluminium | opal PMMA  
output selector

⊕ IP44 SDCM3 L80|60K 2.42kg



clear + opal  
PMMA

CODE			CODE			CODE		
329188W_			329288W_			329388W_		
LIGHT COLOUR	LUMEN CRI	CODE	LIGHT COLOUR	LUMEN CRI	CODE	LIGHT COLOUR	LUMEN CRI	CODE
2700K	250/410 >90	3	2700K	320/550 >90	3	2700K	550/750 >90	3
3000K	280/460 >90	5	3000K	365/620 >90	5	3000K	610/840 >90	5

back

## PORTABLE LUMINAIRES



**REVER DINING**  
655

## TABLE



**DRO**  
647



**DRO**  
649



**MIRRO**  
651



**ROOMOR**  
653

## FLOOR

*new*



**FINLIN**  
657

*new*



**MATCH**  
659



**DRO**  
647



**DRO**  
661



**MIRRO**  
663



**ROOMOR**  
665



# DRO

Table / Floor

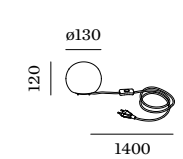
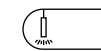
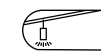
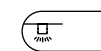
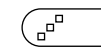

## 1.0

QT14 max. 5W | G9  
220-240VAC | 50-60Hz  
aluminium  
artisanal Italian hand blown glass  
cable plug with switch

IP20 0.41kg

CODE  
6421G0WB0

### OPTIONAL

QT14 3W | G9 | phase-cut dim | clear  
CODE  
2700K | 300lm 9010G802  
3000K | 280lm 9010G804

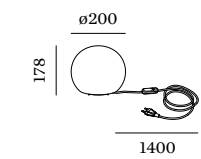

## 2.0

C35 max. 6W | E14 | dimmable  
220-240VAC | 50-60Hz  
aluminium  
artisanal Italian hand blown glass  
cable plug with dimmer switch

IP20 0.97kg

CODE  
6422C0WB0

### OPTIONAL

C35 5.5W | E14 | phase-cut dim  
opal  
CODE  
2700K | 450lm 9003C103

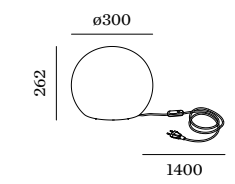

## 3.0

A60 max. 12W | E27 | dimmable  
220-240VAC | 50-60Hz  
aluminium  
artisanal Italian hand blown glass  
cable plug with dimmer switch

IP20 1.97kg

CODE  
6423E0WB0

### OPTIONAL

A60 9W | E27 | phase-cut dim  
opal  
CODE  
2700K | 800lm 9003E152

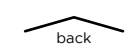

back



# DRO

Table

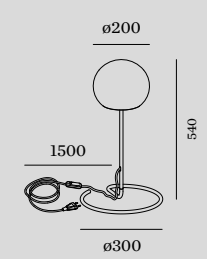

## 2.0

⦿ C35 max. 6W | E14 | dimmable  
220-240VAC | 50-60Hz  
aluminium | steel  
artisanal Italian hand blown glass  
cable plug with dimmer switch

☐ IP20 2.70kg

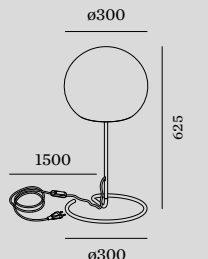

## 3.0

⦿ A60 max. 12W | E27 | dimmable  
220-240VAC | 50-60Hz  
aluminium | steel  
artisanal Italian hand blown glass  
cable plug with dimmer switch

☐ IP20 3.80kg

CODE

6432COWB0

CODE

6433E0WB0

## OPTIONAL

C35 5.5W | E14 | phase-cut dim | opal  
CODE  
2700K | 450lm 9003C103

## OPTIONAL

A60 9W | E27 | phase-cut dim | opal  
CODE  
2700K | 800lm 9003E152



# MIRRO

Table



267



431



581

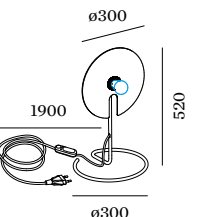

### 1.0

A60 max. 15W | E27 | dimmable  
220-240VAC | 50-60Hz  
aluminium | steel | one side  
reflective composite panel  
cable plug with dimmer switch

IP20 1.30kg

	CODE
	6301EOGB0
	6301EONB0
	6301EOLB0

### OPTIONAL

A60 5.5W | E27 | phase-cut dim  
gold mirror

	CODE
2700K   409lm	9003E139

A60 5.5W | E27 | phase-cut dim  
silver mirror

	CODE
2700K   409lm	9003E140





HOTEL LOPESAN | EMILIO PELLEJERO FARO | SPAIN



3H DRAFT



back

# ROOMOR

Table



reddot award 2019  
winner lighting design

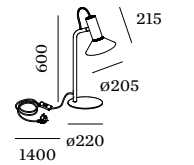

## 1.1

PAR16 max. 15W | GU10  
100-240VAC | 50-60Hz  
aluminium | steel  
cable plug with hand switch

IP20 0°-45° | 0°-30° 2.35kg

### CODE

GG1	637120GG1
RR1	637120RR1
BK1	637120BK1
BB1	637120BB1

### OPTIONAL

PAR16 6.5W | GU10

	CODE
2700K   460lm	901228W3
2700K   437lm	901228B3
3000K   500lm	901228W5
3000K   457lm	901228B5





DET GLADE VANVID | SIMON SJØGAARD | ANKER & CO ODENSE | DENMARK

# REVER DINING

Table



As awarded by The Chicago Athenaeum: Museum of Architecture and Design

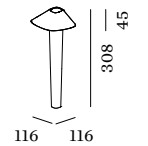

## ALWAYS USE



flat metal plate to add to REVER DINING with magnetic fixation suitable to put under the table cloth

plate colours

	CODE
	90019163
	90019164



single metal charging tray to add to REVER DINING with magnetic fixation

tray colours

	CODE
	90019175
	90019165
	90019166

## 1.0

LED 1.5W | touch dim  
magnetic pole with optional base  
rechargeable li-ion battery  
incl. 1.5m USB charging cable  
lights up to 8 hours  
zink alloy | PMMA

IP23 SDCM3 L80I60K 0.80kg

lamp body

	CODE
	655186Q_
	655186B_

LIGHT COLOUR	LUMEN CRI	CODE
2200K	70 >80	1

lamp body

	CODE
	655186Q_
	655186W_
	655186B_

LIGHT COLOUR	LUMEN CRI	CODE
2700K	85 >80	2

## OPTIONAL

multiple charging tray   up to 4 fixtures	CODE
	90018007

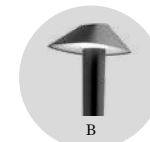

MARCELLO ZILIANI

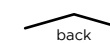

back



# FINLIN

Floor

new

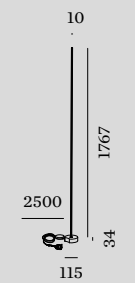
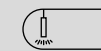
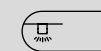
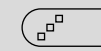

1.0

LED PCB 13W | dimmable  
220-240VAC | 50-60Hz | incl. driver  
aluminium | opal PMMA diffuser  
cable plug with dimmer switch

IP20 0°-10°/360° SDCM3 L80/50K 2.70kg

2700K | CRI >90 | 1380lm

	CODE
	470184W3
	470184B3

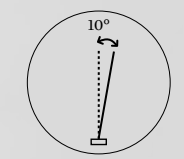

back





# MATCH

Floor

new

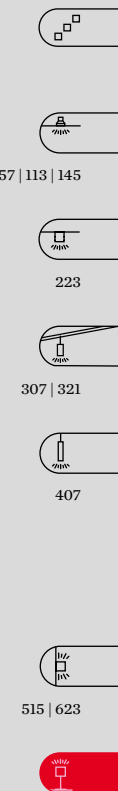

57 | 113 | 145

223

307 | 321

407

515 | 623

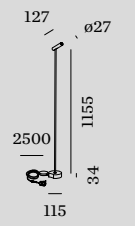

## 1.0

LED COB 18W | dimmable  
 220-240VAC | 50-60Hz | incl. driver  
 aluminium  
 cable plug with dimmer switch

IP20 0°-10°/360°/0°-145° A-30° SDCM3 L80/50K 2.70kg

2700K | CRI >90 | 560lm

CODE

477154W3

477154B3

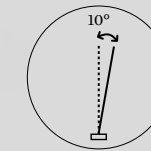
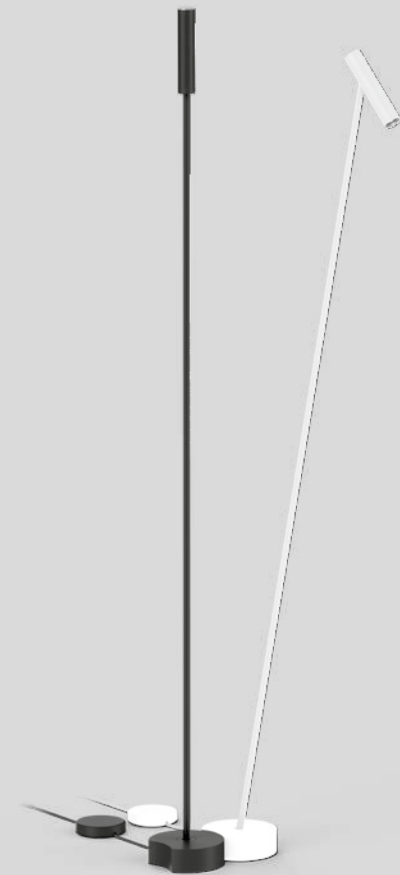

back



DRO

Floor

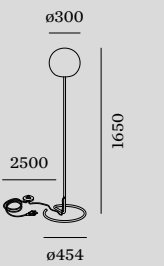

**3.0**

A60 max. 12W | E27 | dimmable  
 220-240VAC | 50-60Hz  
 aluminium | steel  
 artisanal Italian hand blown glass  
 cable plug with dimmer switch

IP20 8,25kg

CODE

6442E0WB0

**OPTIONAL**

A60 9W | E27 | phase-cut dim | opal  
 CODE  
 2700K | 800lm 9003E152



# MIRRO

Floor

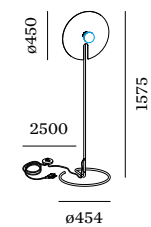
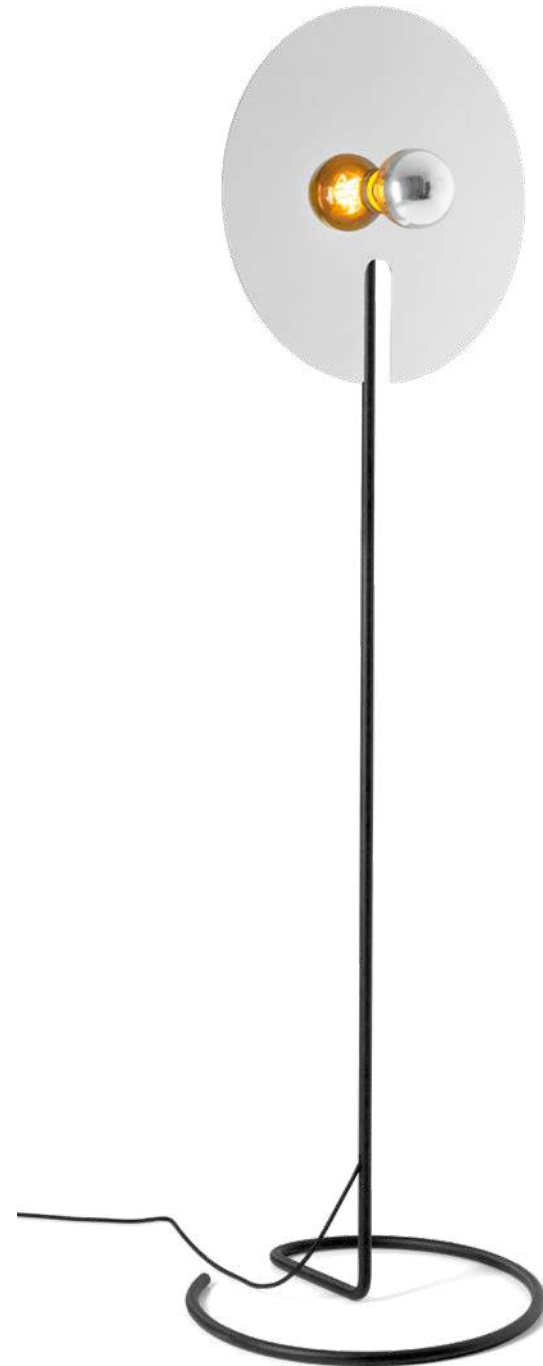

## 2.0

G95 max. 15W | E27 | dimmable  
220-240VAC | 50-60Hz  
aluminium | steel | one side  
reflective composite panel  
cable plug with dimmer switch

IP20 3.30kg

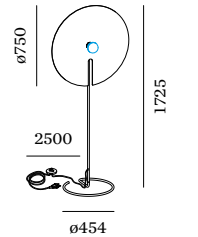

## 3.0

G95 max. 15W | E27 | dimmable  
220-240VAC | 50-60Hz  
aluminium | steel | one side  
reflective composite panel  
cable plug with dimmer switch

IP20 3.70kg

	CODE
	6311EOGB0
	6311EONB0
	6311EOLB0

### OPTIONAL

G95 5.1W/5.6W | E27 | phase-cut dim  
gold mirror

	CODE
2200K   371lm	9003E156
2700K   464lm	9003E142

G95 5.6W | E27 | phase-cut dim  
silver mirror

	CODE
2700K   464lm	9003E157

	CODE
	6312EOGB0
	6312EONB0
	6312EOLB0

### OPTIONAL

G95 5.1W/5.6W | E27 | phase-cut dim  
gold mirror

	CODE
2200K   371lm	9003E156
2700K   464lm	9003E142

G95 5.6W | E27 | phase-cut dim  
silver mirror

	CODE
2700K   464lm	9003E157

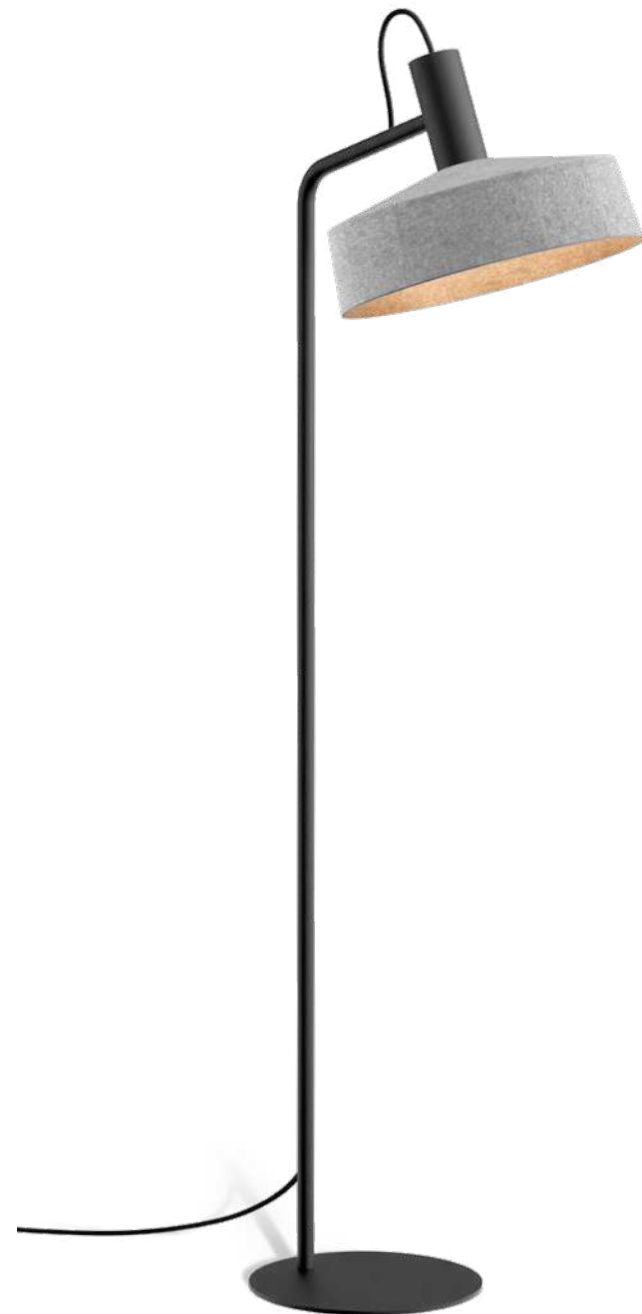

# ROOMOR

Floor



reddot award 2019  
winner lighting design

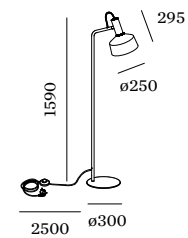

### 1.2

PAR16 max. 15W | GU10  
100-240VAC | 50-60Hz  
aluminium | steel | grey felt  
cable with floor switch

⊕ IP20 0°-45°|0°-30° 6.05kg|5.90kg

CODE	
	638120BF2
	638120BK2
	638120BB2

### OPTIONAL

PAR16 6.5W | GU10 | phase-cut dim

CODE	
	2700K   437lm 901228B3
	3000K   457lm 901228B5

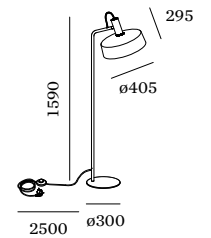

### 1.3

PAR16 max. 15W | GU10  
100-240VAC | 50-60Hz  
aluminium | steel | grey felt  
cable with floor switch

⊕ IP20 0°-45°|0°-30° 6.54kg|6.39kg

CODE	
	638120BF3
	638120BK3
	638120BB3

### OPTIONAL

PAR16 6.5W | GU10 | phase-cut dim

CODE	
	2700K   437lm 901228B3
	3000K   457lm 901228B5

# *Outdoor*

In one of those late nights, we're glad to have outdoor lighting showing us the safe way home. But not only that: architectural details and even house numbers will become eye-catchers in the right LED light.

# Ceiling recessed

669 – 679



RECESSED



**DEEP BIJOU IP65**  
671



*new*  
**DEEP PETIT IP65**  
673



**DEEP IP65**  
675



**TAIO IP65**  
677



**INTRA**  
679



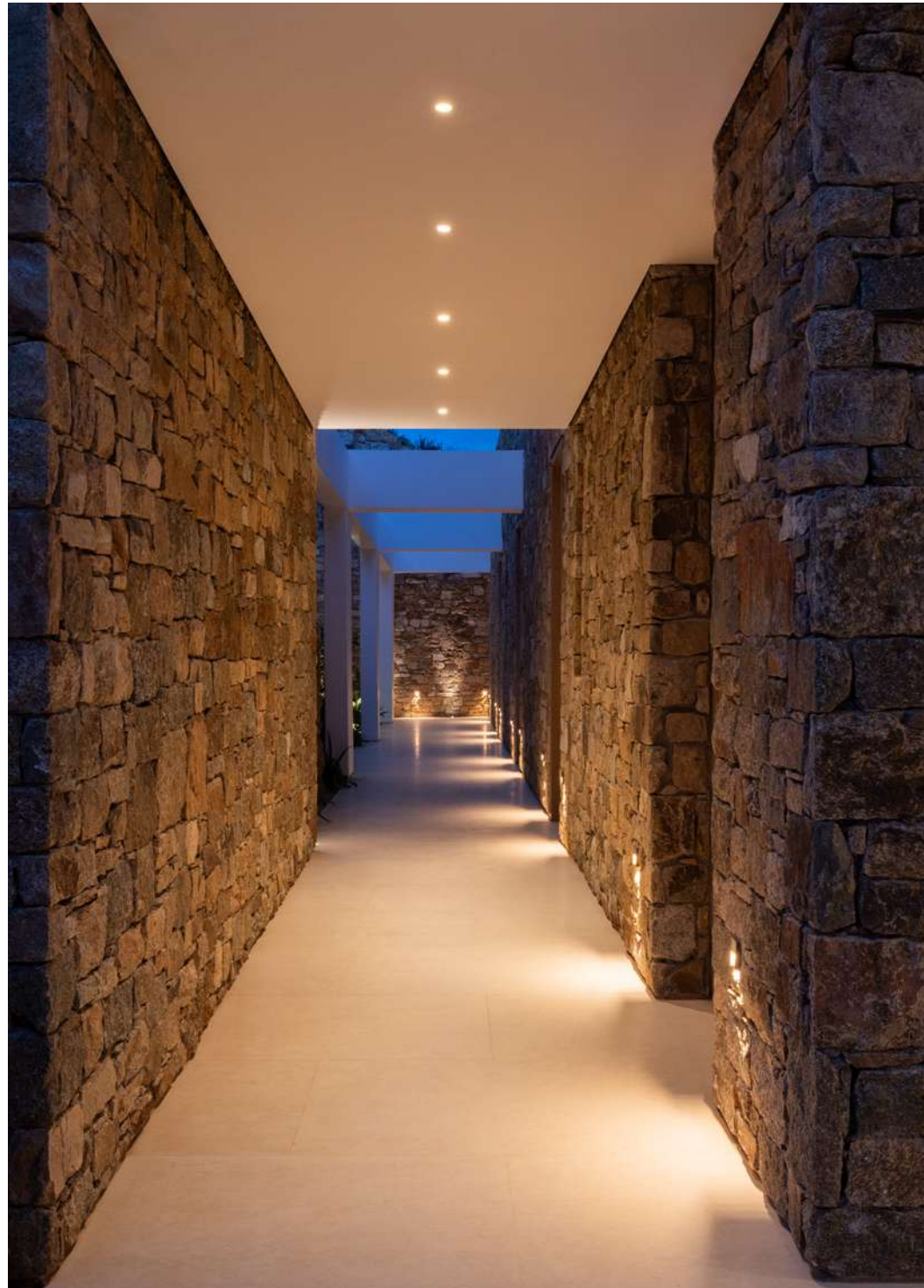

PRIVATE RESIDENCE GREECE



**BLADE SPRING VERSIONS ONLINE**  
[weverducre.com/more-deep-bijou-ip65](http://weverducre.com/more-deep-bijou-ip65)



# DEEP bijou IP65

Outdoor  
 Ceiling recessed



## 1.0

LED COB 4W | 500mA | 8V  
 aluminium

IP65 30° SDCM2 L80|55K 0.09kg

wire springs 50-52 1.85 4-25

	CODE
	165361W_
	165361Q_
	165361B_

LIGHT COLOUR	LUMEN	CRI	CODE
2700K	470	>90	3
3000K	495	>90	5

## ALWAYS USE

driver | IP67

	CODE
7W   500mA	90214301

more options and specs on page 808

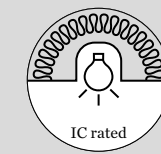

back



PRIVATE RESIDENCE GREECE

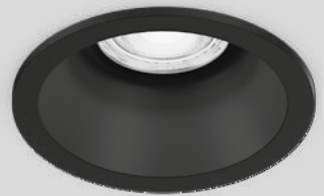

# DEEP petit IP65

Outdoor  
Ceiling recessed

new

63 | 139



## 1.0

LED COB 6W | 350mA | 17V  
aluminium

IP65 31° SDCM2 L80|50K 0.10kg

wire springs ⌀68-70 H.L.85 4-25

	CODE
White	153761W_
Black	153761B_

LIGHT COLOUR	LUMEN CRI	CODE
2700K	590 >90	3
3000K	610 >90	5

## ALWAYS USE

driver | 350mA | IP68

	CODE
17W	90213602

more options and specs on page 807

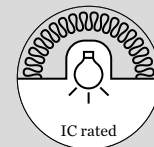



# DEEP IP65

Outdoor  
Ceiling recessed



65 | 151



## 1.0

LED COB 6/9W | 350/500mA | 17V aluminium

IP65 33° SDCM2 L80|55K 0.24kg

wire springs 86-89 L80 4-27

CODE

184161W\_

184161B\_

LIGHT COLOUR	LUMEN CRI	CODE
2700K	485/640 >90	3
3000K	510/690 >90	5

## ALWAYS USE

driver | IP68

CODE

17W | 350mA 90213602

24W | 500mA 90214702

more options and specs on page 807



BLADE SPRING VERSIONS

[weverducre.com/more-deep-ip65](https://weverducre.com/more-deep-ip65)

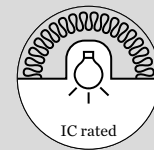

back



# TAIO IP65

Outdoor  
Ceiling recessed

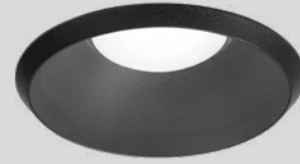

## 1.0

LED COB 6/9W | 350/500mA | 18V  
aluminium  
opal glass convex lens

IP65  $\angle$ 105° SDCM2 L80/55K 0.13kg

wire springs  $\varnothing$ 70 J L80  $\angle$ 4-27

	CODE
	180781W_
	180781G_
	180781B_

LIGHT COLOUR	LUMEN	CRI	CODE
2700K	340/455	>90	3
3000K	370/495	>90	5

## ALWAYS USE

driver | IP68

	CODE
17W   350mA	90213602
24W   500mA	90214702

more options and specs on page 807

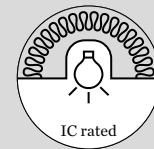

back



# INTRA

Outdoor  
Ceiling recessed

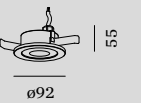
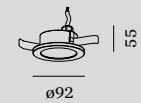

## 1.0 OPAL

LED PCB 7W | phase-cut dim  
220-240VAC | 50-60Hz  
aluminium | polyamide  
opal PMMA cover

IP65 SDCM3 L70|60K 0.15kg

blade springs ⌀76-79 | 170 | min. 8

3000K | CRI >90 | 410lm

CODE	
	733188W5
	733188A5
	733188B5

## 2.0 SPOT

LED PCB 7W | phase-cut dim  
220-240VAC | 50-60Hz  
aluminium | polyamide  
clear lens

IP65 45° SDCM3 L70|50K 0.15kg

blade springs ⌀76-79 | 170 | min. 8

3000K | CRI >90 | 560lm

CODE	
	733268W5
	733268A5
	733268B5

## SPOT LIGHTS



**TRAM**  
683



**TUBE**  
685



**TAIO**  
687



**RAY**  
689



**TRAIN**  
691



**TUBE CARRÉ**  
693



**BOX**  
695

## LUMINAIRES



**BLAS 1.0**  
697



**BLAS 2.0**  
697



**ROB**  
699



PRIVATE RESIDENCE BELGIUM



# TRAM

Outdoor  
Ceiling surface



**1.0**

LED COB 6W | phase-cut dim  
220-240VAC | 50-60Hz  
aluminium

IP65 | 36° | SDCM3 L70|55K 0.24kg

3000K | CRI >90 | 560lm

CODE	
	747768W5
	747768A5
	747768Q5
	747768B5

 back



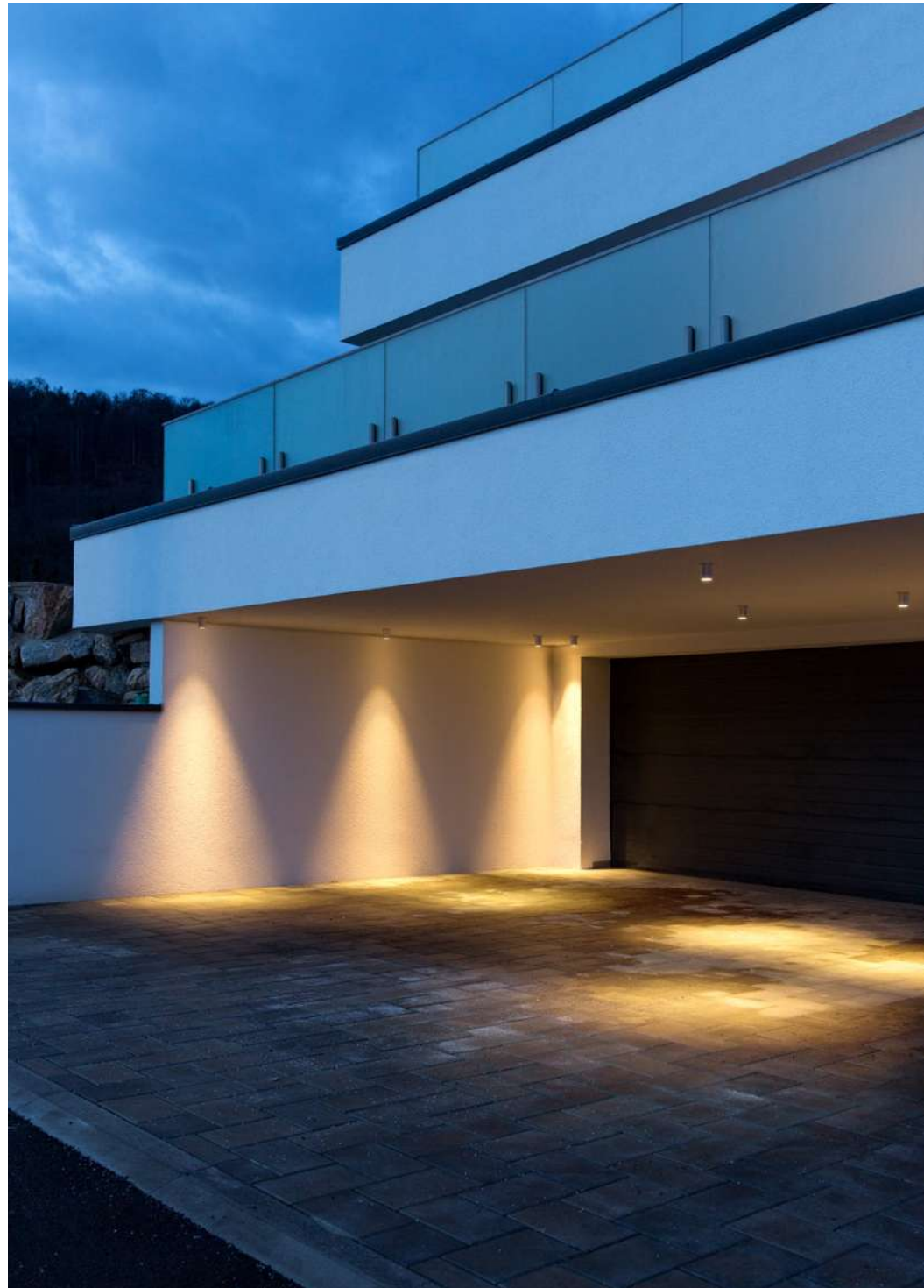

PRIVATE RESIDENCE AUSTRIA

# TUBE

Outdoor  
Ceiling surface

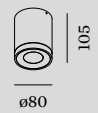
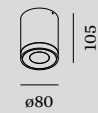

## 1.0 LED

LED LED COB 10W | phase-cut dim  
220-240VAC | 50-60Hz | incl. driver  
aluminium

IP65 36° SDCM3 L80|60K 0.56kg

3000K | CRI >90 | 630lm

CODE
734364W5
734364D5
734364A5
734364B5

## 1.0 PAR16

PAR16 max. 5W | GU10  
100-240VAC | 50-60Hz  
aluminium

IP65 0.49kg

CODE

734120W0
734120D0
734120A0
734120Q0
734120B0

## OPTIONAL

PAR16 4.3W | GU10

CODE
2700K   350lm 905227S2
3000K   350lm 905227S4

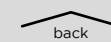

back



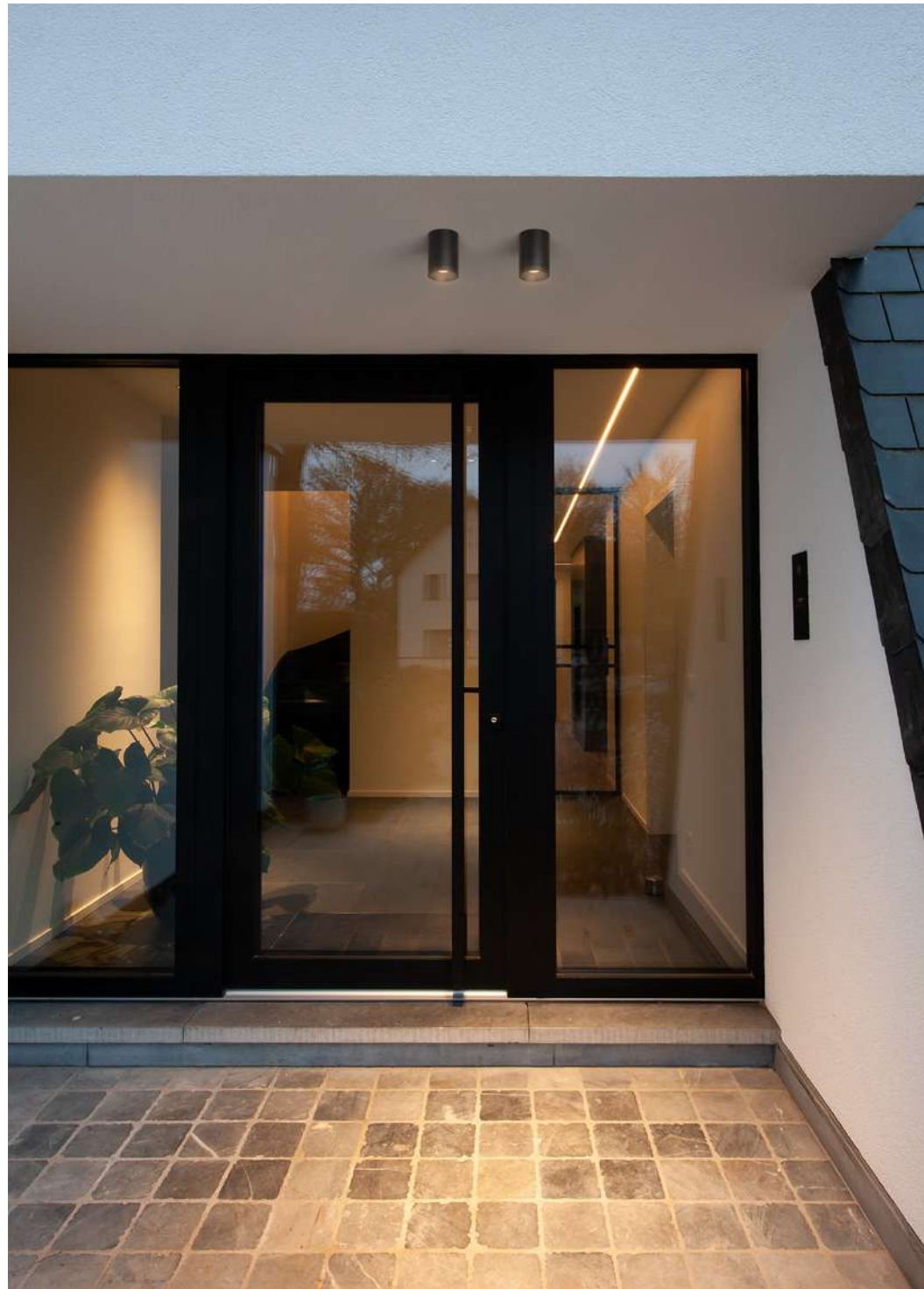

PRIVATE RESIDENCE BELGIUM



# TAIO

Outdoor  
Ceiling surface



1.0

LED COB 12W | phase-cut dim  
220-240VAC | 50-60Hz | incl. driver  
aluminium  
opal glass convex lens

IP65 | 105° SDCM2 L80|55K 0.53kg

CODE
180884W
180884A
180884Q
180884B

LIGHT COLOUR	LUMEN CRI	CODE
2700K	450 >90	3
3000K	480 >90	5



SHOP PHILMODE | ERIC FRANSSENS BEAUFAYS | BELGIUM



# RAY

Outdoor  
Ceiling surface



189



317 | 343 | 355



469



545

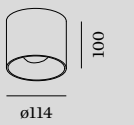

## 1.0

LED COB 8W | phase-cut dim  
220-240VAC | 50-60Hz  
aluminium

IP65 21° SDCM3 L70|50K 0.63kg



cover

### OPTIONAL

inner cover



CODE
911041W1
911041D1
911041A1
911041B1

CODE
735458W_
735458D_
735458A_
735458B_

LIGHT COLOUR	LUMEN   CRI	CODE
2700K	670   >90	3
3000K	700   >90	5
2000-3000K	470   >90	9



721

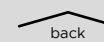



# TRAIN

Outdoor  
Ceiling surface

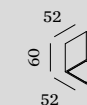
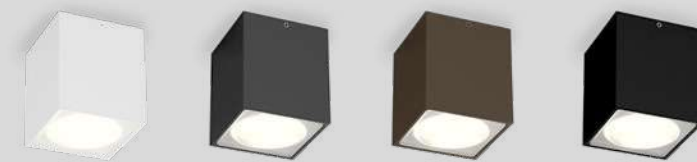

## 1.0

LED COB 6W | phase-cut dim  
220-240VAC | 50-60Hz  
aluminium

IP65 | 36° SDCM3 L70|55K 0.26kg

3000K | CRI >90 | 570lm

	CODE
	718668W5
	718668A5
	718668Q5
	718668B5



PRIVATE RESIDENCE | SPADO ARCHITECTS AUSTRIA

# TUBE CARRÉ

Outdoor  
Ceiling surface

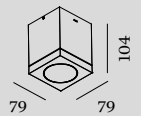
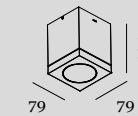

## 1.0 LED

LED COB 10W | phase-cut dim  
220-240VAC | 50-60Hz | incl. driver  
aluminium

IP65  $\Delta$  36° SDCM3 L80|60K 0.74kg

3000K | CRI >90 | 720lm

Color	CODE
	734464W5
	734464D5
	734464A5
	734464B5

## 1.0 PAR16

PAR16 max. 5W | GU10  
100-240VAC | 50-60Hz  
aluminium

IP65 0.67kg

CODE

	734220W0
	734220D0
	734220A0
	734220Q0
	734220B0

## OPTIONAL

PAR16 4.3W | GU10

Color	CODE
	2700K   350lm 905227S2
	3000K   350lm 905227S4

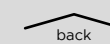



PRIVATE RESIDENCE FRANCE



BOX

Outdoor  
Ceiling surface

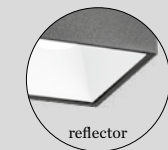
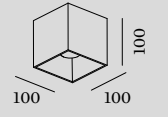

reflector

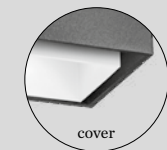

cover

1.0

LED COB 8W | phase-cut dim  
220-240VAC | 50-60Hz  
aluminium

IP65  $\Delta$  2P SDCM3 L70|50K 0.67kg

OPTIONAL

inner reflector

	CODE
	911211W1
	911211D1
	911211Q1
	911211B1

inner cover

	CODE
	911011W1
	911011D1
	911011Q1
	911011B1

	CODE
	735258W_
	735258D_
	735258A_
	735258Q_
	735258B_

LIGHT COLOUR	LUMEN	CRI	CODE
2700K	670	>90	3
3000K	700	>90	5
2000-3000K	470	>90	9

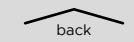

back



733



PRIVATE RESIDENCE | PETER RANEBURGER AUSTRIA

# BLAS

Outdoor  
Ceiling surface

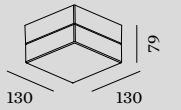
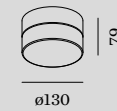

## 1.0

LED PCB 10W | phase-cut dim  
220-240VAC | 50-60Hz  
aluminium | clear and frosted  
glass

⊕ IP65 SDCM3 L80|50K 1.00kg

3000K | CRI >90 | 950lm

CODE

736387W5

736387B5

## 2.0

LED PCB 10W | phase-cut dim  
220-240VAC | 50-60Hz  
aluminium | clear and frosted  
glass

⊕ IP65 SDCM3 L80|50K 1.30kg

3000K | CRI >90 | 950lm

CODE

736487W5

736487B5



clear + frosted  
glass

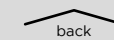

back



743



PRIVATE RESIDENCE BELGIUM

# ROB

Outdoor  
Ceiling surface



285

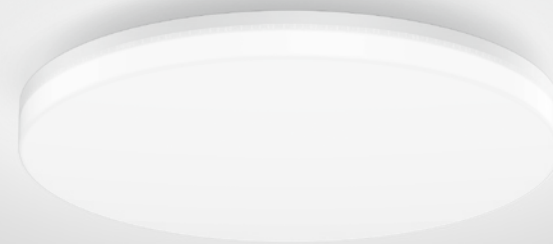

## 1.6

LED PCB 12W | phase-cut dim  
220-240VAC | 50-60Hz  
aluminium | opal PMMA cover

IP44 SDCM3 L80|60K 0.70kg

CODE  
701188W\_

LIGHT COLOUR	LUMEN CRI	CODE
2700K	1170 >90	3
3000K	1220 >90	5

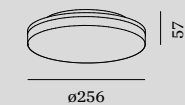

## 2.6

LED PCB 18W | phase-cut dim  
220-240VAC | 50-60Hz  
aluminium | opal PMMA cover

IP44 SDCM3 L80|60K 1.20kg

CODE  
701288W\_

LIGHT COLOUR	LUMEN CRI	CODE
2700K	1800 >90	3
3000K	1810 >90	5

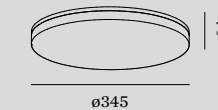

## 3.5

LED PCB 32W | phase-cut dim  
220-240VAC | 50-60Hz  
aluminium | opal PMMA cover

IP44 SDCM3 L80|60K 1.90kg

CODE  
701388W\_

LIGHT COLOUR	LUMEN CRI	CODE
2700K	3340 >90	3
3000K	3360 >90	5

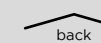

## RECESSED



**RETO 0.8**  
703



**RETO 1.3**  
703



**RETO 2.0**  
705



**ORIS 0.7**  
707



**ORIS 2.0**  
707



**ORIS 0.8**  
709



**ORIS 1.3**  
709



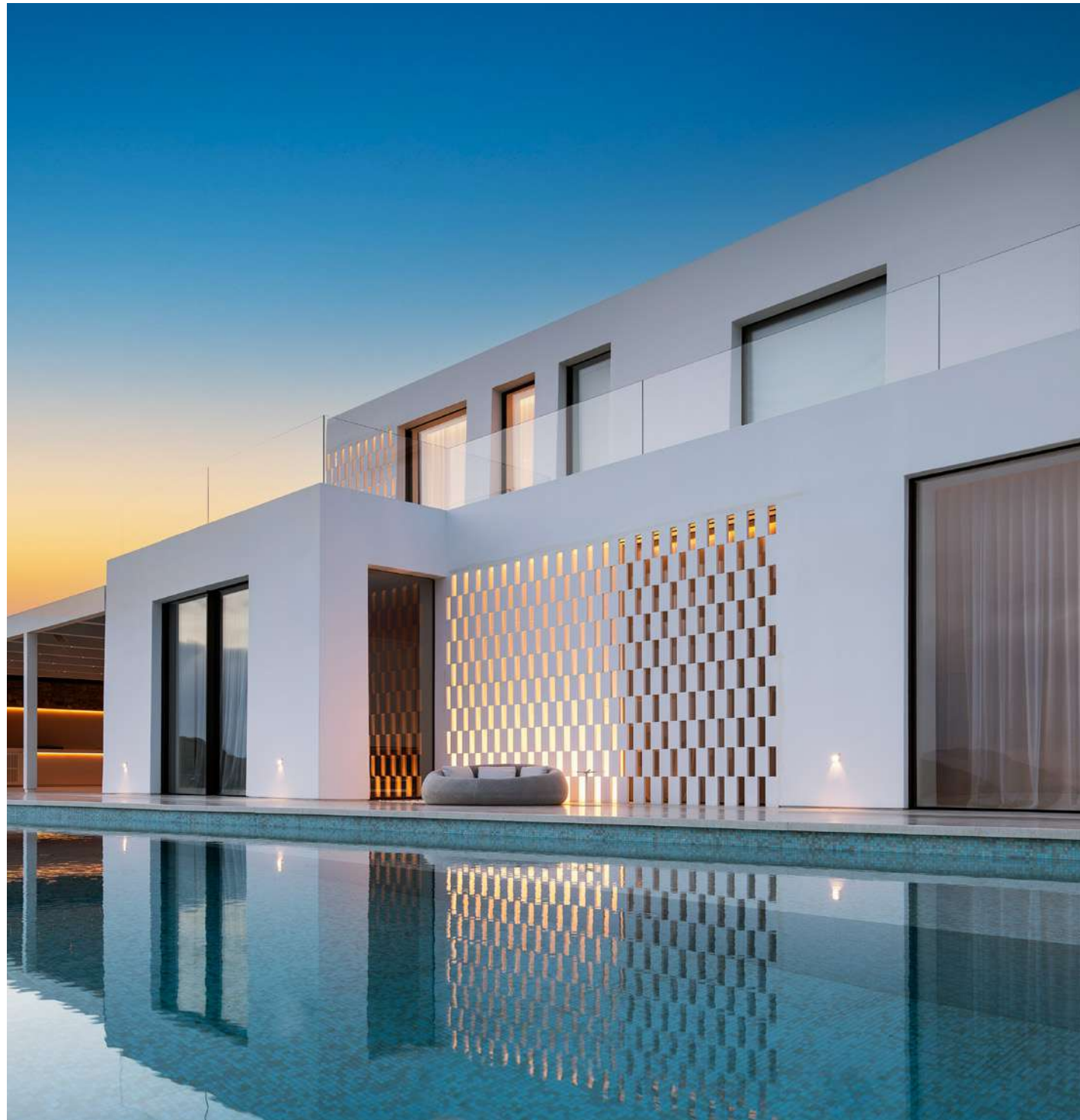

PRIVATE RESIDENCE GREECE

# RETO

Outdoor  
Wall recessed

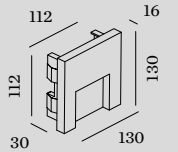
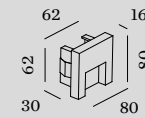

## 0.8

LED PCB 3W | const. volt. | 24V  
aluminium

IP65 SDCM3 L80|50K 0.24kg

66x66 1.40 min. 12

3000K | CRI >90 | 80lm

	CODE
	7451A2A5
	7451A2Q5
	7451A2B5

## ALWAYS USE

driver | IP67

	CODE
24V   35W	90212802
24V   100W	90212903

specs on page 810

## OPTIONAL

recessed housing incl. plasterkit

	CODE
	90012047

concrete housing

	CODE
	90012046

## 1.3

LED PCB 5W | const. volt. | 24V  
aluminium

IP65 SDCM3 L80|50K 0.42kg

115x117 1.40 min. 12

3000K | CRI >90 | 160lm

	CODE
	7452A2A5
	7452A2Q5
	7452A2B5

## ALWAYS USE

driver | IP67

	CODE
24V   35W	90212802
24V   100W	90212903

specs on page 810

## OPTIONAL

recessed housing incl. plasterkit

	CODE
	90012041

concrete housing

	CODE
	90012040

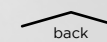
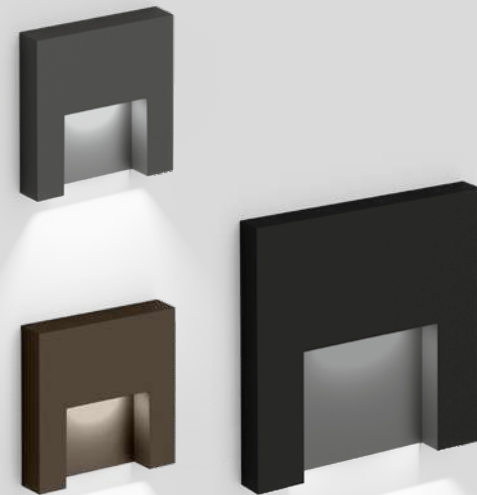

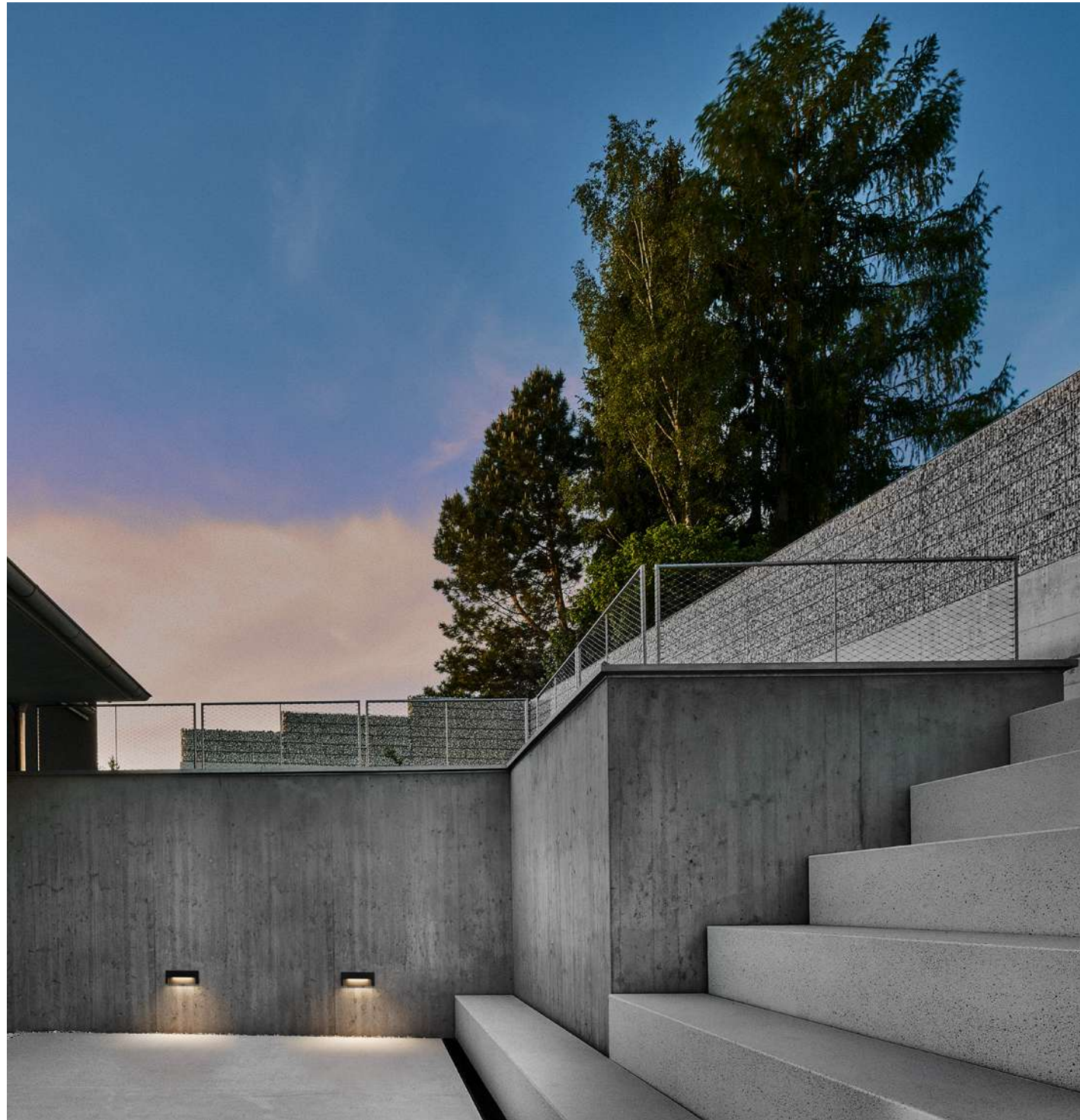

PRIVATE RESIDENCE AUSTRIA

# RETO

Outdoor  
Wall recessed

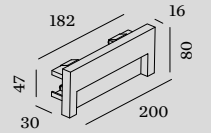

## 2.0

LED PCB 7W | const. volt. | 24V  
aluminium

IP65 SDCM3 L80|50K 0.41kg

47x182 40 min. 12

3000K | CRI >90 | 330lm

	CODE
	7453A2A5
	7453A2Q5
	7453A2B5

## ALWAYS USE

driver | IP67

	CODE
24V   35W	90212802
24V   100W	90212903

specs on page 810

## OPTIONAL

recessed housing incl. plasterkit

	CODE
	90012039

concrete housing

	CODE
	90012044

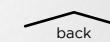



# ORIS

Outdoor  
Wall recessed

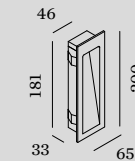

## 0.7

LED PCB 2/5W | 350/700mA | 6V  
aluminium

IP65 SDCM3 L70|60K 0.28kg

47x182 | 40 | min. 12

3000K | CRI >90 | 70/115lm

CODE	CODE
7091A1W5	7097A1W5
7091A1D5	7097A1D5
7091A1B5	7097A1B5

### ALWAYS USE

driver | IP66

CODE	CODE
3W   350mA	90213101
7W   500mA	90214301
7W   700mA	90215301

more options and specs on page 807

### OPTIONAL

recessed housing incl. plasterkit

CODE	CODE
90012039	90012043

concrete housing

CODE	CODE
90012044	90012042

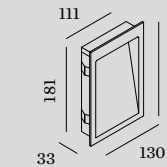

## 2.0

LED PCB 3/7W | 350/700mA | 9V  
aluminium

IP65 SDCM3 L70|60K 0.42kg

115x185 | 40 | min. 12

3000K | CRI >90 | 140/220lm

CODE	CODE
7097A1W5	7097A1D5
7097A1D5	7097A1B5

### ALWAYS USE

driver | IP66

CODE	CODE
3W   350mA	90213101
7W   500mA	90214301
7W   700mA	90215301

more options and specs on page 807

### OPTIONAL

recessed housing incl. plasterkit

CODE	CODE
90012043	90012042

concrete housing

CODE	CODE
90012042	

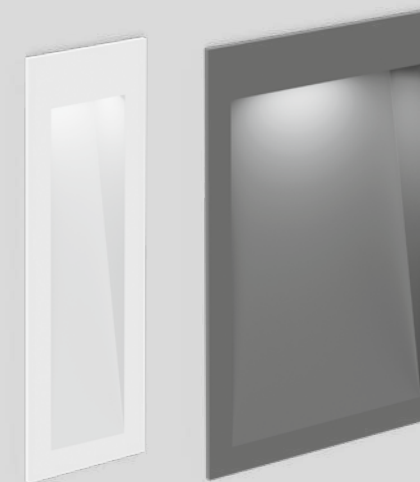



# ORIS

Outdoor  
Wall recessed

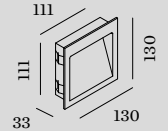
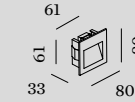

## 0.8

LED PCB 2/5W | 350/700mA | 6V  
aluminium

IP65 SDCM3 L70|60K 0.16kg

66x66 L40 min. 12

3000K | CRI >90 | 90/140lm

	CODE
	7094A1W5
	7094A1A5
	7094A1Q5
	7094A1B5

## ALWAYS USE

driver | IP66

	CODE
3W   350mA	90213101
7W   500mA	90214301
7W   700mA	90215301

more options and specs on page 807

## OPTIONAL

recessed housing incl. plasterkit

	CODE
	90012047

concrete housing

	CODE
	90012046

## 1.3

LED PCB 3/7W | 350/700mA | 9V  
aluminium

IP65 SDCM3 L70|60K 0.34kg

115x117 L40 min. 12

3000K | CRI >90 | 140/220lm

	CODE
	7096A1W5
	7096A1D5
	7096A1A5
	7096A1Q5
	7096A1B5

## ALWAYS USE

driver | IP66

	CODE
3W   350mA	90213101
7W   500mA	90214301
7W   700mA	90215301

more options and specs on page 807

## OPTIONAL

recessed housing incl. plasterkit

	CODE
	90012041

concrete housing

	CODE
	90012040



## SPOT LIGHTS



**TRAM**  
713



**TUBE 1.0**  
715



**TUBE 2.0**  
717



**TAIO**  
719



**RAY 1.0 | 2.0**  
721



**RAY 3.0 | 4.0**  
721



**TRAIN**  
723



**KIOSK**  
725



**CENTRAL**  
727



**TUBE CARRÉ 1.0**  
729



**TUBE CARRÉ 2.0**  
731



**BOX 1.0 | 2.0**  
733



**BOX 3.0 | 4.0**  
735



**X-BEAM**  
737



**X-BEAM ROUND**  
737

## LUMINAIRES



**RETO 1.3**  
739



**RETO 2.0**  
739



**PALOS 1.0**  
741



**PALOS 2.0**  
741



**PALOS 3.0**  
741



**BLAS 1.0**  
743



**BLAS 2.0**  
743



**TAPE**  
745



**SWAM**  
747



PRIVATE RESIDENCE AUSTRIA

# TRAM

Outdoor  
Wall surface

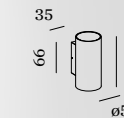
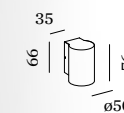
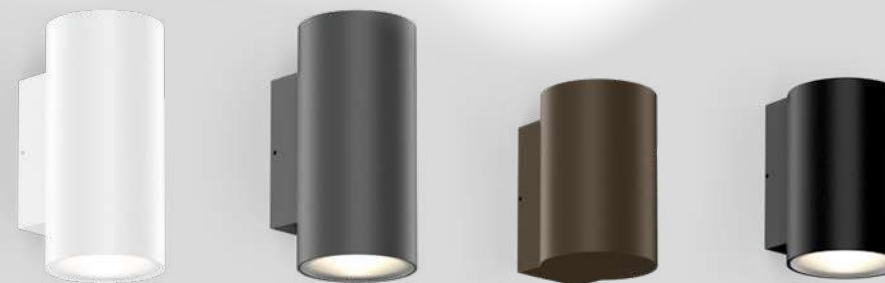

## 1.0

LED COB 6W | phase-cut dim  
220-240VAC | 50-60Hz  
aluminium

IP65 36° SDCM3 L70|55K 0.25kg

3000K | CRI >90 | 560lm

	CODE
	747568W5
	747568A5
	747568Q5
	747568B5

## 2.0

LED COB 9W | phase-cut dim  
220-240VAC | 50-60Hz  
aluminium

IP65 36° SDCM3 L70|55K 0.30kg

3000K | CRI >90 | 2x360lm

	CODE
	747668W5
	747668A5
	747668Q5
	747668B5



# TUBE

Outdoor  
Wall surface

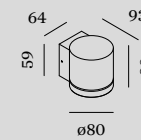
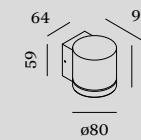
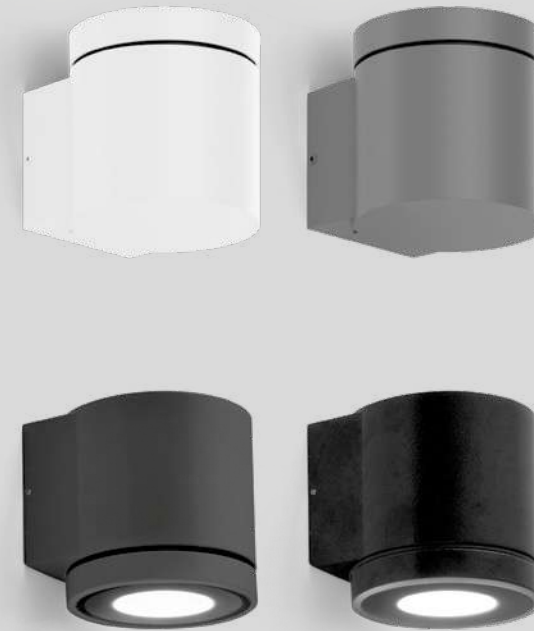

## 1.0 LED

LED COB 10W | phase-cut dim  
220-240VAC | 50-60Hz | incl. driver  
aluminium

IP65 | 36° SDCM3 L80|60K 0.53kg



3000K | CRI >90 | 630lm

	CODE
	711364W5
	711364D5
	711364A5
	711364B5

## 1.0 PAR16



PAR16 max. 5W | GU10  
100-240VAC | 50-60Hz  
aluminium

IP65 | 0.49kg

	CODE
	711120W0
	711120D0
	711120A0
	711120Q0
	711120B0

## OPTIONAL

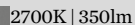
PAR16 4.3W | GU10

	CODE
	2700K   350lm 905227S2
	3000K   350lm 905227S4





# TUBE

Outdoor  
Wall surface

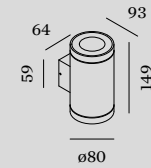
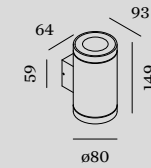
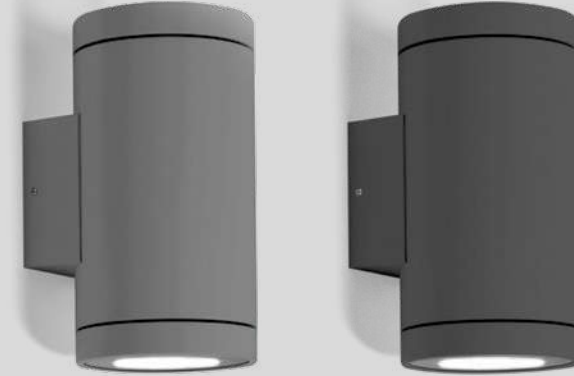

## 2.0 LED

LED COB 20W | phase-cut dim  
220-240VAC | 50-60Hz | incl. driver  
aluminium

IP65 ⚡ 36° SDCM3 L80|60K 0.88kg

3000K | CRI >90 | 2x630lm

## 2.0 PAR16

2x PAR16 max. 5W | GU10  
100-240VAC | 50-60Hz  
aluminium

IP65 ⚡ 0.67kg

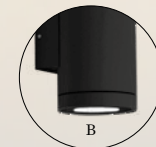
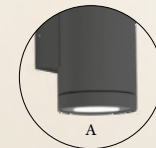
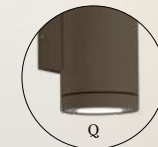
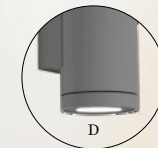

CODE

711464W5  
711464D5  
711464A5  
711464B5

CODE

711220W0  
711220D0  
711220A0  
711220Q0  
711220B0

## OPTIONAL

PAR16 4.3W | GU10

CODE

2700K | 350lm 905227S2  
3000K | 350lm 905227S4

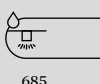
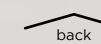









# TAIO

Outdoor  
Wall surface

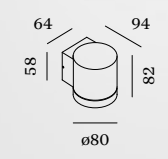
-  147
-  147
-  281



## 1.0

 LED COB 12W | phase-cut dim  
220-240VAC | 50-60Hz | incl. driver  
aluminium | protector glass  
opal glass convex lens

 IP65  105° SDCM2 L80|55K 0.49kg

CODE	
	180584W_
	180584A_
	180584Q_
	180584B_

LIGHT COLOUR	LUMEN CRI	CODE
2700K	430 >90	3
3000K	460 >90	5

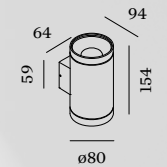



## 2.0

 LED COB 20W | phase-cut dim  
220-240VAC | 50-60Hz | incl. driver  
aluminium | protector glass  
opal glass convex lens

 IP65  105° SDCM2 L80|55K 0.85kg

CODE	
	180684W_
	180684A_
	180684Q_
	180684B_

LIGHT COLOUR	LUMEN CRI	CODE
2700K	2x430 >90	3
3000K	2x460 >90	5

-  677
-  687

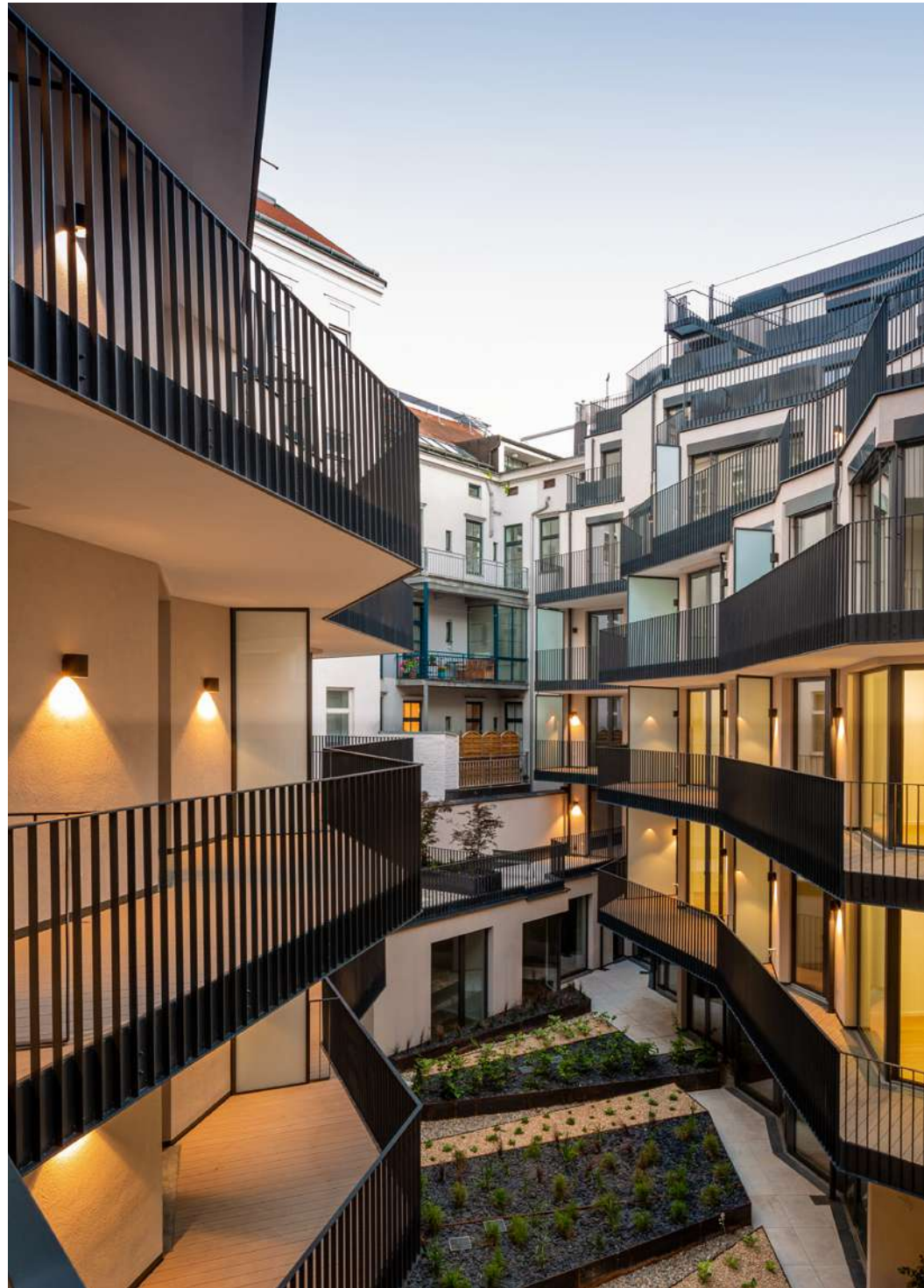

# RAY

Outdoor  
Wall surface

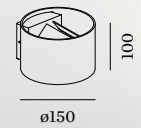

## 1.0

LED PCB 6W | phase-cut dim  
220-240VAC | 50-60Hz  
aluminium

IP65 SDCM3 L80|55K 0.47kg

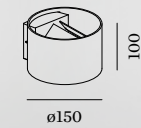

## 2.0

LED PCB 11W | phase-cut dim  
220-240VAC | 50-60Hz  
aluminium

IP65 SDCM3 L80|55K 0.47kg



## 3.0

LED PCB 6W | phase-cut dim  
220-240VAC | 50-60Hz  
aluminium

IP65 SDCM3 L80|55K 0.53kg

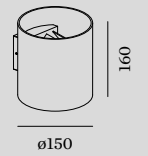

## 4.0

LED PCB 11W | phase-cut dim  
220-240VAC | 50-60Hz  
aluminium

IP65 SDCM3 L80|55K 0.53kg

	CODE
	749168W_
	749168B_

incl. adjustable flaps

LIGHT COLOUR	LUMEN CRI	CODE
2700K	350 >90	3
3000K	370 >90	5

	CODE
	749148W_
	749148B_

incl. adjustable flaps

LIGHT COLOUR	LUMEN CRI	CODE
2700K	2x440 >90	3
3000K	2x460 >90	5

	CODE
	749268W_
	749268B_

incl. adjustable flaps

LIGHT COLOUR	LUMEN CRI	CODE
2700K	260 >90	3
3000K	280 >90	5

	CODE
	749248W_
	749248B_

incl. adjustable flaps

LIGHT COLOUR	LUMEN CRI	CODE
2700K	2x325 >90	3
3000K	2x345 >90	5



# TRAIN

Outdoor  
Wall surface

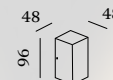
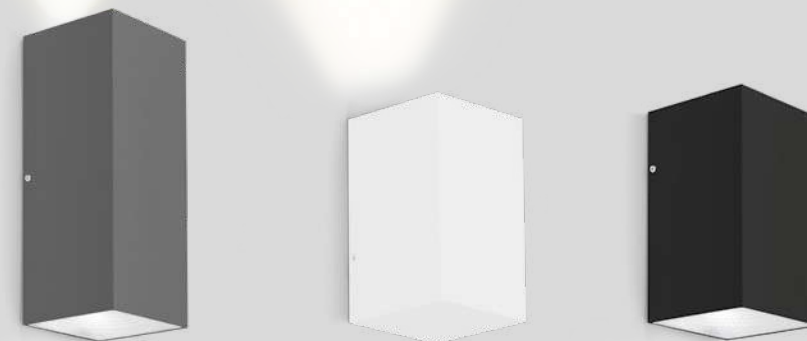

## 1.0 NARROW

LED PCB 6W  
220-240VAC | 50-60Hz | incl. driver  
aluminium  
narrow up or narrow down lens

IP65 | 55°x5° SDCM3 L80|60K 0.24kg

3000K | CRI >80 | 170lm

CODE  
718143B4

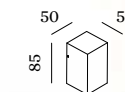

## 1.0

LED COB 6W | phase-cut dim  
220-240VAC | 50-60Hz  
aluminium

IP65 | 38° SDCM3 L70|55K 0.24kg

3000K | CRI >90 | 570lm

CODE  
718868W5  
718868A5  
718868B5

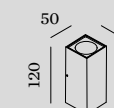

## 2.0

LED COB 8W | phase-cut dim  
220-240VAC | 50-60Hz  
aluminium

IP65 | 38° SDCM3 L70|55K 0.35kg

3000K | CRI >90 | 2x360lm

CODE  
718968W5  
718968A5  
718968B5



# KIOSK

Outdoor  
Wall surface

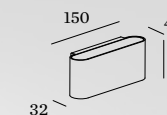

## 1.0

LED PCB 12W | phase-cut dim  
220-240VAC | 50-60Hz | incl. driver  
aluminium

IP65 SDCM3 180|50K 0.50kg

	CODE
	707174W_
	707174A_
	707174Q_
	707174B_

LIGHT COLOUR	LUMEN CRI	CODE
2700K	2x450 >90	3
3000K	2x500 >90	5

back





# CENTRAL

Outdoor  
Wall surface

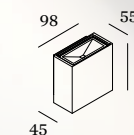
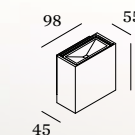



## 1.0

LED COB 8W | phase-cut dim  
220-240VAC | 50-60Hz | incl. driver  
aluminium

IP65 SDCM3 L80|60K 0.58kg

3000K | CRI >90 | 620lm

	CODE
	313774W5
	313774A5
	313774Q5
	313774B5

## 2.0

LED COB 8W | phase-cut dim  
220-240VAC | 50-60Hz | incl. driver  
aluminium

IP65 SDCM3 L80|60K 0.52kg

3000K | CRI >90 | 2x340lm

	CODE
	313874W5
	313874A5
	313874Q5
	313874B5



PRIVATE RESIDENCE | TRANSFORM ARCHITECTUUR BELGIUM

# TUBE CARRÉ

Outdoor  
Wall surface

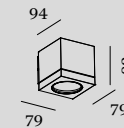
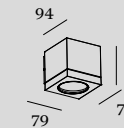
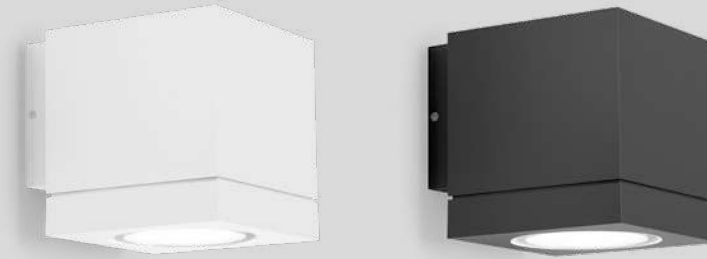

## 1.0 LED

LED LED COB 10W | phase-cut dim  
220-240VAC | 50-60Hz | incl. driver  
aluminium

IP65 36° SDCM3 L80I60K 0.71kg

3000K | CRI >90 | 720lm

	CODE
	744364W5
	744364D5
	744364A5
	744364B5

## 1.0 PAR16

PAR16 max. 5W | GU10  
100-240VAC | 50-60Hz  
aluminium

IP65 0.64kg

	CODE
	744120W0
	744120D0
	744120A0
	744120Q0
	744120B0

## OPTIONAL

PAR16 4.3W | GU10

	CODE
	2700K   350lm 905227S2
	3000K   350lm 905227S4

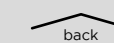



# TUBE CARRÉ

Outdoor  
Wall surface

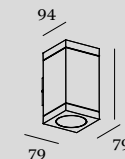
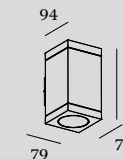

## 2.0 LED

LED COB 20W | phase-cut dim  
220-240VAC | 50-60Hz | incl. driver  
aluminium

IP65 | 36° SDCM3 L80/60K 1.13kg

3000K | CRI >90 | 2x720lm

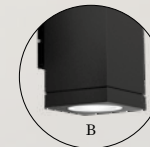
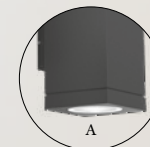
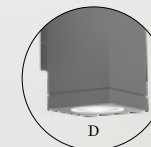

## 2.0 PAR16

2x PAR16 max. 5W | GU10  
100-240VAC | 50-60Hz  
aluminium

IP65 | 0.94kg

CODE	CODE
744464W5	744220W0
744464D5	744220D0
744464A5	744220A0
744464B5	744220Q0
	744220B0

## OPTIONAL

PAR16 4.3W | GU10

CODE	CODE
2700K   350lm	905227S2
3000K   350lm	905227S4



# BOX

Outdoor  
Wall surface

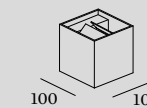
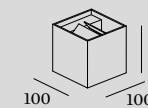
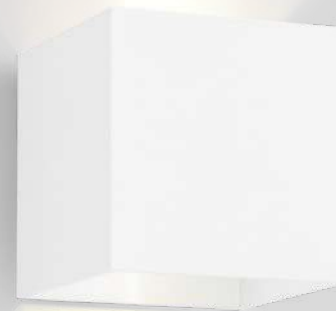

## 1.0

LED PCB 6W | phase-cut dim  
220-240VAC | 50-60Hz  
aluminium

IP65 SDCM3 L80|55K 0.60kg

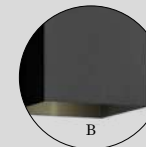
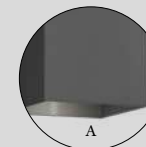
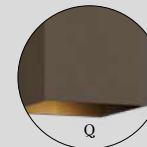
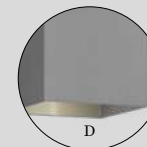

	CODE
	748168W_
	748168D_
	748168A_
	748168Q_
	748168B_

incl. adjustable flaps

LIGHT COLOUR	LUMEN CRI	CODE
2700K	350 >90	3
3000K	370 >90	5

## 2.0

LED PCB 11W | phase-cut dim  
220-240VAC | 50-60Hz  
aluminium

IP65 SDCM3 L80|55K 0.62kg

	CODE
	748148W_
	748148D_
	748148A_
	748148Q_
	748148B_

incl. adjustable flaps

LIGHT COLOUR	LUMEN CRI	CODE
2700K	2x440 >90	3
3000K	2x460 >90	5



169



311



535



695







# BOX

Outdoor  
Wall surface

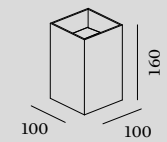
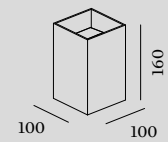
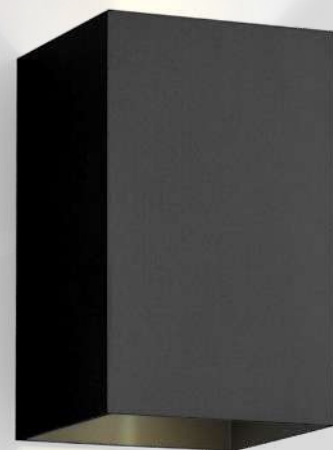

## 3.0

LED PCB 6W | phase-cut dim  
220-240VAC | 50-60Hz  
aluminium

IP65 SDCM3 L80I55K 0.67kg

## 4.0

LED PCB 11W | phase-cut dim  
220-240VAC | 50-60Hz  
aluminium

IP65 SDCM3 L80I55K 0.86kg

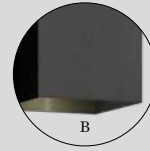
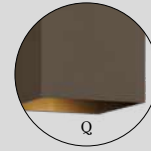
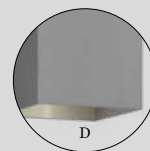

CODE		
	748268W_	
	748268D_	
	748268Q_	
	748268B_	

incl. adjustable flaps

LIGHT COLOUR	LUMEN CRI	CODE
2700K	260 >90	3
3000K	280 >90	5

CODE		
	748248W_	
	748248D_	
	748248Q_	
	748248B_	

incl. adjustable flaps

LIGHT COLOUR	LUMEN CRI	CODE
2700K	2x325 >90	3
3000K	2x345 >90	5



SHOWROOM CHILLOUT AREA GRAZ | AUSTRIA

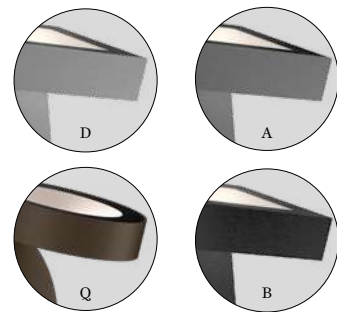

# X-BEAM

Outdoor  
Wall surface

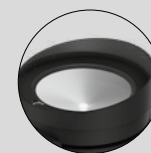
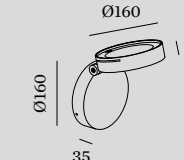
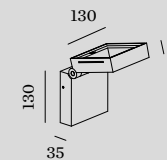

## OPTIONAL

snoot

CODE

90019023

snoot round

CODE

90019031

specs on page 816

## 1.0

LED PCB 25W | phase-cut dim  
220-240VAC | 50-60Hz | incl. driver  
aluminium

IP65 0-110° 108° SDCM3 L80160K 1.22kg

3000K | CRI >80 | 1680lm

CODE 700374D4

700374A4

700374B4

## 1.0 ROUND

LED PCB 25W | phase-cut dim  
220-240VAC | 50-60Hz | incl. driver  
aluminium

IP65 0-110° 108° SDCM3 L80160K 1.41kg

3000K | CRI >80 | 1680lm

CODE 700474A4

700474Q4

700474B4



# RETO

Outdoor  
Wall surface

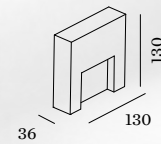
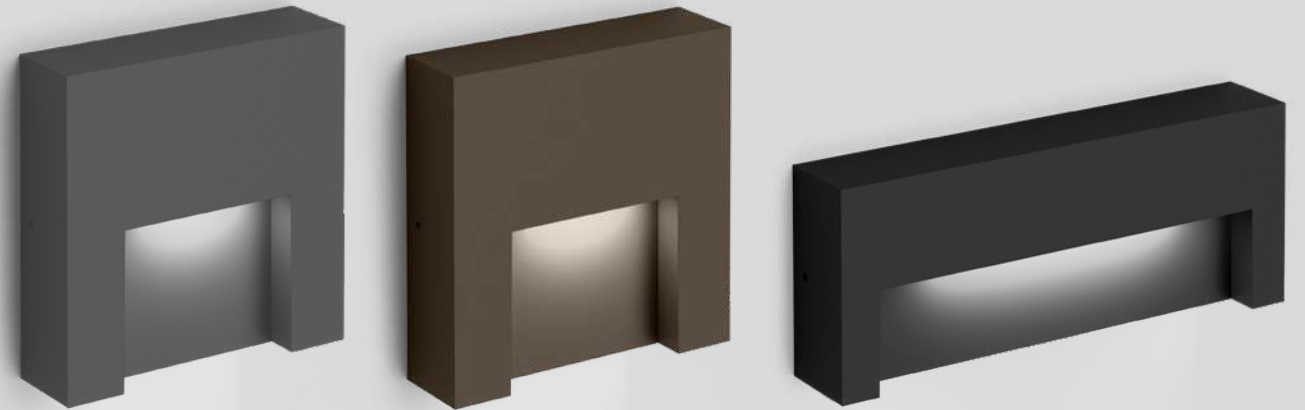

## 1.3

LED PCB 5W | phase-cut dim  
220-240VAC | 50-60Hz | incl. driver  
aluminium

IP65 SDCM3 L80|50K 0.62kg

3000K | CRI >90 | 140lm

	CODE
	7455A4A5
	7455A4Q5
	7455A4B5

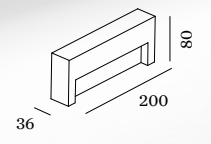

## 2.0

LED PCB 9W | phase-cut dim  
220-240VAC | 50-60Hz | incl. driver  
aluminium

IP65 SDCM3 L80|50K 0.58kg

3000K | CRI >90 | 340lm

	CODE
	7456A4A5
	7456A4Q5
	7456A4B5



# PALOS

Outdoor  
Wall surface

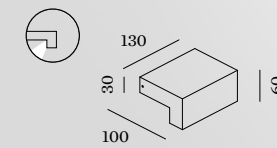
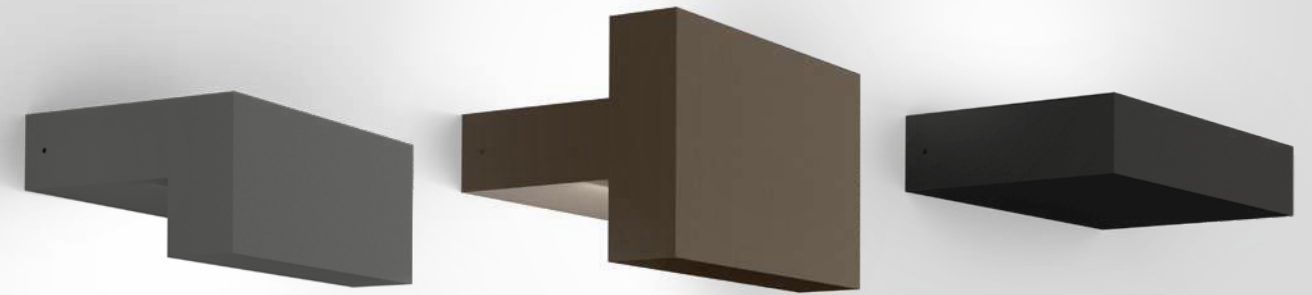

## 1.0

LED PCB 11W | phase-cut dim  
220-240VAC | 50-60Hz | incl. driver  
aluminium

IP65 SDCM3 L80|60K 0.86kg

CODE	
	4161A4A_
	4161A4Q_
	4161A4B_

LIGHT COLOUR	LUMEN CRI	CODE
2700K	605 >80	2
3000K	650 >80	4

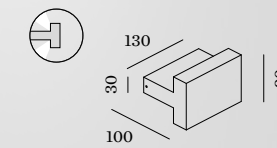

## 2.0

LED PCB 21W | phase-cut dim  
220-240VAC | 50-60Hz | incl. driver  
aluminium

IP65 SDCM3 L80|60K 1.15kg

CODE	
	4162A4A_
	4162A4Q_
	4162A4B_

LIGHT COLOUR	LUMEN CRI	CODE
2700K	710 >80	2
3000K	2x650 >80	4

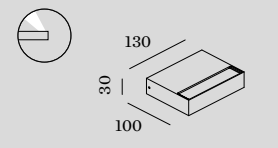

## 3.0

LED PCB 11W | phase-cut dim  
220-240VAC | 50-60Hz | incl. driver  
aluminium

IP65 SDCM3 L80|60K 0.75kg

CODE	
	4163A4A_
	4163A4Q_
	4163A4B_

LIGHT COLOUR	LUMEN CRI	CODE
2700K	710 >80	2
3000K	770 >80	4

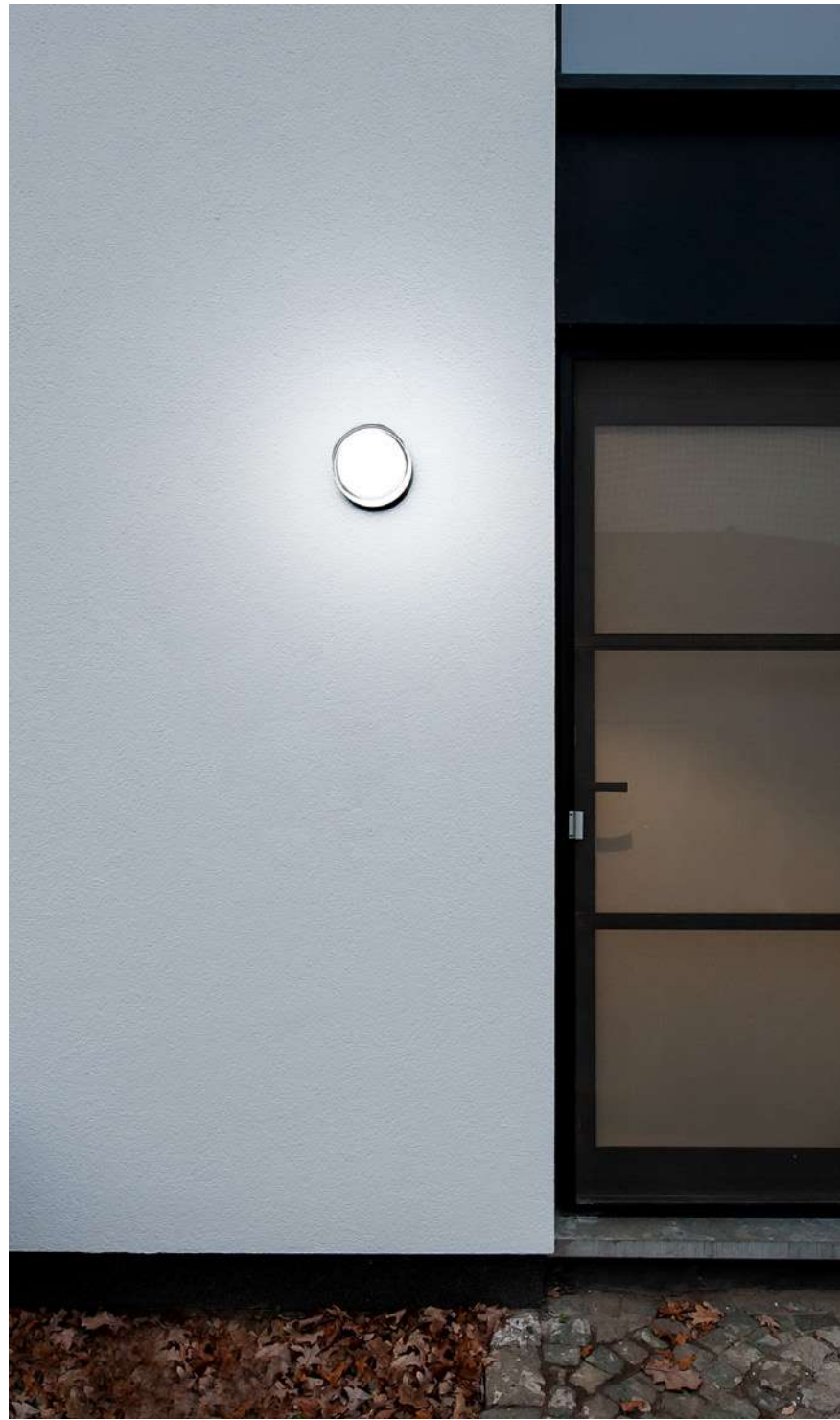

PRIVATE RESIDENCE BELGIUM

# BLAS

Outdoor  
Wall surface

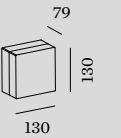

## 1.0

LED PCB 10W | phase-cut dim  
220-240VAC | 50-60Hz  
aluminium  
clear and frosted glass

IP65 SDCM3 L80|50K 1.00kg

3000K | CRI >90 | 950lm

CODE

736387W5

736387B5

## 2.0

LED PCB 10W | phase-cut dim  
220-240VAC | 50-60Hz  
aluminium  
clear and frosted glass

IP65 SDCM3 L80|50K 1.30kg

3000K | CRI >90 | 950lm

CODE

736487W5

736487B5



back



PRIVATE RESIDENCE AUSTRIA

# TAPE

Outdoor  
Wall surface

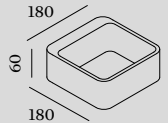

## 1.0

LED COB 8W | phase-cut dim  
220-240VAC | 50-60Hz | incl. driver  
aluminium

IP65 SDCMS L80|60K 0.73kg

3000K | CRI >90 | 420lm

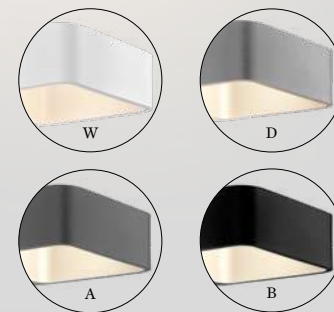

	CODE
	722174W5
	722174D5
	722174A5
	722174B5

back





PRIVATE RESIDENCE | ELLEMVIE - ART & INTERIEUR THE NETHERLANDS

# SWAM

Outdoor  
Wall surface

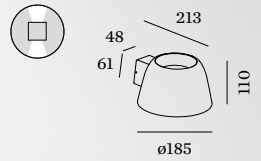
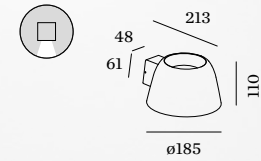

Q



K

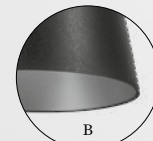

B

## 1.0

LED PCB 9W | phase-cut dim  
220-240VAC | 50-60Hz  
aluminium

IP65 SDCM3 L80|60K 0.91kg

2700K | CRI >90 | 410lm

CODE	
	746278Q3
	746278K3
	746278B3

## 2.0

LED PCB 13W | phase-cut dim  
220-240VAC | 50-60Hz  
aluminium

IP65 SDCM3 L80|60K 0.91kg

2700K | CRI >90 | 670lm

CODE	
	746378Q3
	746378K3
	746378B3

back

WEVER & DUCRÉ 746 - 747



777

## RECESSED



**CARD 0.1**  
751



**CARD 0.2**  
751



**BLINK**  
753



**MAP**  
755



**MAP ASYM**  
759



**CHART**  
761



**CHART ASYM**  
763





# CARD

Outdoor  
Floor recessed

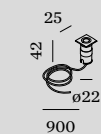
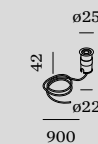

## O.1

LED PCB 1W | 350mA | 3V  
aluminium | stainless steel | glass

IP67 IK07  $\Delta$ 16° SDCM3 L70|60K 0.05kg

22-24 L60

3000K | CRI >80 | 90lm

CODE

75014114

## O.2

LED PCB 1W | 350mA | 3V  
aluminium | stainless steel | glass

IP67 IK07  $\Delta$ 16° SDCM3 L70|60K 0.06kg

22-24 L60

3000K | CRI >80 | 90lm

CODE

75024114

## ALWAYS USE

driver | IP66

CODE

3W | 350mA 90213101

more options and specs on page 807

## ALWAYS USE

driver | IP66

CODE

3W | 350mA 90213101

more options and specs on page 807





PRIVATE RESIDENCE GREECE

# BLINK

Outdoor  
trimless | Floor recessed

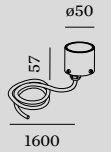
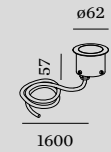

## 1.0

LED COB 5W | 500mA | 9V  
aluminium | glass

IP65 IK08  $\Delta$  30° SDCM2 L80/S0K 0.34kg

47-49  $\text{TL}63$

3000K | CRI >90 | 440lm

CODE

721161B5

## 1.0 TRIMLESS

LED COB 5W | 500mA | 9V  
aluminium | glass

IP65 IK08  $\Delta$  30° SDCM2 L80/S0K 0.32kg

3000K | CRI >90 | 440lm

CODE

721261B5

## OPTIONAL

recessed ground housing | plastic

137  $\text{TL}110$

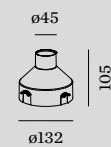

132

## ALWAYS USE

recessed ground housing | plastic

137  $\text{TL}110$

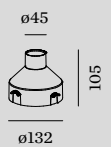

132

## ALWAYS USE

driver | 500mA

CODE

7W dim 90224301

7W IP67 90214301

more options and specs on page 808

CODE

90012201

CODE

90012201

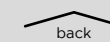
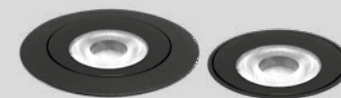

back



# MAP

Outdoor  
Floor recessed

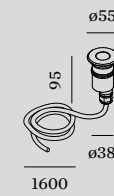

## 0.6

LED COB 5W | phase-cut dim  
220-240VAC | 50-60Hz  
aluminium | stainless steel | glass

IP67 IK08  $\Delta$  43° SDCM3 L70|55K 0.38kg

$\Sigma$  100

3000K | CRI >90 | 310lm

CODE  
75116815

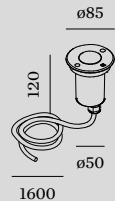

## 0.9

LED COB 8W | phase-cut dim  
220-240VAC | 50-60Hz  
aluminium | stainless steel | glass

IP67 IK08  $\Delta$  35° SDCM3 L70|55K 0.70kg

$\Sigma$  135

3000K | CRI >90 | 660lm

CODE  
75126815

## OPTIONAL

recessed ground housing | plastic

$\Sigma$  137  $\Sigma$  110

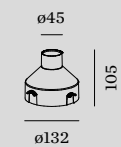

CODE  
90012201



## OPTIONAL

recessed ground housing | plastic

$\Sigma$  137  $\Sigma$  130

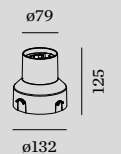

CODE  
90012202



# MAP

Outdoor  
Floor recessed

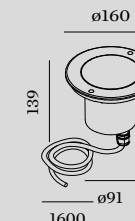
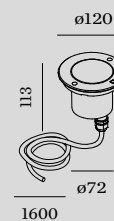

## 1.2

LED COB 12W | phase-cut dim  
220-240VAC | 50-60Hz  
aluminium | stainless steel | glass

IP67 IK08  $\Delta$  44° SDCM3 L70|55K 1.01kg

1120

3000K | CRI >90 | 1010lm

CODE

75136815

## 1.6

LED COB 16W | phase-cut dim  
220-240VAC | 50-60Hz  
aluminium | stainless steel | glass

IP67 IK09  $\Delta$  38° SDCM3 L70|55K 1.43kg

1185

3000K | CRI >90 | 1260lm

CODE

75146815

## OPTIONAL

recessed ground housing | plastic

190 1158

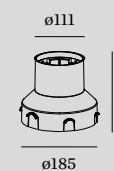

185

CODE

90012203

## OPTIONAL

recessed ground housing | plastic

220 1184

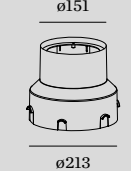

213

CODE

90012204



Rev. 001/2024-05

back



# MAP ASYM

Outdoor  
Floor recessed



## 1.2

LED COB 12W | phase-cut dim  
220-240VAC | 50-60Hz  
aluminium | stainless steel | glass  
asymmetric reflector

IP67 IK08 SDCM3 L70|55K 1.06kg

160

3000K | CRI >90 | 560lm

CODE

7515A8I5

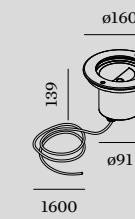

## 1.6

LED COB 15W | phase-cut dim  
220-240VAC | 50-60Hz  
aluminium | stainless steel | glass  
asymmetric reflector

IP67 IK09 SDCM3 L70|55K 1.72kg

185

3000K | CRI >90 | 850lm

CODE

7516A8I5

## OPTIONAL

recessed ground housing | plastic

190 158

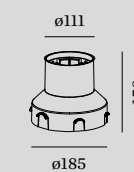

185

CODE

90012203

## OPTIONAL

recessed ground housing | plastic

220 184

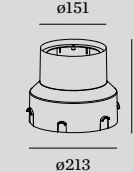

213

CODE

90012204





PRIVATE RESIDENCE FRANCE



# CHART

Outdoor  
Floor recessed

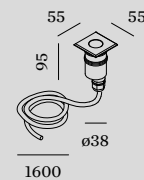

**0.6**

LED COB 5W | phase-cut dim  
220-240VAC | 50-60Hz  
aluminium | stainless steel | glass

IP67 IK08  $\Delta$  43° SDCM3 L70|55K 0.39kg

118

3000K | CRI >90 | 310lm

CODE

752168I5

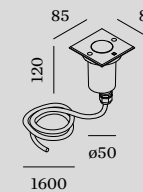

**0.9**

LED COB 8W | phase-cut dim  
220-240VAC | 50-60Hz  
aluminium | stainless steel | glass

IP67 IK08  $\Delta$  35° SDCM3 L70|55K 0.70kg

135

3000K | CRI >90 | 660lm

CODE

752268I5

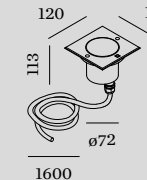

**1.2**

LED COB 12W | phase-cut dim  
220-240VAC | 50-60Hz  
aluminium | stainless steel | glass

IP67 IK08  $\Delta$  44° SDCM3 L70|55K 1.05kg

175

3000K | CRI >90 | 1010lm

CODE

752368I5

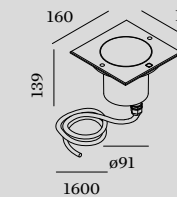

**1.6**

LED COB 16W | phase-cut dim  
220-240VAC | 50-60Hz  
aluminium | stainless steel | glass

IP67 IK09  $\Delta$  38° SDCM3 L70|55K 1.45kg

185

3000K | CRI >90 | 1260lm

CODE

752468I5

## OPTIONAL

recessed ground housing | plastic

137 110

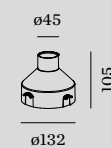

132

CODE

90012201

## OPTIONAL

recessed ground housing | plastic

137 130

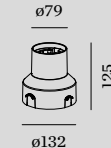

132

CODE

90012202

## OPTIONAL

recessed ground housing | plastic

190 158

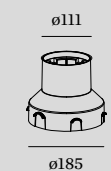

185

CODE

90012203

## OPTIONAL

recessed ground housing | plastic

220 184

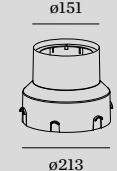

213

CODE

90012204

Rev. 001/2024-05

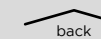



# CHART ASYM

Outdoor  
Floor recessed

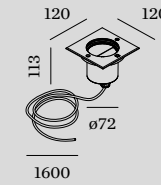

## 1.2

LED COB 12W | phase-cut dim  
220-240VAC | 50-60Hz  
aluminium | stainless steel | glass  
asymmetric reflector

IP67 IK08 SDCM3 L70|55K 1.10kg

160

3000K | CRI >90 | 560lm

CODE

7525A8I5

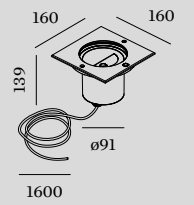

## 1.6

LED COB 15W | phase-cut dim  
220-240VAC | 50-60Hz  
aluminium | stainless steel | glass  
asymmetric reflector

IP67 IK09 SDCM3 L70|55K 1.83kg

185

3000K | CRI >90 | 850lm

CODE

7526A8I5

## OPTIONAL

recessed ground housing | plastic

190 158



185

CODE

90012203

## OPTIONAL

recessed ground housing | plastic

220 184

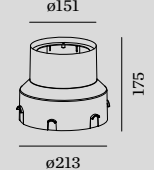

213

CODE

90012204



Rev. 001/2024-05

back

WEVER & DUCRÉ 762 – 763

## PLUG & PLAY

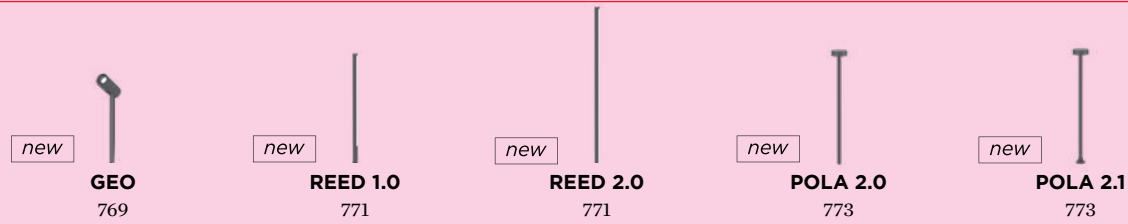

## LUMINAIRES



## PROJECTORS



## BOLLARDS



## PORTABLE LUMINAIRES





# One driver is all you need

They accentuate the façade, put the garden into the right light, and ensure that paths remain clearly visible even in the dark – modern outdoor lights are real all-rounders and are also particularly easy to install with a 24V-Plug & Play Connector System. All you need is a simple socket and a suitable driver that can be used to easily connect several lights. Simply select your favourite lights and start planning.

Sie akzentuieren die Fassade, rücken den Garten ins rechte Licht und sorgen dafür, dass Wege auch im Dunkeln gut sichtbar bleiben – moderne Outdoor-Leuchten sind echte Alleskönner und lassen sich mit einem 24V-Plug & Play Connector-System auch besonders einfach installieren. Was man dazu braucht? Eine simple Steckdose und einen passenden Treiber, über den sich auch mehrere Leuchten problemlos anschließen lassen. Also einfach Lieblingsleuchten auswählen und losplanen.



[weverducre.com/24v-plugplay](http://weverducre.com/24v-plugplay)

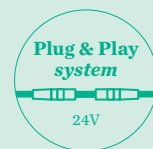

## 1 Choose your luminaires

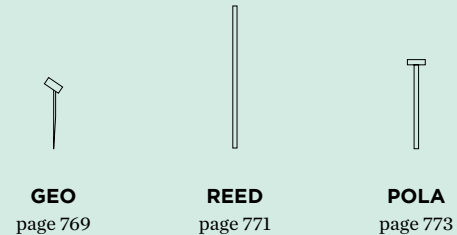

Two, three, four, or even more, the choice is yours! The number of lights and the sum of their individual wattages is the first thing you need to know to get started with your Plug & Play Connector System.

**Good to know:**  
24V Plug & Play Connector System recommends adding 2 or more luminaires to the driver.

## 2 Define the distance between driver and luminaire

Adjacent or far away. The distance between the driver and the first light is very important as it determines the further options of your 24V Plug & Play Connector System lighting solution. You can find detailed information about your options at [weverducre.com/24v-cable-length](http://weverducre.com/24v-cable-length)

**Good to know:**  
Each driver is supplied with two 2.5m cables, one for each side.

## 3 Choose your driver and set up your luminaires

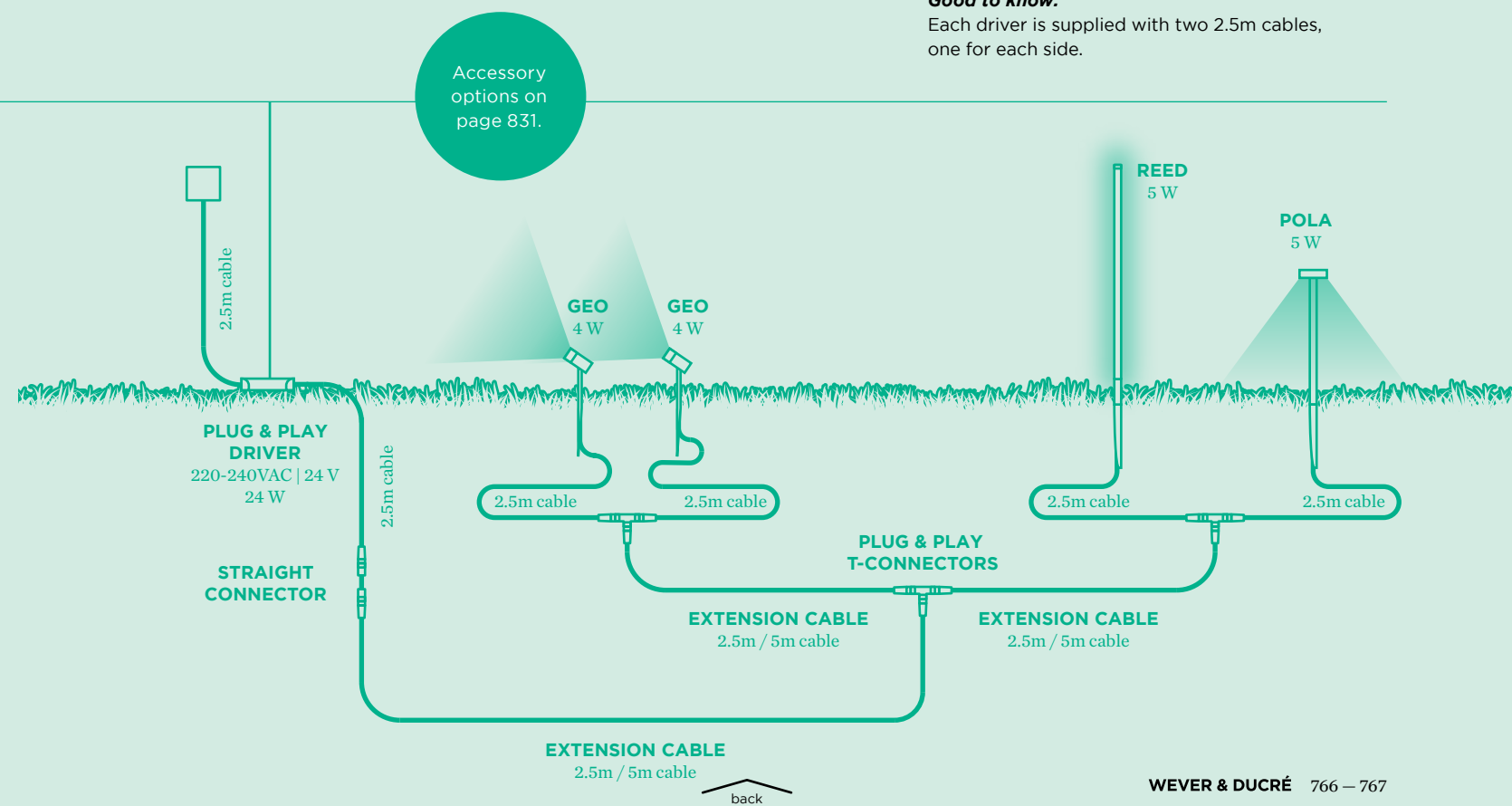

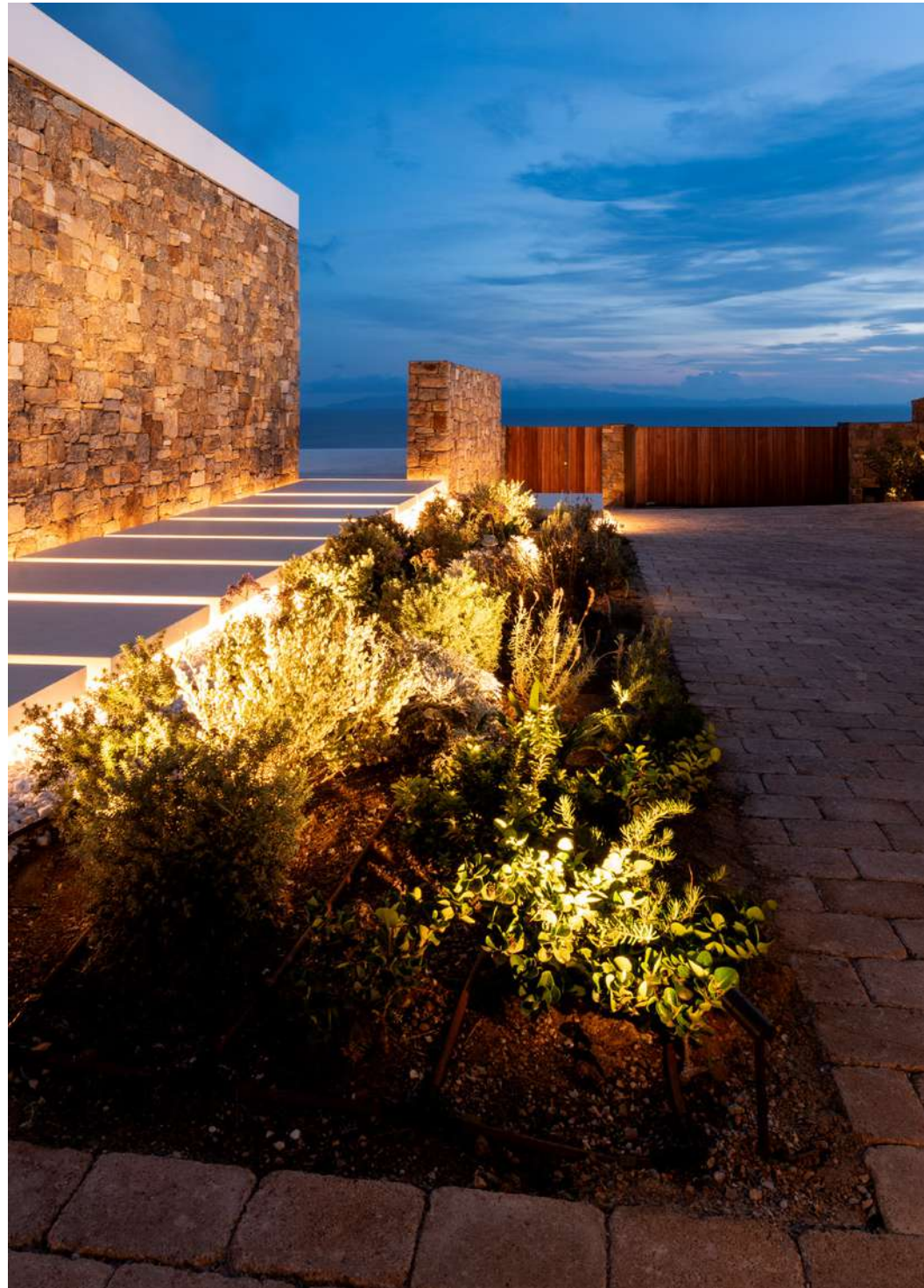

PRIVATE RESIDENCE GREECE

# GEO

Outdoor  
Floor surface

new

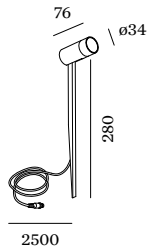

1.0

LED PCB 4W | 24V | ground spike  
aluminium | glass  
Plug & Play connector system  
incl. 2.5m cable | male plug

IP65 H07R-F 0°-135° 30° SDCM3 L80|50K 0.29kg

2700K | CRI >90 | 250lm

CODE	CODE
90014504	767562A3
	767562Q3

### ALWAYS USE

Plug & Play driver | 220-240VAC | 24V  
IP67 | incl. 2.5m cable with 240V plug  
incl. 2.5 cable with 24V male plug

CODE	CODE
2.5m 90014502	24W 90018014
5m 90014503	60W 90018015

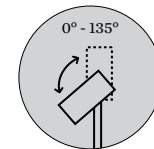
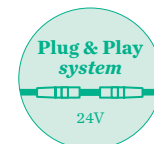

### OPTIONAL

Plug & Play straight connector IP67  
2x 24V female connector

CODE
90014504

Plug & Play t-connector IP67  
3x 24V female connector

CODE
90014501

Plug & Play extension cable IP67  
2x 24V male plug

CODE
2.5m 90014502
5m 90014503

back



# REED

Outdoor  
Floor surface

new

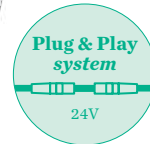
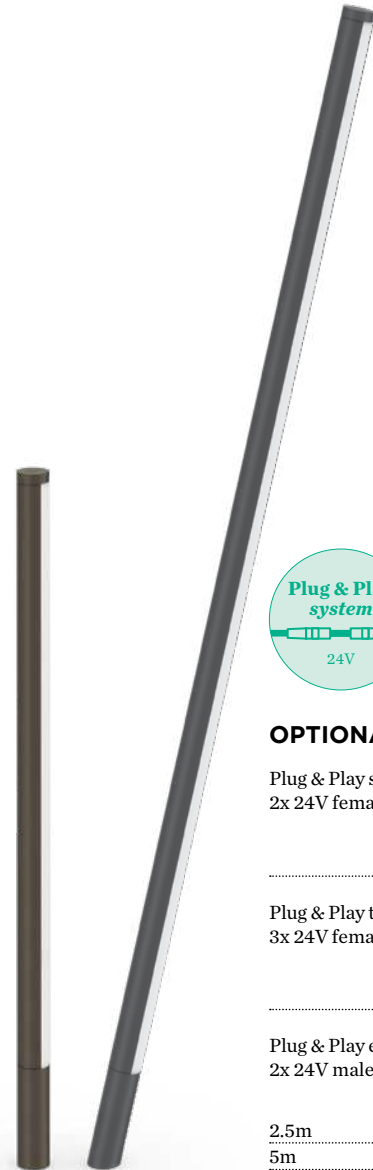

## OPTIONAL

Plug & Play straight connector IP67  
2x 24V female connector

CODE  
90014504

Plug & Play t-connector IP67  
3x 24V female connector

CODE  
90014501

Plug & Play extension cable IP67  
2x 24V male plug

	CODE
2.5m	90014502
5m	90014503

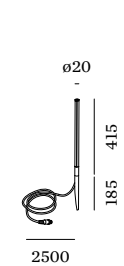

## 1.0

LED PCB 4W | 24V | ground spike  
aluminium | opal PC cover  
Plug & Play connector system  
incl. 2.5m cable | male plug

IP65 H07R-F SDCM3 L80|50K 0.20kg

2700K | CRI >90 | 350lm

	CODE
	770182A3
	770182Q3

## ALWAYS USE

Plug & Play driver | 220-240VAC | 24V  
IP67 | incl. 2.5m cable with 240V plug  
incl. 2.5 cable with 24V male plug

	CODE
24W	90018014
60W	90018015

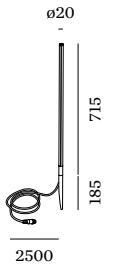

## 2.0

LED PCB 5W | 24V | ground spike  
aluminium | opal PC cover  
Plug & Play connector system  
incl. 2.5m cable | male plug

IP65 H07R-F SDCM3 L80|50K 0.30kg

2700K | CRI >90 | 450lm

	CODE
	770282A3
	770282Q3

## ALWAYS USE

Plug & Play driver | 220-240VAC | 24V  
IP67 | incl. 2.5m cable with 240V plug  
incl. 2.5 cable with 24V male plug

	CODE
24W	90018014
60W	90018015



# POLA

Outdoor  
Floor surface

new

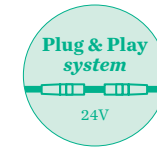
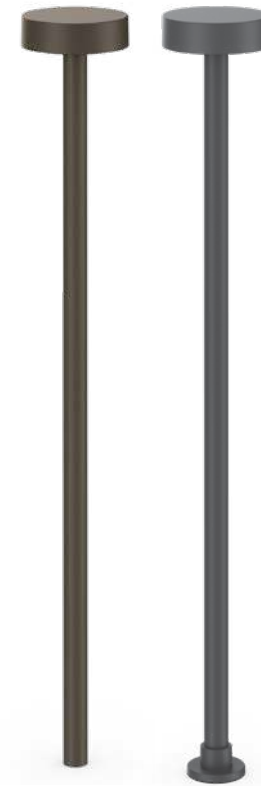

## OPTIONAL

Plug & Play straight connector IP67  
2x 24V female connector

CODE  
90014504

Plug & Play t-connector IP67  
3x 24V female connector

CODE  
90014501

Plug & Play extension cable IP67  
2x 24V male plug

CODE  
2.5m 90014502  
5m 90014503

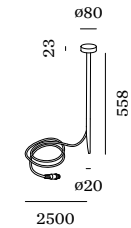

## 2.0

LED PCB 5W | 24V | ground spike  
aluminium | glass  
Plug & Play connector system  
incl. 2.5m cable | male plug

IP65 H07R-F SDCM3 L80|100K 0.55kg

2700K | CRI >90 | 265lm

CODE  
7381A2A3  
7381A2Q3

## ALWAYS USE

Plug & Play driver | 220-240VAC | 24V  
IP67 | incl. 2.5m cable with 240V plug  
incl. 2.5 cable with 24V male plug

CODE  
24W 90018014  
60W 90018015

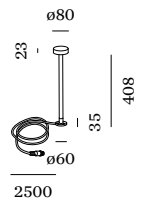

## 2.1

LED PCB 5W | 24V | fixation plate  
aluminium | glass  
Plug & Play connector system  
incl. 2.5m cable | male plug

IP65 H07R-F SDCM3 L80|100K 0.55kg

2700K | CRI >90 | 265lm

CODE  
7382A2A3  
7382A2Q3

## ALWAYS USE

Plug & Play driver | 220-240VAC | 24V  
IP67 | incl. 2.5m cable with 240V plug  
incl. 2.5 cable with 24V male plug

CODE  
24W 90018014  
60W 90018015

Rev. 001/2024-05

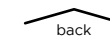



PRIVATE RESIDENCE SPAIN



# KIOSK

Outdoor  
Floor surface

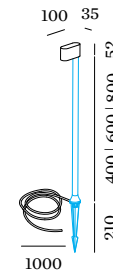

### 1.1

LED PCB 6W | phase-cut dim  
220-240VAC | 50-60Hz | incl. driver  
aluminium

IP65 SDCM3 L80I50K 0.41kg

3000K | CRI >90 | 370lm

	CODE
	7072A4A5
	7072A4Q5

### ALWAYS USE

pole | incl. ground spike

	CODE
400	910101_0
600	910102_0
800	910103_0

	CODE
	A
	Q

order fixation separately

### OPTIONAL

ground fixation plate

	CODE
	90019019

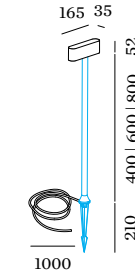

### 1.2

LED PCB 12W | phase-cut dim  
220-240VAC | 50-60Hz | incl. driver  
aluminium

IP65 SDCM3 L80I50K 0.53kg

3000K | CRI >90 | 2x370lm

	CODE
	7073A4A5
	7073A4Q5

### ALWAYS USE

pole | incl. ground spike

	CODE
400	910101_0
600	910102_0
800	910103_0

	CODE
	A
	Q

order fixation separately

### OPTIONAL

ground fixation plate

	CODE
	90019019

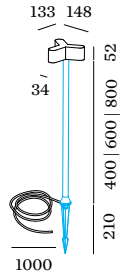

### 1.3

LED PCB 18W | phase-cut dim  
220-240VAC | 50-60Hz | incl. driver  
aluminium

IP65 SDCM3 L80I50K 0.65kg

3000K | CRI >90 | 3x370lm

	CODE
	7074A4A5
	7074A4Q5

### ALWAYS USE

pole | incl. ground spike

	CODE
400	910101_0
600	910102_0
800	910103_0

	CODE
	A
	Q

order fixation separately

### OPTIONAL

ground fixation plate

	CODE
	90019019





PRIVATE RESIDENCE AUSTRIA

# SWAM

Outdoor  
Floor surface

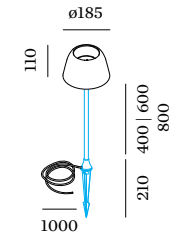

## 1.0

LED PCB 9W | phase-cut dim  
220-240VAC | 50-60Hz  
aluminium

IP65 SDCM3 L80I60K 0.97kg

2700K | CRI >90 | 310lm

	CODE
	746178Q3
	746178K3
	746178B3

### ALWAYS USE

straight pole | incl. ground spike

	CODE
400	910090_0
600	910091_0
800	910092_0

	CODE
	B
	Q

order fixation separately

### OPTIONAL

ground fixation plate

	CODE
	90019019

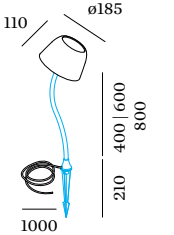

## 1.0

LED PCB 9W | phase-cut dim  
220-240VAC | 50-60Hz  
aluminium

IP65 SDCM3 L80I60K 0.97kg

2700K | CRI >90 | 310lm

	CODE
	746178Q3
	746178K3
	746178B3

### ALWAYS USE

curved pole | incl. ground spike

	CODE
400	910093_0
600	910094_0
800	910095_0

	CODE
	B
	Q

order fixation separately

### OPTIONAL

ground fixation plate

	CODE
	90019019



back



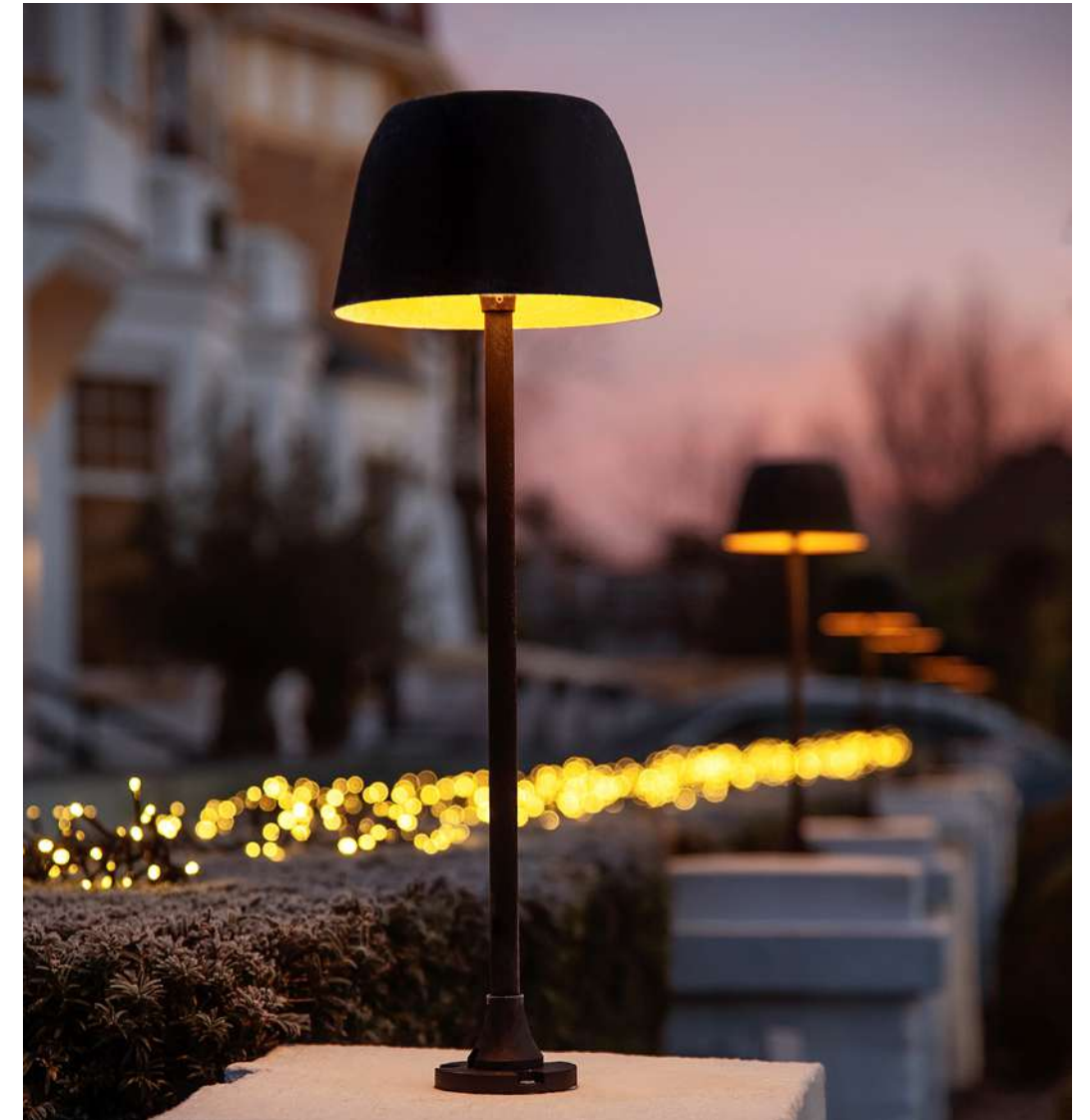



# TAPE

Outdoor  
Floor surface

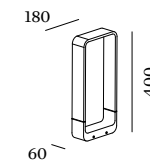

## 4.0

LED COB 8W | phase-cut dim  
220-240VAC | 50-60Hz | incl. driver  
aluminium

IP65 SDCM3 L80/60K 1.82kg

3000K | CRI >90 | 420lm

CODE  
722274D5

## OPTIONAL

ground spike

CODE  
90013102

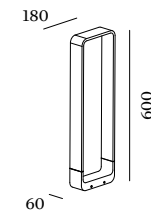

## 6.0

LED COB 8W | phase-cut dim  
220-240VAC | 50-60Hz | incl. driver  
aluminium

IP65 SDCM3 L80/60K 2.42kg

3000K | CRI >90 | 420lm

CODE  
722374D5

## OPTIONAL

ground spike

CODE  
90013102

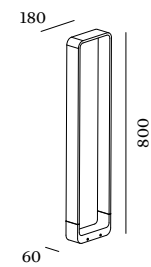

## 8.0

LED COB 8W | phase-cut dim  
220-240VAC | 50-60Hz | incl. driver  
aluminium

IP65 SDCM3 L80/60K 3.12kg

3000K | CRI >90 | 420lm

CODE  
722474D5

## OPTIONAL

ground spike

CODE  
90013102

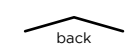



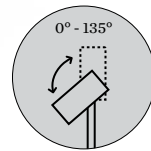

# STIPO

Outdoor  
Floor surface

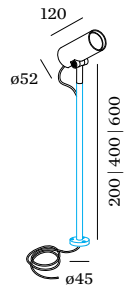
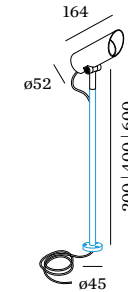
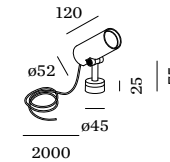
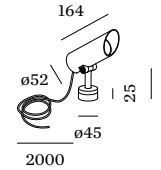

## 1.0

LED COB 7W | phase-cut dim  
220-240VAC | 50/60Hz  
aluminium

IP65 135° 38° SDCM3 L70|55K 0.59kg

3000K | CRI >90 | 450lm

	CODE
	737168A5
	737168Q5

## 2.0

LED COB 7W | phase-cut dim  
220-240VAC | 50/60Hz  
aluminium

IP65 135° 38° SDCM3 L70|55K 0.56kg

3000K | CRI >90 | 500lm

	CODE
	737268A5
	737268Q5

## 3.0

LED COB 7W | phase-cut dim  
220-240VAC | 50/60Hz  
aluminium

IP65 135° 38° SDCM3 L70|55K 0.53kg

3000K | CRI >90 | 450lm

	CODE
	737368A5
	737368Q5

## 4.0

LED COB 7W | phase-cut dim  
220-240VAC | 50/60Hz  
aluminium

IP65 135° 38° SDCM3 L70|55K 0.52kg

3000K | CRI >90 | 500lm

	CODE
	737468A5
	737468Q5

### ALWAYS USE

pole

	CODE
200	910062_0
400	910064_0
600	910066_0

	CODE
	A
	Q

order spike separately

### ALWAYS USE

pole

	CODE
200	910062_0
400	910064_0
600	910066_0

	CODE
	A
	Q

order spike separately

### OPTIONAL

ground spike

	CODE
	90013106

### OPTIONAL

ground spike

	CODE
	90013106

### OPTIONAL

ground spike

	CODE
	90013106

### OPTIONAL

ground spike

	CODE
	90013106



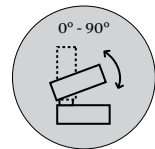

# STAKE | STAKE FOLD

Outdoor  
Floor surface

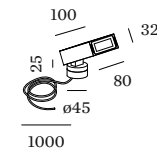

## 1.0 STAKE

LED COB 8W | phase-cut dim  
220-240VAC | 50-60Hz | incl. driver  
aluminium

IP65 0°-90° SDCM3 L80|60K 0.53kg

3000K | CRI >90 | 590lm

	CODE
	727174A5
	727174B5

## OPTIONAL

ground spike

	CODE
	90013106

snoot

	CODE
	90019004

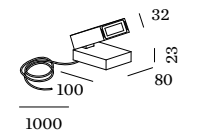

## 1.0 STAKE FOLD

LED COB 8W | phase-cut dim  
220-240VAC | 50-60Hz | incl. driver  
aluminium

IP65 0°-90° SDCM3 L80|60K 0.79kg

3000K | CRI >90 | 590lm

	CODE
	727274A5
	727274B5

## OPTIONAL

ground spike

	CODE
	90013107

snoot

	CODE
	90019004



back



PRIVATE RESIDENCE GREECE

# X-BEAM

Outdoor  
Floor surface

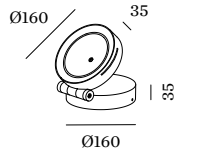
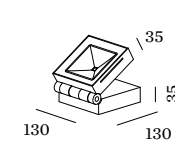
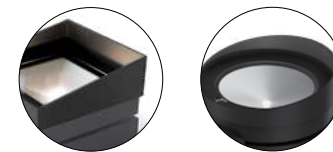

## OPTIONAL

ground spike

CODE  
90013115

snoot

CODE  
90019023

snoot round

CODE  
90019031

## 1.0

LED COB 25W | phase-cut dim  
220-240VAC | 50-60Hz | incl. driver  
aluminium

IP65 0-110°  $\Delta$ 108° SDCM3 L80|60K 1.22kg

3000K | CRI >80 | 1680lm

CODE	700374D4
	700374A4
	700374B4

## 1.0 ROUND

LED PCB 25W | phase-cut dim  
220-240VAC | 50-60Hz | incl. driver  
aluminium

IP65 0-110°  $\Delta$ 108° SDCM3 L80|60K 1.41kg

3000K | CRI >80 | 1680lm

CODE	700474A4
	700474Q4
	700474B4

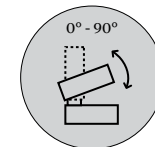

Rev. 001/2024-05

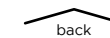

737





# GATE

Outdoor  
Floor surface

new

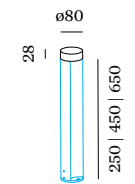
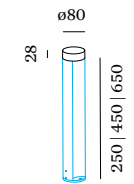

## 1.0

LED PCB 8W | phase-cut dim  
220-240VAC | 50-60Hz | incl. driver  
aluminium | glass

IP65 SDCM3 L80|50K 0.38kg

	CODE
	7581A4A_
	7581A4Q_

LIGHT COLOUR	LUMEN CRI	CODE
2700K	360 >80	2
3000K	380 >80	4

### ALWAYS USE

pole with fixation plate

	CODE
250	910121_0
450	910122_0
650	910123_0

	CODE
	A
	Q

## 2.0

LED PCB 11W | phase-cut dim  
220-240VAC | 50-60Hz | incl. driver  
aluminium | glass

IP65 SDCM3 L80|50K 0.38kg

	CODE
	7582A4A_
	7582A4Q_

LIGHT COLOUR	LUMEN CRI	CODE
2700K	2x280 >80	2
3000K	2x300 >80	4

### ALWAYS USE

pole with fixation plate

	CODE
250	910124_0
450	910125_0
650	910126_0

	CODE
	A
	Q



Rev. 001/2024-05

back



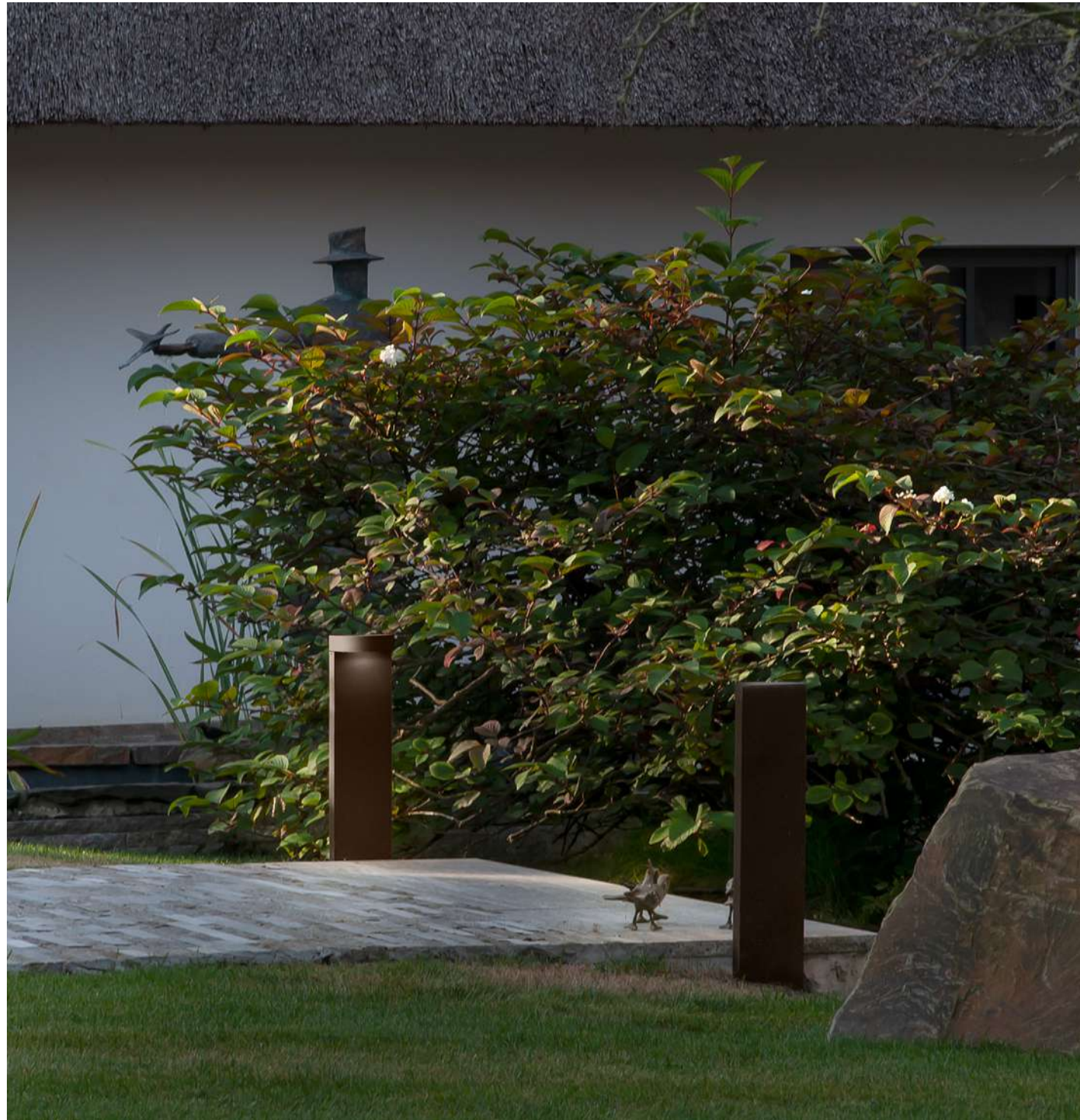

PRIVATE RESIDENCE BELGIUM

# PALOS ROUND

Outdoor  
Floor surface

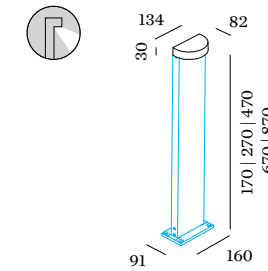

1.0

LED PCB 11W | phase-cut dim  
220-240VAC | 50-60Hz | incl. driver  
aluminium

IP65 SDCM3 L80|60K 0.70kg

	CODE
	4166A4A_
	4166A4Q_
	4166A4B_

LIGHT COLOUR	LUMEN CRI	CODE
2700K	605 >80	2
3000K	650 >80	4

### ALWAYS USE

pole with fixation plate

	CODE
170	910013_0
270	910014_0
470	910016_0
670	910018_0
870	910010_0

	CODE
	A
	Q
	B

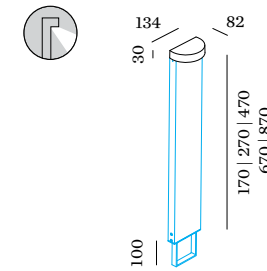

1.0

LED PCB 11W | phase-cut dim  
220-240VAC | 50-60Hz | incl. driver  
aluminium

IP65 SDCM3 L80|60K 0.70kg

	CODE
	4166A4A_
	4166A4Q_
	4166A4B_

LIGHT COLOUR	LUMEN CRI	CODE
2700K	605 >80	2
3000K	650 >80	4

### ALWAYS USE

pole with concrete fixation

	CODE
170	910073_0
270	910074_0
470	910076_0
670	910078_0
870	910070_0

	CODE
	A
	Q
	B



back



# PALOS ROUND

Outdoor  
Floor surface

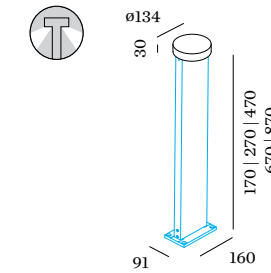

2.0

LED PCB 21W | phase-cut dim  
220-240VAC | 50-60Hz | incl. driver  
aluminium

IP65 SDCM3 L80|60K 1.16kg

CODE	
	4167A4A_
	4167A4Q_
	4167A4B_

LIGHT COLOUR	LUMEN CRI	CODE
2700K	2x605 >80	2
3000K	2x650 >80	4

## ALWAYS USE

pole with fixation plate

CODE	
170	910013_0
270	910014_0
470	910016_0
670	910018_0
870	910010_0

CODE	
	A
	Q
	B

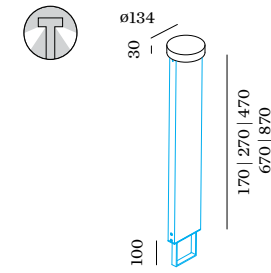

2.0

LED PCB 21W | phase-cut dim  
220-240VAC | 50-60Hz | incl. driver  
aluminium

IP65 SDCM3 L80|60K 1.16kg

CODE	
	4167A4A_
	4167A4Q_
	4167A4B_

LIGHT COLOUR	LUMEN CRI	CODE
2700K	2x605 >80	2
3000K	2x650 >80	4

## ALWAYS USE

pole with concrete fixation

CODE	
170	910073_0
270	910074_0
470	910076_0
670	910078_0
870	910070_0

CODE	
	A
	Q
	B



back

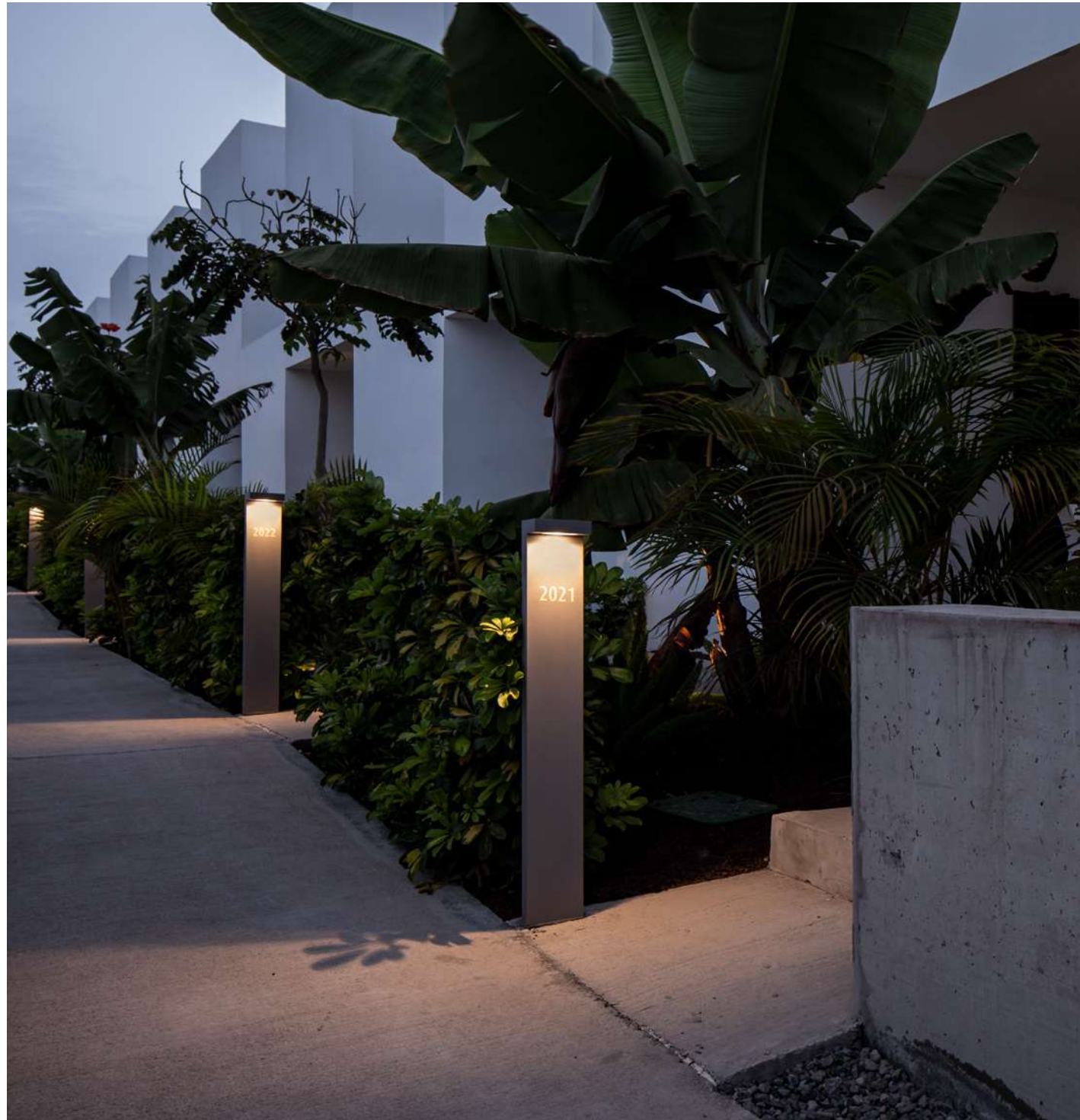

URBANIZACIÓN SANTA ÀGUEDA | ALONSO + SOSA ARCHITECTS | RAFAEL GAVIRA Y EMILIO PELLEJERO LAS PALMAS | SPAIN

# PALOS CARRÉ

Outdoor  
Floor surface

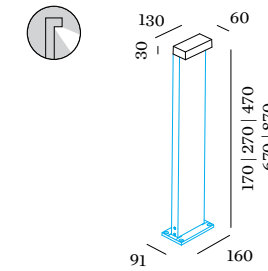

1.0

LED PCB 11W | phase-cut dim  
220-240VAC | 50-60Hz | incl. driver  
aluminium

IP65 SDCM3 L80|60K 0.65kg

CODE	
	4164A4A_
	4164A4Q_
	4164A4B_

LIGHT COLOUR	LUMEN CRI	CODE
2700K	605 >80	2
3000K	650 >80	4

## ALWAYS USE

pole with fixation plate

CODE	
170	910013_0
270	910014_0
470	910016_0
670	910018_0
870	910010_0

CODE	
	A
	Q
	B

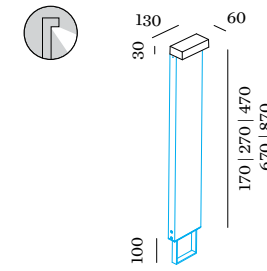

1.0

LED PCB 11W | phase-cut dim  
220-240VAC | 50-60Hz | incl. driver  
aluminium

IP65 SDCM3 L80|60K 0.65kg

CODE	
	4164A4A_
	4164A4Q_
	4164A4B_

LIGHT COLOUR	LUMEN CRI	CODE
2700K	605 >80	2
3000K	650 >80	4

## ALWAYS USE

pole with concrete fixation

CODE	
170	910073_0
270	910074_0
470	910076_0
670	910078_0
870	910070_0

CODE	
	A
	Q
	B



back





# PALOS CARRÉ

Outdoor  
Floor surface

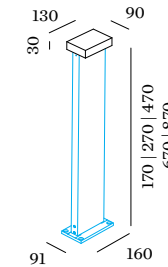

2.0

LED PCB 21W | phase-cut dim  
220-240VAC | 50-60Hz | incl. driver  
aluminium

IP65 SDCM3 L80|60K 0.97kg

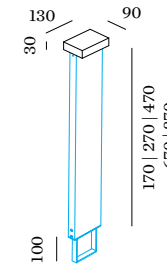

2.0

LED PCB 21W | phase-cut dim  
220-240VAC | 50-60Hz | incl. driver  
aluminium

IP65 SDCM3 L80|60K 0.97kg

CODE	
	4165A4A_
	4165A4Q_
	4165A4B_

LIGHT COLOUR	LUMEN CRI	CODE
2700K	2x605 >80	2
3000K	2x650 >80	4

## ALWAYS USE

pole with fixation plate

CODE	
170	910013_0
270	910014_0
470	910016_0
670	910018_0
870	910010_0

CODE	
	A
	Q
	B

CODE	
	4165A4A_
	4165A4Q_
	4165A4B_

LIGHT COLOUR	LUMEN CRI	CODE
2700K	2x605 >80	2
3000K	2x650 >80	4

## ALWAYS USE

pole with concrete fixation

CODE	
170	910073_0
270	910074_0
470	910076_0
670	910078_0
870	910070_0

CODE	
	A
	Q
	B



back





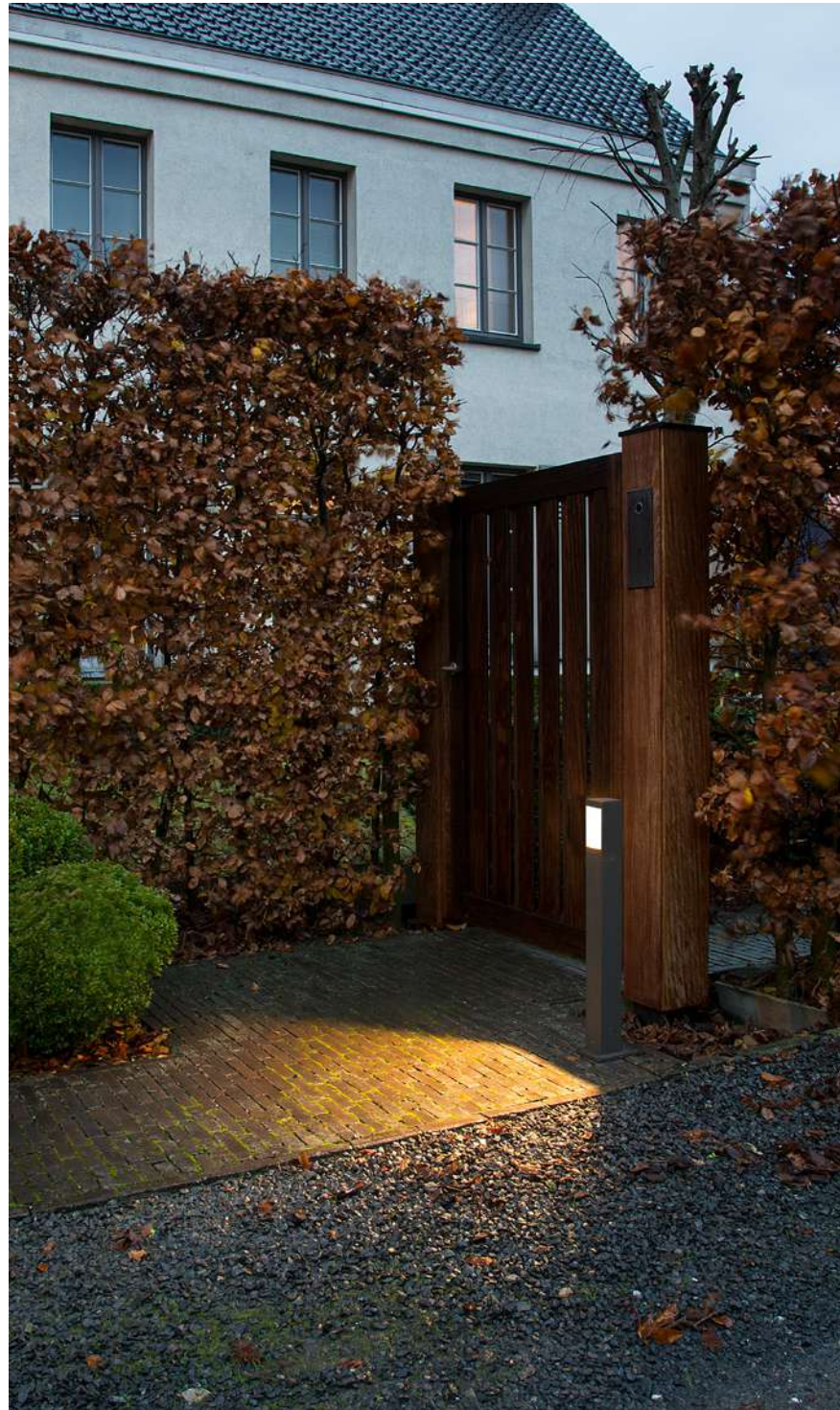

PRIVATE RESIDENCE BELGIUM

# LINUS

Outdoor  
Floor surface

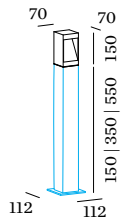



### 3.0

LED COB 7W | phase-cut dim  
220-240VAC | 50-60Hz  
aluminium

IP65 SDCM3 L70|50K 0.69kg



3000K | CRI >90 | 230lm

	CODE
	726378D5
	726378A5
	726378Q5

### ALWAYS USE

pole	CODE
150	910024_0
350	910026_0
550	910028_0

  

	CODE
	D
	A
	Q

### OPTIONAL

ground spike	CODE	90013103
ground fixation	CODE	90013302

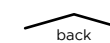
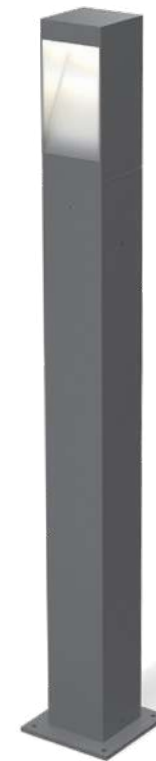

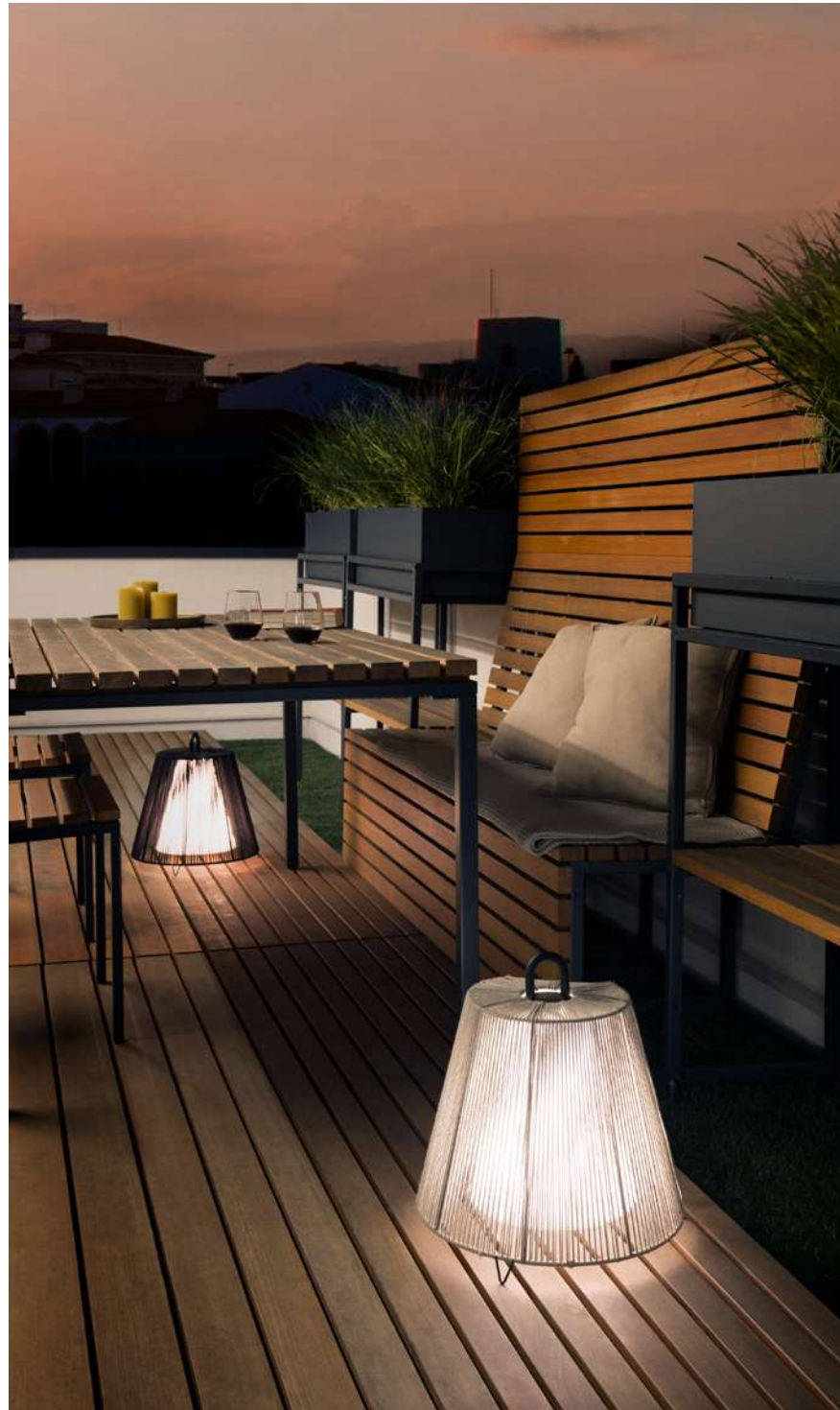

PRIVATE RESIDENCE | FIPE ARCHITECTS AUSTRIA

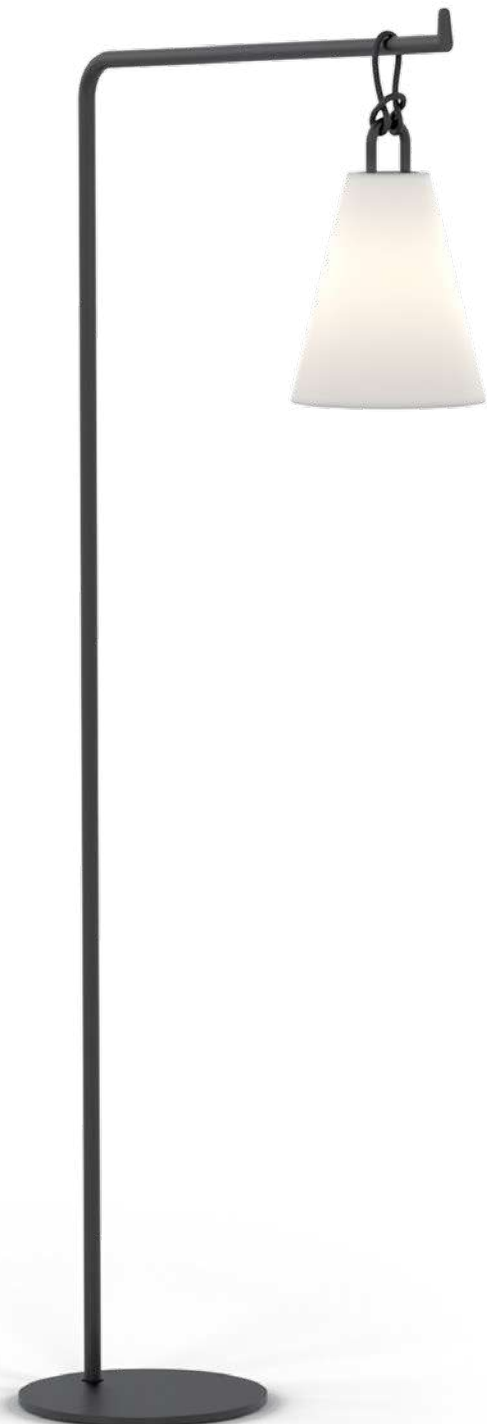

# COSTA

Outdoor  
Floor surface

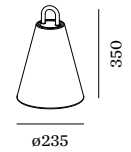

## 1.0

LED channels 3W | 130lm  
220-240VAC | 2200-4000K |  
colour change via push button  
rechargeable li-ion battery  
incl. charger | light for 8 hours  
recharging time 5 hours  
polyethylene | polypropylene

IP65 SDCM3 L80/60K 1.00kg

handle colour

	CODE
	865186YE9
	865186OR9
	865186SB9
	865186OB9

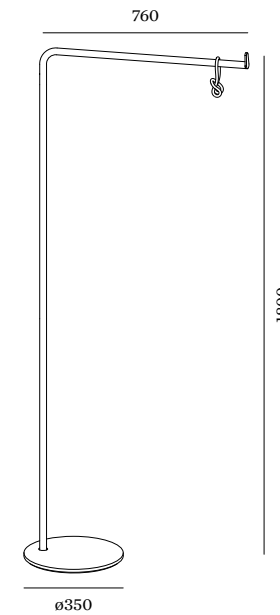

## OPTIONAL

inox pole powder coated

	CODE	90057171
	CODE	90056001

## OPTIONAL

1.0 rope

	CODE	90057171
	CODE	90057170

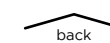
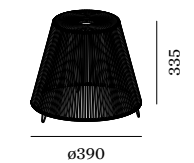



HOTEL YURBBAN BARCELONA | SPAIN

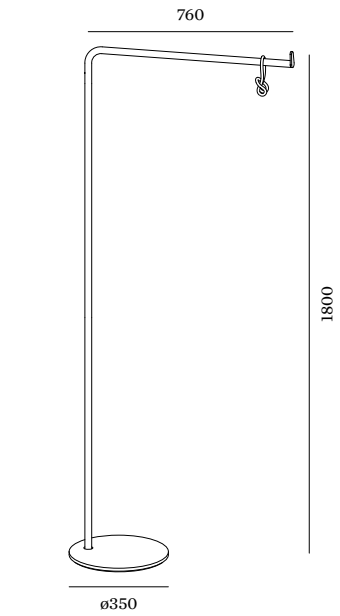
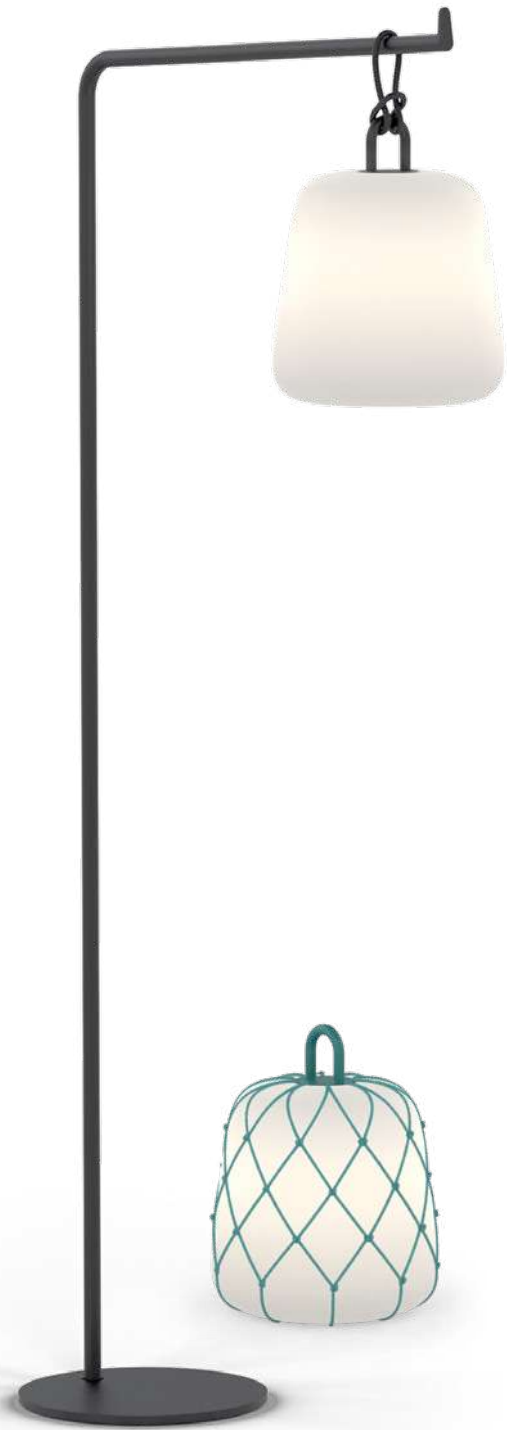

**OPTIONAL**  
inox pole powder coated

CODE	OPTIONAL
90056001	[Black swatch]

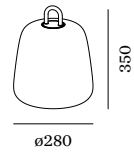

**OPTIONAL**

2.0 rope

CODE	OPTIONAL
90057192	[Yellow swatch]
90057191	[Red swatch]
90057193	[Teal swatch]
90057190	[Black swatch]

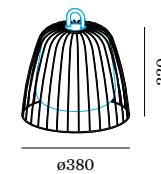

**OPTIONAL**

2.1 cage

CODE	OPTIONAL
90057182	[Yellow swatch]
90057181	[Red swatch]
90057183	[Teal swatch]
90057180	[Black swatch]

**2.0**

LED channels 3W | 130lm  
220-240VAC | 2200-4000K  
colour change via push button  
rechargeable li-ion battery  
incl. charger | light for 8 hours  
recharging time 5 hours  
polyethylene | polypropylene

IP65 SDCM3 L80/60K 1.10kg

handle colour

CODE	OPTIONAL
865286YE9	[Yellow swatch]
865286OR9	[Red swatch]
865286SB9	[Teal swatch]
865286OB9	[Black swatch]

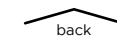

# *Accessories*

Sometimes just one small item is missing before everything is perfect. How convenient that we have several of them. From the suitable driver to the flexible track system. That way, it will always be exactly as you imagined it.

## DRIVER 250mA 5W DIM

5W | 250mA | 9-21V | phase-cut dim  
220-240VAC | 50-60Hz

L/W/H 69x34x22

IP20 0.04kg

**DEEP BIJOU** 1.0 | **MATCH POINT**

1.0 trimless, 1.0, 1.0 IP44 | **DEEP**

**POINT IP20** | **DEEP POINT IP44**

**RONY POINT**

## DRIVER 250mA 10.5W DIM

10.5W | preset at 250mA | 26-42V  
phase-cut dim | 220-240VAC

50-60Hz | 10-100%

L/W/H 122x41x23

IP20 0.10kg

**DEEP BIJOU** 2.0

## DRIVER 250mA 13W DALI

13W | preset at 250mA | 2.5-52V |  
DALI-2 | push dim | 220-240VAC

50-60Hz | 1-100%

L/W/H 144x33x21

IP20 0.08kg

**DEEP POINT** | **DEEP POINT IP44**

**DEEP BIJOU** 1.0, 2.0 | **MATCH**

**POINT** 1.0 trimless, 1.0, 1.0 IP44

**RONY POINT**

## DRIVER 350mA 6W

6W | 350mA | 3-22V  
90-264VAC | 50-60Hz

L/W/H 68x35x21

IP20 0.04kg

**LITO** | **ORIS** 0.7, 0.8, 1.3 | **STRIPE**

**RETO** indoor

## DRIVER 350mA 13W DIM

13W | 350mA | 26-38V | phase-cut dim  
220-240VAC | 50-60Hz | 10-100%

L/W/H 138x44x30

IP20 0.11kg

**LED MODULES HO** 905251W3

905251B3 | 902251W5 | 905251B5

905251B9 | 905251W9

**PLANO PETIT** 2.0 | **PIRRO PETIT**

6.0 | **STRANGE PETIT TRIMLESS**

2.0

## DRIVER 350mA 14.7W DIM

14.7W | 350mA | 26-42V | phase-cut dim  
220-240VAC | 50-60Hz

10-100%

L/W/H 122x41x23

IP20 0.08kg

**PIRRO PETIT** 6.0

## DRIVER 350mA 14W DALI

14W | preset at 350mA | 2.5-42V |  
DALI-2 | push dim | 220-240VAC

50-60Hz | 1-100%

L/W/H 145x33x21

IP20 0.08kg

**DEEP PETIT** | **DEEP ADJUST**

**PETIT** 1.0, 1.0 trimless | **PLANO**

**PETIT** 1.0, 2.0, 3.0 | **STRANGE**

**PETIT TRIMLESS** 1.0, 2.0, 3.0 |

**BLIEK PETIT** 1.0 | **BLIEK PETIT**

**TRIMLESS** 1.0 | **LECA** | **CENO** 1.0

semi-recessed, 1.0, 1.1 | **MATCH** 1.0

trimless, 1.0 | **MATCH STICK** | **BLIEK**

**ROUND PETIT** 1.0 trimless, 1.0 |

**LUNA ROUND/SQUARE**

## DRIVER 350mA 3W IP66

3W | 350mA | 3-12V  
90-264VAC | 50-60Hz

L/W/H 52x30x23

IP66 0.05kg

**ORIS** 0.7, 0.8, 1.3, 2.0 | **CARD**

CODE  
90226201

CODE  
90226501

CODE  
90246501

CODE  
90213202

CODE  
90223404

CODE  
90223504

CODE  
90243501

CODE  
90213101

## DRIVER 350mA 6W

6W | 350mA | 8.6-18V  
100-240VAC | 50-60Hz

L/W/H 67x39x22

IP20 0.04kg

**DEEP PETIT** | **DEEP ADJUST**

**PETIT** 1.0, 1.0 trimless | **PLANO**

**PETIT** 1.0, 3.0 | **STRANGE PETIT**

**TRIMLESS** 1.0, 3.0 | **MATCH** 1.0

trimless, 1.0 | **MATCH STICK** | **LECA**

**CENO** 1.0 semi-recessed, 1.0, 1.1

**BLIEK PETIT** 1.0 trimless, 1.0 | **LUNA**

**IP44** | **DEEP PETIT IP65**

## DRIVER 350mA 30W

30W | 350mA | 43-86V  
220-240VAC | 50-60Hz

L/W/H 127x43x30

IP20 0.10kg

## DRIVER 350mA 7W DIM

7W | 350mA | 12-21V | phase-cut dim  
220-240VAC | 50-60Hz

L/W/H 69x34x22

IP20 0.04kg

**MATCH** 1.0, trimless | **MATCH**

**STICK** | **LECA** | **CENO** 1.0 semi-

recessed, 1.0, 1.1 | **DEEP PETIT IP65**

## DRIVER 350mA 10W DIM

10W | 350mA | 13-26V | phase-cut dim  
220-240VAC | 50-60Hz

L/W/H 115x41x25

IP20 0.08kg

**DEEP PETIT** | **DEEP ADJUST**

**PETIT** 1.0, 1.0 trimless | **RONY**

**POINT** | **PLANO PETIT** 1.0, 3.0

**PIRRO PETIT** 4.0 | **STRANGE**

**PETIT TRIMLESS** 1.0, 3.0 | **BLIEK**

**PETIT** 1.0 trimless, 1.0 | **DEEP PETIT**

**IP65** | **LUNA ROUND IP44**

**LUNA SQUARE IP44**

## DRIVER 350mA 17W IP68

17W | 350mA | 5-49V  
220-240VAC | 50-60Hz

L/W/H 122x54x26

IP68 0.25kg

**DEEP IP65** | **DEEP PETIT IP65** |

**TAIO**

## DRIVER 350mA 4.5W DIM IP44

4.5W | 350mA | 8-13V | phase-cut dim  
220-240VAC | 50-60Hz | 5-100%

L/W/H 49x30x20

IP44 0.05kg

**PIRRO PETIT** 2.0

## DRIVER 350/500/700mA 17.5-20W

350/500/700mA output selection  
17.5W | 350mA | 25-50V

20W | 500mA | 20-40V

20W | 700mA | 14-28.5V

220-240VAC | 50-60Hz

L/W/H 102x51x30

IP20 0.09kg

**DEEP ADJUST** 2.0 | **PLANO**

**PETIT** 2.0 | **PLANO** 2.0 | **RON** 2.0

**STRANGE PETIT TRIMLESS** 2.0 |

**STRANGE TRIMLESS** 2.0 | **SNEAK**

2.0 | **SNEAK TRIMLESS** 2.0

## DRIVER 350/500/700mA 17-32W DIM

350/500/700mA | dipswitch selection

17W | 350mA | 2-47V

24W | 500mA | 2-47V

32W | 700mA | 2-46V

phase-cut dim | not for ambient dim

220-240VAC | 50-60Hz | push dim

L/W/H 166x46x34

IP20 0.19kg

CODE  
90213303

CODE  
90213701

CODE  
90223301

CODE  
90223406

CODE  
90213602

CODE  
90223101



CODE  
90218601

CODE  
90228801

# DRIVER | CONTROL GEAR

Accessories

## DRIVER 500mA 6W

6W | 500mA | 3-12V  
90-264VAC | 50-60Hz  
L/W/H 68x35x21  
☐ IP20 0.04kg CE  

**DEEP BIJOU IP65 | THEMIS STRANGE TRIMLESS** wall | **LITO**

## DRIVER 500mA 10W

10W | 500mA | 13-20V  
220-240VAC | 50-60Hz  
L/W/H 65x39x20  
☐ IP20 0.04kg CE 

**DEEP | DEEPER | DEEP ADJUST**  
1.0 | **DEEP ADJUST TRIMLESS**  
**DEEP ADJUST ASYM | DEEP IP65 | DEEPER IP44 | BLIEK ROUND | BLIEK SQUARE | RINI SNEAK IP44 | RON 1.0 | RONY STRANGE TRIMLESS 1.0 | PLANO 1.0 | PLANO IP44 | TAIO IP65 SNEAK 1.0 | SNEAK TRIMLESS 1.0**

CODE

90214201

CODE

90214406

## DRIVER 500mA 6.5W DIM

6.5W | preset at 500mA  
7-13V | phase-cut dim  
220-240VAC | 50-60Hz | 10-100%  
L/W/H 122x41x23  
☐ IP20 0.07kg CE 

**DEEP BIJOU IP65 | PIRRO 1.0**

## DRIVER 500mA 10W DIM

10W | 500mA | 12-21V | phase-cut dim  
220-240VAC | 50-60Hz  
L/W/H 115x41x25  
☐ IP20 0.08kg CE 

**DEEP | DEEPER | DEEP ADJUST**  
1.0 | **DEEP ADJUST TRIMLESS**  
**DEEP ADJUST ASYM | RONY RON 1.0 | PLANO 1.0 | STRANGE TRIMLESS 1.0 | SNEAK 1.0 | SNEAK TRIMLESS 1.0**  
**BLIEK ROUND**  
**BLIEK SQUARE | PIRRO 2.0**  
**DEEP IP65 | DEEPER IP44 | TAIO IP65 | RINI SNEAK IP44 | PLANO IP44 | PERLEZ IP44**

## DRIVER 500mA 20W DIM

20W | preset at 500mA  
26-38V | phase-cut dim  
220-240VAC | 50-60Hz | 10-100%  
L/W/H 138x44x30  
☐ IP20 0.01kg CE 

**DEEP ADJUST 2.0 | PIRRO 4.0,6.0**  
**PLANO 2.0 | RON 2.0 | STRANGE TRIMLESS 2.0 | SNEAK 2.0**  
**SNEAK TRIMLESS 2.0**



CODE

90224403

CODE

90224602

## DRIVER 500mA 10W 1-10V DIM

10W | 500mA | 10-20V | 1-10V dim  
220-240VAC | 50-60Hz | 10-100%  
L/W/H 102x51x30  
☐ IP20 0.06kg CE  

CODE

90234401

## DRIVER 500mA 24W DALI

24W | preset at 500mA | 6-49V  
DALI-2 | push dim | 220-240VAC  
50-60Hz | 1-100%  
L/W/H 143x43x30  
☐ IP20 0.13kg CE 

**DEEP | DEEPER | DEEP ADJUST**  
1.0, 2.0 | **DEEP ADJUST TRIMLESS**  
**DEEP ADJUST ASYM | RONY RON 1.0, 2.0 | PLANO | STRANGE TRIMLESS | SNEAK | SNEAK TRIMLESS**

CODE

90244701

## DRIVER 500mA 7W IP67

7W | 500mA | 5-14.5V  
90-295VAC | 47-63Hz  
L/W/H 57x41x24  
☐ IP67 0.15kg CE 

**DEEP BIJOU IP65 | ORIS 0.7, 0.8, 1.3, 2.0**

CODE

90214301

## DRIVER 500mA 24W IP68



24W | 500mA | 5-49V  
99-264VAC | 50-60Hz  
L/W/H 122x54x26  
☐ IP68 0.25kg CE 

**DEEP IP65 | DEEPER IP44**  
**TAIO IP65**

CODE

90214702

## DRIVER 700mA 6W

6W | 700mA | 3-8.4V  
90-264VAC | 50-60Hz  
L/W/H 68x35x21  
☐ IP20 0.04kg CE  

**STRIPE | THEMIS | STRANGE TRIMLESS** wall | **ORIS 0.7, 0.8**

## DRIVER 700mA 10W DIM

10W | preset at 700mA  
8-14V | phase-cut dim  
220-240VAC | 50-60Hz | 10-100%  
L/W/H 122x41x23  
☐ IP20 0.08kg CE 

CODE

90215203

CODE

90225402

## DRIVER 700mA 15W DIM

15W | preset at 700mA  
12-20V | phase-cut dim  
220-240VAC | 50-60Hz | 10-100%  
L/W/H 122x41x23  
☐ IP20 0.08kg CE 

**MATCH 2.0 | CENO 2.0 | BLIEK PETIT 2.0**

## DRIVER 700mA 20W DIM

20W | preset at 700mA  
15-28V | phase-cut dim  
220-240VAC | 50-60Hz | 10-100%  
L/W/H 138x44x30  
☐ IP20 0.11kg CE 

**CENO 3.0**

CODE

90225502

CODE

90225604

## DRIVER 700mA 30W DIM

30W | preset at 700mA  
26-42V | phase-cut dim  
220-240VAC | 50-60Hz | 10-100%  
L/W/H 138x44x30  
☐ IP20 0.14kg CE 

**DEEP ADJUST FORT**

CODE

90225702

## DRIVER 700mA 28W DALI



28W | preset at 700mA | 6-40V  
DALI-2 | push dim | 220-240VAC  
50-60Hz | 1-100%  
L/W/H 143x43x30  
☐ IP20 0.13kg CE 

**DEEP ADJUST FORT | MATCH 2.0**  
**CENO 2.0,3.0 | BLIEK PETIT 2.0**

CODE

90245704

## DRIVER 700mA 7W IP67

7W | 700mA | 3-10.5V  
90-295VAC | 47-63Hz  
L/W/H 57x41x24  
☐ IP67 0.07kg CE  

**ORIS 0.7, 0.8, 1.3, 2.0**

CODE

90215301

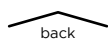

## DRIVER 12V/10W

10W | 12V | phase-cut dim  
220-240VAC | 50-60Hz | 3-10VA  
L/W/H 102x51x30  
☐ IP20 0.10kg C E 

**DEEP MR16 | DEEPER MR16**  
**DEEP ADJUST MR16 | DEEP**  
**ADJUST TRIMLESS MR16 | DEEP**  
**IP44 MR16 | DEEPER IP44 MR16**  
**RINE SNEAK IP44 MR16 | PLANO**  
**IP44 MR16**

## DRIVER 12V/25W

25W | 12V | phase-cut dim  
220-240VAC | 50-60Hz | 8-25VA  
L/W/H 145x51x30  
☐ IP20 0.10kg C E 

**DEEP MR16 | DEEPER MR16**  
**DEEP ADJUST MR16 | DEEP**  
**ADJUST TRIMLESS MR16 | DEEP**  
**IP44 MR16 | DEEPER IP44 MR16**  
**RINE SNEAK IP44 MR16 | PLANO**  
**IP44 MR16**

## DRIVER 24V/25W

2.4-25W | 24V | phase-cut dim | trailing  
edge only | 220-240VAC | 50-60Hz  
L/W/H 128x52x30  
☐ IP20 0.11kg C E 



**ILANE**

## DRIVER 24V/35W



35W | 24V | PWM dim  
220-240VAC | 50-60Hz  
L/W/H 142x43x30  
☐ IP20 0.14kg C E 

**ILANE**

## WIRE THROUGH CONNECTOR BOX

3 pole  
L/W/H 105x58x30  
☐ IP20  min.66 0.06kg C E 

## WIRE THROUGH CONNECTOR BOX

3 pole + DALI  
L/W/H 105x58x30  
☐ IP20  min.66 0.07kg C E 

CODE  
.....  
90221401

CODE  
.....  
90221701

CODE  
.....  
90222701

CODE  
.....  
90212801

CODE  
.....  
90059145

CODE  
.....  
90059146

## DRIVER 24V/50W

12-50W | 24V | phase-cut dim | trailing  
edge only | 220-240VAC | 50-60Hz  
L/W/H 184x61x32  
☐ IP20 0.24kg C E 

**ILANE**

## DRIVER 24V/100W

100W | 24V | PWM dim  
220-240VAC | 50-60Hz  
L/W/H 295x43x30  
☐ IP20 0.23kg C E 

**ILANE**

## DRIVER 24V/100W DALI

100W | 24V | DALI  
220-240VAC | 50-60Hz  
L/W/H 295x43x30  
☐ IP20 0.25kg C E 

**ILANE**

## DRIVER 24V/35W IP67

35W | 24V  
100-277VAC | 50-60Hz  
L/W/H 175x31x43  
☐ IP67 0.56kg C E 

**RETO** outdoor

## PAR16 FLAT HEAD

PAR16 | GU10  
220-240VAC | 50-60Hz  
IP20 0.06kg C E

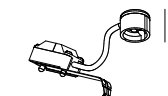

## CONNECTION BOX 3P PAR16

incl. strain relief | 3 pole push  
connector | incl. PAR16 socket  
incl. through-wiring  
L/W/H 75x35x25  
0.08kg

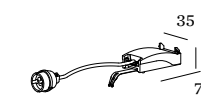

CODE  
.....  
90222901

CODE  
.....  
90212902

CODE  
.....  
90242901

CODE  
.....  
90212802

CODE  
.....  
90059125

CODE  
.....  
90059126

## DRIVER 24V/100W IP67

100W | 24V  
100-277VAC | 50-60Hz  
L/W/H 178x68x39  
☐ IP67 0.83kg C E 

**RETO** outdoor

## DRIVER 48V/100W

100W | 48V  
220-240VAC | 50-60Hz  
L/W/H 350x30x18  
☐ IP20 0.18kg C E 

**STREX SYSTEM**

## DRIVER 48V/150W

150W | 48V  
220-240VAC | 50-60Hz  
L/W/H 350x30x18  
☐ IP20 0.28kg C E 

**STREX SYSTEM**

## DRIVER 48V/250W

250W | 48V  
220-240VAC | 50-60Hz  
L/W/H 400x40x22  
☐ IP20 0.50kg C E 

**STREX SYSTEM**

## DALI TO PHASE-CUT DIMMING MODULE

for converting a DALI signal  
to phase-cut dim  
LED | 10-300W | 230V  
L/W/H 120x30x22  
☐ IP20 0.05kg C E

## DIMMER DIN RAIL

max. 200W LED | 230V  
phase-cut dim  
L/W/H 17x55x90  
IP30 0.09kg C E

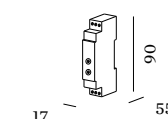

## DIMMER FOR SWITCH

max. 200W LED | 230V  
phase-cut dim  
L/W/H 48x17.5x46  
IP30 0.09kg C E



CODE  
.....  
90212903

CODE  
.....  
90218901

CODE  
.....  
90218902

CODE  
.....  
90218903

CODE  
.....  
90270901

CODE  
.....  
90019018

CODE  
.....  
90019017

## LED MODULE HO

12W | 350mA | 35Vf  
1800-3000K | CRI >90 | 1050lm  
compatibility on request  
IP20 0.06kg CE A 26°



CODE

905251W9  
905251B9

## LED MODULE HO 2700K

12W | 350mA | 35Vf  
2700K | CRI >90 | 1340lm  
compatibility on request  
IP20 0.06kg CE A 26°



CODE

905251W3  
905251B3

## LED MODULE HO 3000K

12W | 350mA | 35Vf  
3000K | CRI >90 | 1410lm  
compatibility on request  
IP20 0.06kg CE A 26°



CODE

905251W5  
905251B5

## LED MODULE HO 4000K

12W | 350mA | 35Vf  
4000K | CRI >90 | 1420lm  
compatibility on request  
IP20 0.06kg CE A 26°



CODE

905251W7  
905251B7

## LED MODULE CABLE

extension cable between LED module and driver

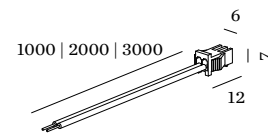

CODE

1m 90019200  
2m 90019201  
3m 90019202

## PAR16 LED 2700K

6.5W | GU10 | phase-cut dim  
175-250VAC | 50-60Hz  
2700K | CRI >90 | 460lm  
IP20 0.08kg CE A 35°



CODE

901228W3

## PAR16 LED 2700K

6.5W | GU10 | phase-cut dim  
220-240VAC | 50-60Hz  
2700K | CRI >90 | 437lm |  
IP20 0.08kg CE A 35°



CODE

901228B3

## PAR16 LED 3000K

6.5W | GU10 | phase-cut dim  
175-250VAC | 50-60Hz  
3000K | CRI >90 | 500lm  
IP20 0.08kg CE A 35°



CODE

901228W5

## PAR16 LED 3000K

6.5W | GU10 | phase-cut dim  
220-240VAC | 50-60Hz  
3000K | CRI >90 | 457lm  
IP20 0.08kg CE A 35°



CODE

901228B5

## PAR16 LED 2700K

4.3W | GU10  
220-240VAC | 50-60Hz  
2700K | CRI >80 | 350lm  
IP20 0.06kg CE A 36°



CODE

905227S2

## PAR16 LED 3000K

4.3W | GU10  
220-240VAC | 50-60Hz  
3000K | CRI >80 | 350lm  
IP20 0.06kg CE A 36°



CODE

905227S4

## METAL SPRING CLIP

alternative front lamp fixation spring for ø 50 lamp rings  
MR16 | LED | PAR16 | max. 12W  
**DEEP ADJUST | DEEP ASYM**  
**DEEP 2.0 | PLANO | STRANGE**  
ceiling | **SPINEO | SOLID**



CODE

90019700

## SPRING CLIP

lamp fixation | push-in system for ø 50 lamp rings  
MR16 | LED | PAR16 | max. 12W  
**DEEP ADJUST | DEEP ASYM**  
**DEEP 2.0 | PLANO | STRANGE**  
ceiling | **SPINEO | SOLID**

CODE

900198W0  
900198S0  
900198G0  
900198M0  
900198Q0  
900198B0



## QT14 LED 2700K

2.6W | G9 | phase-cut dim  
220-240VAC | 50-60Hz  
2700K | CRI >80 | 300lm  
**DRO 1.0**  
IP20 0.03kg €€

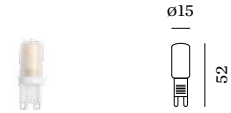

CODE

clear 9010G802

## QT14 LED 3000K

3W | G9 | 220-240VAC | 50Hz  
3000K | CRI >80 | 300lm  
**RAY** wall | **BOX** wall  
IP20 0.03kg €€



CODE

clear 9019G703

## QT14 LED 3000K

3.1W | G9 | phase-cut dim  
220-240VAC | 50-60Hz  
3000K | CRI >80 | 280lm  
**DRO 1.0**  
IP20 0.03kg €€



CODE

clear 9010G804

## C35 LED 2700K

5.5W | E14 | phase-cut dim | 20-100%  
220-240VAC | 50-60Hz  
2700K | CRI >90 | 450lm  
**DRO 2.0**  
IP20 0.03kg €€



CODE

opal 9003C103

## A60 LED 2700K

9W | E27 | phase-cut dim  
220-240VAC | 50-60Hz  
2700K | CRI >90 | 800lm  
**DRO 3.0** | **ROOMOR** suspended  
**SHIEK** | **BISHOP**  
IP20 0.04kg €€



CODE

opal 9003E152

## A65 LED 2700K

14.6W | E27 | phase-cut dim  
220-240VAC | 50-60Hz  
2700K | CRI >90 | 1378lm  
**DRO 4.0**  
IP20 0.04kg €€

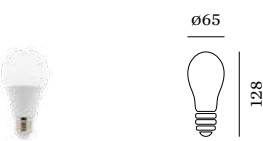

CODE

opal 9003E153

## G95 LED 2700K

11.2W | E27 | phase-cut dim  
220-240VAC | 50-60Hz  
2700K | CRI >90 | 1100lm  
**BISHOP**  
IP20 0.11kg €€

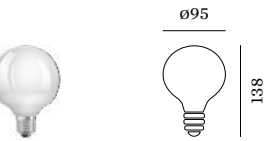

CODE

opal 9003E154

## G95 LED 2200K

5.4W | E27 | phase-cut dim  
220-240VAC | 50-60Hz  
2200K | CRI >95 | 380lm  
**RUVI** | **BISHOP**  
IP20 0.07kg €€



CODE

gold tinted 9003E111

## G95 LED 2700K

5.5W | E27 | phase-cut dim  
220-240VAC | 50-60Hz  
2700K | CRI >90 | 534lm  
**TRACE SUSPENDED 2.1**  
IP20 0.07kg €€



CODE

clear 9003E160

## ST64 LED 2200K DIM

5.9W | E27 | phase-cut dim  
220-240VAC | 50-60Hz  
2200K | CRI >95 | 433lm  
IP20 0.05kg €€



CODE

gold tinted 9003E110

## G125 LED 2200K

6.2W | E27 | phase-cut dim  
220-240VAC | 50-60Hz  
2200K | CRI >95 | 450lm  
IP20 0.11kg €€

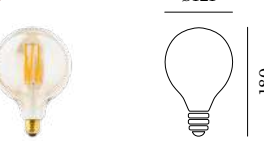

CODE

gold tinted 9003E112

## A60 LED 2700K

5.5W | E27 | phase-cut dim  
220-240VAC | 50-60Hz  
2700K | CRI >90 | 409lm  
**MIRRO 1.0**  
IP20 0.04kg €€



CODE

gold mirror 9003E139  
silver mirror 9003E140

## G95 LED 2200K

5.1W | E27 | phase-cut dim  
220-240VAC | 50-60Hz  
2200K | CRI >95 | 371lm  
**MIRRO 2.0, 3.0** | **RUVI**  
IP20 0.07kg €€

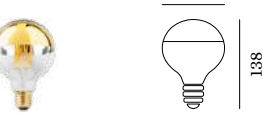

CODE

gold mirror 9003E142  
silver mirror 9003E157

## G95 LED 2700K

5.6W | E27 | phase-cut dim  
220-240VAC | 50-60Hz  
2700K | CRI >90 | 464lm  
**MIRRO 2.0, 3.0** | **RUVI**  
IP20 0.07kg €€

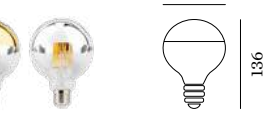

CODE

gold mirror 9003E142  
silver mirror 9003E157

## T30-225 LED 2200K

5.3W | E27 | phase-cut dim  
220-240VAC | 50-60Hz  
2200K | CRI >90 | 382lm  
**WIRO 1.8, 3.8** | wall | **CONE**  
**DIAMOND** | **GLOBE 4.0**  
IP20 0.06kg €€



CODE

gold tinted 9003E129

## T30-225 LED 2700K

5.3W | E27 | phase-cut dim  
220-240VAC | 50-60Hz  
2700K | CRI >90 | 425lm  
**WIRO 1.8, 3.8, 6.1, 6.5** | wall  
**CONE** | **GLOBE 4.0**  
IP20 0.06kg €€



CODE

gold tinted 9003E136

## T30-300 LED 2200K

7.2W | E27 | phase-cut dim  
220-240VAC | 50-60Hz  
2200K | CRI >90 | 585lm  
**WIRO 6.1, 6.5** | **DIAMOND**  
**GLOBE 1.0, 2.0, 5.0**  
IP20 0.08kg €€



CODE

gold tinted 9003E130

## T30-300 LED 2700K

7.4W | E27 | phase-cut dim  
220-240VAC | 50-60Hz  
2700K | CRI >90 | 613lm  
**WIRO 6.1, 6.5** | **DIAMOND**  
**GLOBE 1.0, 2.0, 5.0**  
IP20 0.08kg €€



CODE

gold tinted 9003E135

# ACCESSORIES

Accessories

**HONEYCOMB LOUVER**  
BLIEK PETIT | CENO | LECA  
PIRRO



CODE  
90051131

**HONEYCOMB LOUVER**  
CENO FORT

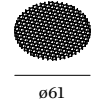

CODE  
90051132

**ODREY**  
inner cover for 1.6 | 1.7

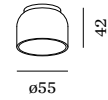

CODE  
911420W0  
911420G0  
911420B0

**CORK**  
bottle 1 | clear glass



CODE  
90019013

**CORK**  
bottle 2 | clear glass with closing cap

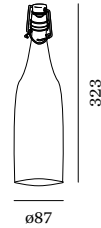

CODE  
90019014

**FINLIN COVER PLATE**  
ADAPTER  
for concrete housings

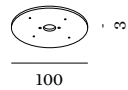

CODE  
900194B0

**FINLIN**  
wall/base spacer for overlapping  
luminaires

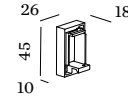

CODE  
900195B0

**FINLIN ROUND**  
wall/base spacer for overlapping  
luminaires

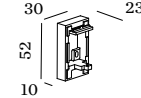

CODE  
900196B0

**BOX | RAY**  
flaps for adjustable beam angle  
white | for BOX/RAY QT14 only

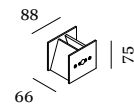

CODE  
900401W0

**STAKE**  
snoot

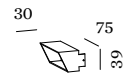

CODE  
90019004

**X-BEAM**  
snoot

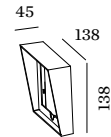

CODE  
90019023

**X-BEAM**  
snoot round

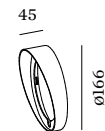

CODE  
90019031

**DEEP ADJUST PETIT**  
TRIMLESS | BLIEK PETIT  
TRIMLESS

aluminium plasterkit  
⌀ 78-80 | 80 | 12.5, 15, 20, 25

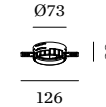

CODE  
90017210

**DEEP ADJUST TRIMLESS**  
aluminium plasterkit  
⌀ 105-110 | 12.5, 15, 20, 25

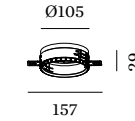

CODE  
90017209

**STRANGE PETIT**  
TRIMLESS 1.0  
aluminium plasterkit  
64x64 | 7-32

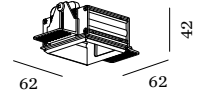

CODE  
90017202

**STRANGE PETIT**  
TRIMLESS 2.0  
aluminium plasterkit  
64x117 | 7-32

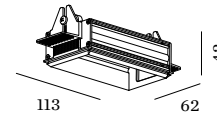

CODE  
90017205

**STRANGE PETIT**  
TRIMLESS 3.0  
aluminium plasterkit  
64x169 | 7-32

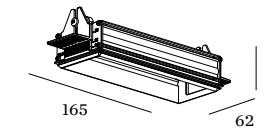

CODE  
90017208

**STRANGE TRIMLESS 1.0**  
SNEAK TRIMLESS 1.0  
aluminium plasterkit  
186x86 | 7-32

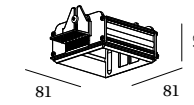

CODE  
90017120

**STRANGE TRIMLESS 2.0**  
SNEAK TRIMLESS 2.0  
aluminium plasterkit  
156x86 | 7-32

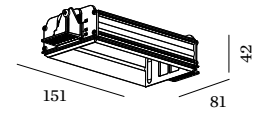

CODE  
90017121

**LITO**  
plasterkit



CODE  
90017119

# PLASTERKITS

Accessories

# RECESSED HOUSING

Accessories

**PLANO 1.0**  
plasterkit

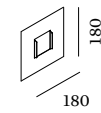

CODE  
90017104

**PLANO 2.0**  
plasterkit

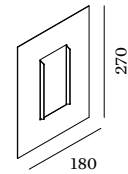

CODE  
90017105

**LITO**  
always use in combination with  
plasterkit  
122x90 11.45



CODE  
90012027

**THEMIS 1.7**  
always use in combination with  
plasterkit  
272x160 11.85

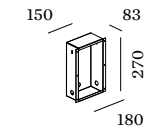

CODE  
90012032

**THEMIS 2.7**  
always use in combination with  
plasterkit  
372x160 11.85

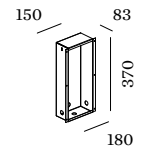

CODE  
90012033

**STRIPE 0.4 | 0.7**  
recessed housing incl. plasterkit  
75x75 11.65

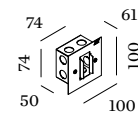

CODE  
90012037

**STRIPE 2.2**  
recessed housing incl. plasterkit  
251x76 11.65

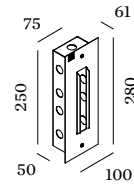

CODE  
90012038

**THEMIS 1.7**  
plasterkit

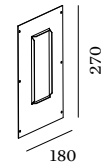

CODE  
90017111

**THEMIS 2.7**  
plasterkit

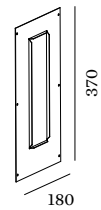

CODE  
90017112

**ORIS 0.7 | RETO 2.0**  
concrete housing  
192x58 11.60

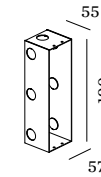

CODE  
90012044

**ORIS 0.8 | RETO 0.8**  
concrete housing  
70x70 11.65

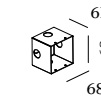

CODE  
90012046

**ORIS 1.3 | RETO 1.3**  
concrete housing  
122x122 11.60

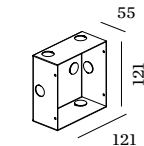

CODE  
90012040

**ORIS 2.0**  
concrete housing  
123x191 11.60

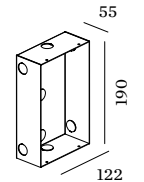

CODE  
90012042

**ORIS 0.7 | RETO 2.0**  
recessed housing incl. plasterkit  
191x58 11.75

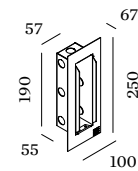

CODE  
90012039

**ORIS 0.8 | RETO 0.8**  
recessed housing incl. plasterkit  
70x70 11.80

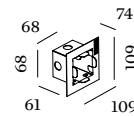

CODE  
90012047

**ORIS 1.3 | RETO 1.3**  
recessed housing incl. plasterkit  
122x122 11.75

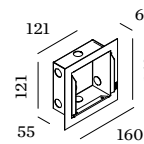

CODE  
90012041

**ORIS 2.0**  
recessed housing incl. plasterkit  
123x191 11.75

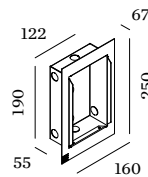

CODE  
90012043

**MAP 0.6 | CHART 0.6**  
**BLINK | TRIMLESS**  
ground housing  
137 11.10

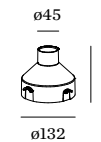

CODE  
90012201

**MAP 0.9 | CHART 0.9**  
ground housing  
137 11.130

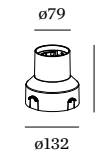

CODE  
90012202

**MAP 1.2 | CHART 1.2**  
**MAP ASYM 1.2 | CHART**  
**ASYM 1.2**  
ground housing  
190 11.158

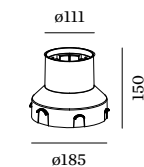

CODE  
90012203

**MAP 1.6 | CHART 1.6**  
**MAP ASYM 1.6 | CHART**  
**ASYM 1.6**  
ground housing  
220 11.184

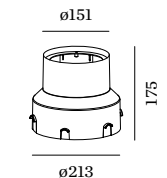

CODE  
90012204

Rev. 001/2024-05

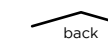

back

# ILANE

Accessories

# STREX SYSTEM

Accessories

## DALI SELV DEVICE

for 48V system | max. 300W | 48VDC  
L/W/H 213x37x25

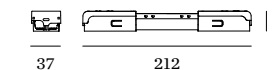

CODE

90019193

## ILANE BLACK DIFFUSER

only for 1.0

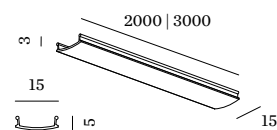

CODE

2m 911902B1

3m 911903B1

## ILANE BLACK DIFFUSER

only for 3.0

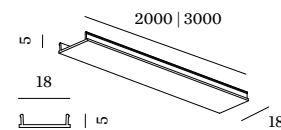

CODE

2m 911912B1

3m 911913B1

## RECESSED

track | custom cuts | 48V | 15A | DALI

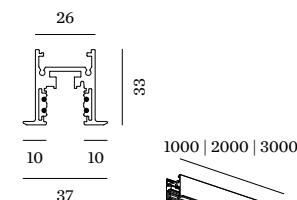

CODE

< 1m 90014187CC

< 1m 90014188CC

< 2m 90014189CC

< 2m 90014190CC

< 3m 90014191CC

< 3m 90014192CC

CC = for lengths specifications please add four digits in mm

## SURFACE

track | custom cuts | 48V | 15A | DALI

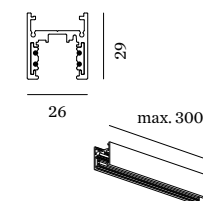

CODE

< 1m 90014181CC

< 1m 90014182CC

< 2m 90014183CC

< 2m 90014383CC

< 2m 90014384CC

< 2m 90014184CC

< 3m 90014185CC

< 3m 90014385CC

< 3m 90014386CC

< 3m 90014186CC

CC = for lengths specifications please add four digits in mm

## SUSPENDED

track | custom cuts | 48V | 15A | DALI

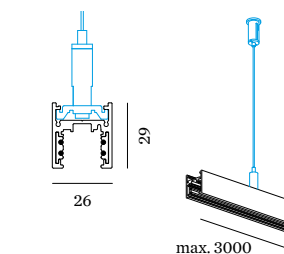

CODE

< 1m 90014181CC

< 1m 90014182CC

< 2m 90014183CC

< 2m 90014383CC

< 2m 90014384CC

< 2m 90014184CC

< 3m 90014185CC

< 3m 90014385CC

< 3m 90014386CC

< 3m 90014186CC

CC = for lengths specifications please add four digits in mm

## SUSP. INDIRECT LIGHT

track | custom cuts | 48V | 15A | DALI  
with indirect light

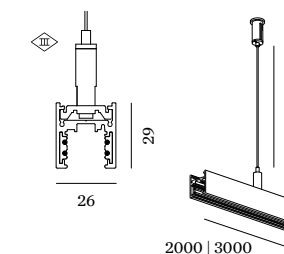

CODE

< 2m 900140W\_CC

< 2m 900140B\_CC

< 3m 900141W\_CC

< 3m 900141B\_CC

LIGHT COLOUR LUMEN|CRI CODE

3000K | 14W/m 950/m | >90 5

CC = for lengths specifications please add four digits in mm

## ILANE MINI CONNECTOR

strip to strip - continuous

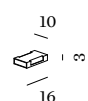

CODE

IP20 90014272

## ILANE MINI CONNECTOR

strip to wire

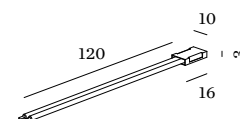

CODE

IP20 90014268

## ILANE MINI CONNECTOR

strip to strip

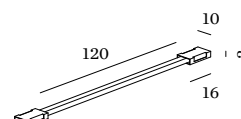

CODE

IP20 90014269

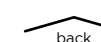

# 1-PHASE TRACK

Accessories

## TRACK ADAPTER 1.0

no space for driver  
for suspended luminaires without  
steel wire | incl. strain relief  
max. weight 10kg



CODE	
90014044	90014043

## TRACK ADAPTER 2.0

no space for driver  
for suspended luminaires without  
steel wire | incl. strain relief  
max. weight 3kg

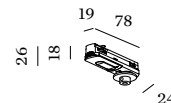

CODE	
90014277	90014278

## ADJUSTABLE CORNER

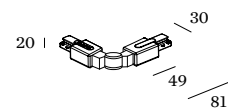

CODE	
90014042	90014041

## COVERPLATE I/L/T/X

only use with recessed tracks

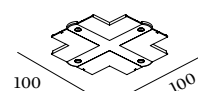

CODE	
90014126	90014127

## COVERPLATE END FEEDS

only use with recessed tracks

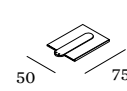

CODE	
90014124	90014125

## X-FEED

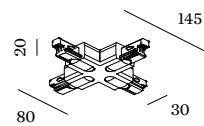

CODE	
90014049	90014050

## T-FEED 1.0

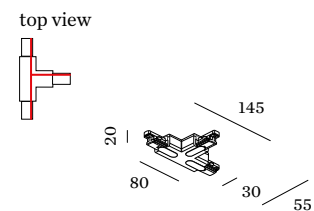

CODE	
90014010	90014011

## T-FEED 2.0

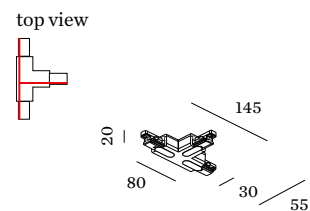

CODE	
90014012	90014013

## T-FEED 3.0

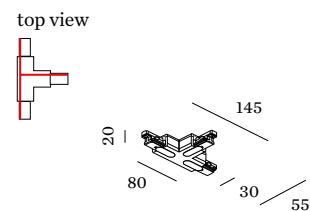

CODE	
90014014	90014015

## T-FEED 4.0

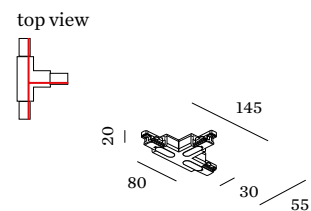

CODE	
90014016	90014017

## T-FEED 1.0

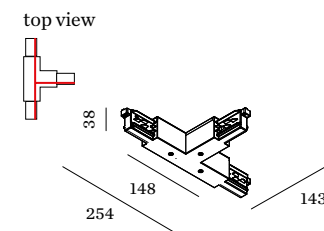

CODE	
90014228	90014229

## T-FEED 2.0

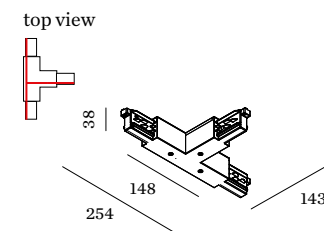

CODE	
90014230	90014231

## T-FEED 3.0

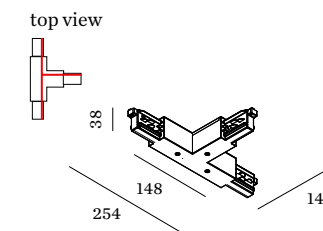

CODE	
90014232	90014233

## T-FEED 4.0

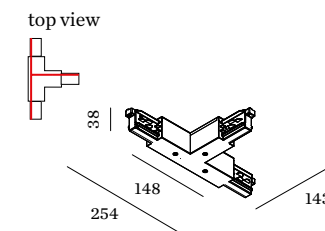

CODE	
90014234	90014235

# 3-PHASE TRACK

Accessories

## CUTTING TOOL

for cutting the inner copper cables of  
3-phase track and 48V track  
CE TÜV

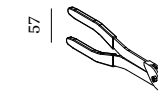

CODE	
90014165	

## TRACK ADAPTER

no space for driver  
for suspended luminaires without  
steel wire | incl. strain relief  
max. weight 5kg

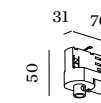

CODE	
90014279	90014280

## HOOK

max. weight 5kg

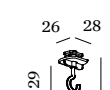

CODE	
90014284	90014285

## FLEXIBLE CONNECTOR

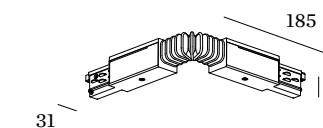

CODE	
90014288	90014289

## X-FEED

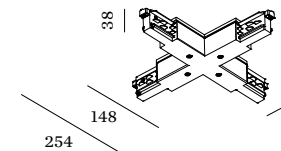

CODE	
90014248	90014249

# SUSPENSION OPTIONS

Accessories

## SOLLI COCOON 3.0

acoustic element  
aluminium | PET felt material

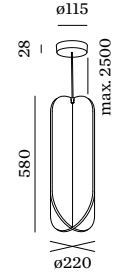

CODE

	238500MF0
	238500LF0
	238500OF0

## HOOK

for cable 4.25-5.5mm diameter | for single and multi suspension | also for textile cable

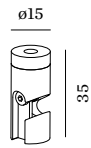

CODE

	90052079
	90052080

## HOOK

standard multi suspension hook for ø5 plugs

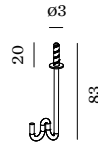

CODE

	90052025
	90052024

## HOOK

optional multi suspension hook for ø6 plugs

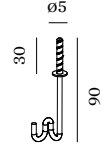

CODE

	90052066
	90052065

## SHIEK 4.0

cable ring for 3 luminaires

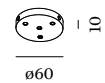

CODE

	90059123
	90059121

## STRAIN RELIEF

for suspended luminaire power cable fixation in base

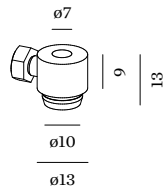

CODE

	90052064
--	----------

## CABLE WALL/CEILING BRACKET

for cable 4.25-5.5mm diameter

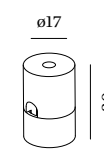

CODE

	90019197
	90019198

# WIRO SUSPENDED

Accessories

## WIRO

cable wall bracket only for WIRO textile cable

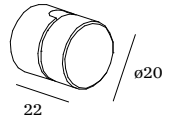

CODE

	90052062
--	----------

## CABLE PLUG AND PLAY

E27 LED 4-25W | connector set for one shade | black textile cable | incl. cable plug with dimmer | 2 cable brackets included

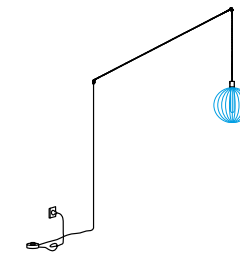

CODE

	8.5m	90015165
--	------	----------

## DECENTER SET 1.0

A60 max. 60W | E27  
220-240VAC | 50-60Hz  
suspension set for 1 shade  
round ceiling base | black textile cable  
1 base + 1 end stop included

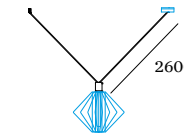

CODE

	2.6m	90052050
--	------	----------

## DECENTER SET 1.0

A60 max. 60W | E27  
220-240VAC | 50-60Hz  
suspension set for 1 shade  
round ceiling base | black textile cable  
1 base + 1 end stop included

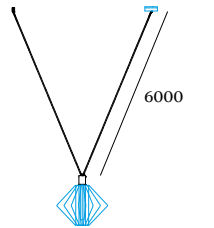

CODE

	6m	90052051
--	----	----------

## DECENTER SET 2.0

2x A60 max. 60W | E27  
220-240VAC | 50-60Hz  
suspension set for 2 shades  
round ceiling base | black textile cable  
1 multibase + 2 end stops included

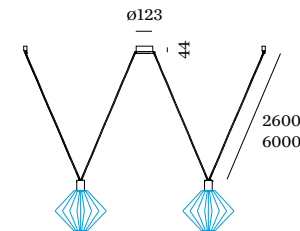

CODE

	2.6m	90052055
	6m	90052056

## DECENTER SET 3.0

3x A60 max. 60W | E27  
220-240VAC | 50-60Hz  
suspension set for 3 shades  
round ceiling base | black textile cable  
1 multibase + 3 end stops included

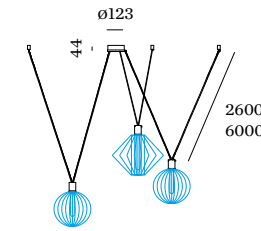

CODE

	2.6m	90052060
	6m	90052063

## DECENTER SET 4.0

4x A60 max. 60W | E27  
220-240VAC | 50-60Hz  
suspension set for 4 shades  
round ceiling base | black textile cable  
1 multibase + 4 end stops included

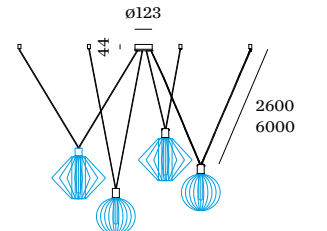

CODE

	2.6m	90052067
	6m	90052078

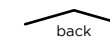

back

**KIOSK POLE 400**  
straight pole | incl. ground spike

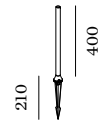

CODE	
400	910101A0
400	910101Q0

**KIOSK POLE 600**  
straight pole | incl. ground spike

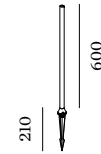

CODE	
600	910102A0
600	910102Q0

**KIOSK POLE 800**  
straight pole | incl. ground spike

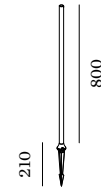

CODE	
800	910103A0
800	910103Q0

**SWAM POLE 400**  
straight pole | incl. ground spike

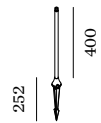

CODE	
	910090Q0
	910090B0

**SWAM POLE 600**  
straight pole | incl. ground spike

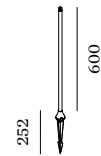

CODE	
	910091Q0
	910091B0

**SWAM POLE 800**  
straight pole | incl. ground spike

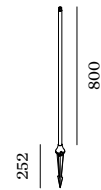

CODE	
	910092Q0
	910092B0

**STIPO POLE 200**  
with fixation plate | 3.0, 4.0

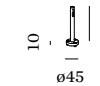

CODE	
	910062A0
	910062Q0

**STIPO POLE 400**  
with fixation plate | 3.0, 4.0

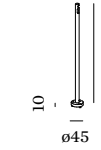

CODE	
	910064A0
	910064Q0

**STIPO POLE 600**  
with fixation plate | 3.0, 4.0

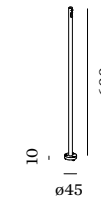

CODE	
	910066A0
	910066Q0

**SWAM POLE 400**  
curved pole | incl. ground spike

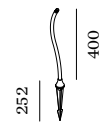

CODE	
	910093Q0
	910093B0

**SWAM POLE 600**  
curved pole | incl. ground spike

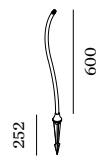

CODE	
	910094Q0
	910094B0

**SWAM POLE 800**  
curved pole | incl. ground spike

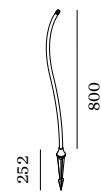

CODE	
	910095Q0
	910095B0

**KIOSK | SWAM**  
fixation plate



CODE	
	90019019

**STIPO | STAKE 1.0**  
ground spike

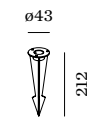

CODE	
	90013106

**STAKE FOLD**  
ground spike

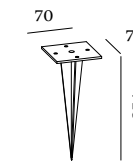

CODE	
	90013107

**X-BEAM**  
ground spike

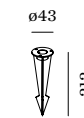

CODE	
	90013115

**TAPE**  
ground spike

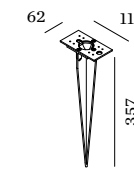

CODE	
	90013102

# POLE | GROUND FIXATION

Accessories

**POLE 170**  
with fixation plate  
**PALOS ROUND | PALOS CARRÉ**

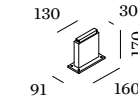

CODE	
	910013A0
	910013Q0
	910013B0

**POLE 170**  
with concrete ground fixation  
**PALOS ROUND | PALOS CARRÉ**

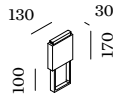

CODE	
	910073A0
	910073Q0
	910073B0

**GATE 1.0 POLE 250**  
pole with fixation plate



CODE	
	250 910121A0
	250 910121Q0

**GATE 1.0 POLE 450**  
pole with fixation plate

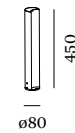

CODE	
	450 910122A0
	450 910122Q0

**GATE 1.0 POLE 650**  
pole with fixation plate

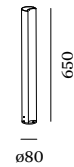

CODE	
	650 910123A0
	650 910123Q0

**POLE 270**  
with fixation plate  
**PALOS ROUND | PALOS CARRÉ**

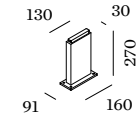

CODE	
	910014A0
	910014Q0
	910014B0

**POLE 270**  
with concrete ground fixation  
**PALOS ROUND | PALOS CARRÉ**

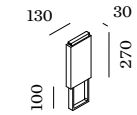

CODE	
	910074A0
	910074Q0
	910074B0

**POLE 470**  
with fixation plate  
**PALOS ROUND | PALOS CARRÉ**

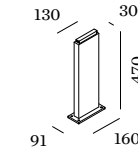

CODE	
	910016A0
	910016Q0
	910016B0

**POLE 470**  
with concrete ground fixation  
**PALOS ROUND | PALOS CARRÉ**

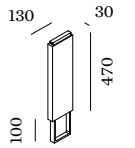

CODE	
	910076A0
	910076Q0
	910076B0

**GATE 2.0 POLE 250**  
pole with fixation plate

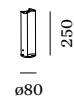

CODE	
	250 910124A0
	250 910124Q0

**GATE 2.0 POLE 450**  
pole with fixation plate

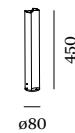

CODE	
	450 910125A0
	450 910125Q0

**GATE 2.0 POLE 650**  
pole with fixation plate



CODE	
	650 910126A0
	650 910126Q0

**POLE 670**  
with fixation plate  
**PALOS ROUND | PALOS CARRÉ**

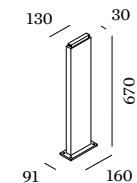

CODE	
	910018A0
	910018Q0
	910018B0

**POLE 670**  
with concrete ground fixation  
**PALOS ROUND | PALOS CARRÉ**

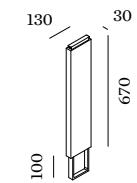

CODE	
	910078A0
	910078Q0
	910078B0

**POLE 870**  
with fixation plate  
**PALOS ROUND | PALOS CARRÉ**

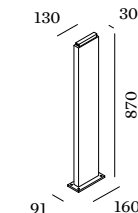

CODE	
	910010A0
	910010Q0
	910010B0

**POLE 870**  
with concrete ground fixation  
**PALOS ROUND | PALOS CARRÉ**

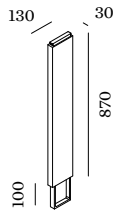

CODE	
	910070A0
	910070Q0
	910070B0

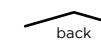

back



# POLE | GROUND FIXATION

Accessories

# GEO | REED | POLA

Accessories

**LINUS POLE 150**  
with fixation plate

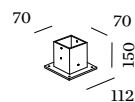

CODE

910024D0

910024A0

910024Q0

**LINUS POLE 350**  
with fixation plate

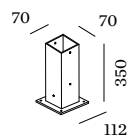

CODE

910026D0

910026A0

910026Q0

**LINUS POLE 550**  
with fixation plate

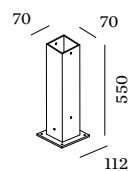

CODE

910028D0

910028A0

910028Q0

**LINUS**  
ground spike

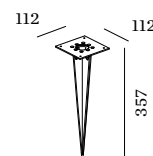

CODE

90013103

**LINUS**  
concrete ground fixation

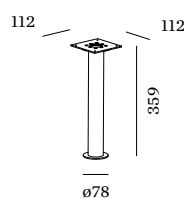

CODE

90013302

**PLUG & PLAY DRIVER 24V/24W IP67**

24W | 24V  
220-240VAC | 47-63Hz  
incl. 2.5m cable with 240V plug  
incl. 2.5m cable with 24V male plug  
L/W/H 118x35x26  
IP67 CE

GEO | REED | POLA

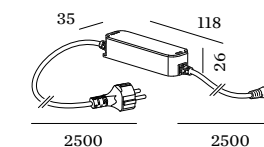

CODE  
90018014

**PLUG & PLAY DRIVER 24V/60W IP67**

60W | 24V  
220-240VAC | 47-63Hz  
incl. 2.5m cable with 240V plug  
incl. 2.5m cable with 24V male plug  
L/W/H 163x43x32  
IP67 CE

GEO | REED | POLA

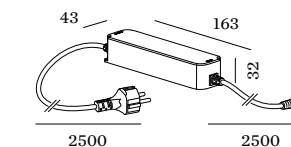

CODE  
90018015

**PLUG & PLAY EXTENSION CABLE**

2x 24V male plug  
IP67 H07RN-F CE

GEO | REED | POLA

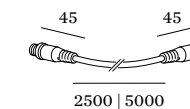

CODE  
2.5m 90014502  
5m 90014503

**PLUG & PLAY STRAIGHT CONNECTOR**

2x 24V female connector  
IP67 H07RN-F CE

GEO | REED | POLA

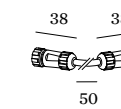

CODE  
90014504

**PLUG & PLAY T-CONNECTOR**

3x 24V female connector  
IP67 CE



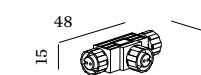











GEO | REED | POLA



CODE  
90014504

# Icons and standards

ICON	ENGLISH	GERMAN	DUTCH	FRENCH	SPANISH	ITALIAN
	Cutout Round	Ausschnitt rund	Ronde inbouwopening	Découpe ronde	Corte circular	Taglio tondo
	Cutout Square	Ausschnitt eckig	Rechthoekige inbouwopening	Découpe rectangulaire	Corte rectangular	Taglio quadro
	Recessed Depth	Einbautiefe	Inbouwdiepte	Profondeur d'encastrement	Profundidad de empotramiento	Profondità dell'incasso
	Low Recessed Depth	Geringe Einbautiefe	Lage inbouwdiepte	Encastré Profondeur faible	Reducida profundidad de empotramiento	Profondità dell'incasso ridotta
	Thickness	Stärke	Dikte	Épaisseur	Espesor	Spessore
	Rotatable vertically   horizontally	Drehbar vertikal   horizontal	Draaibaar verticaal   horizontaal	Orientable verticalement   horizontalement	Orientable en vertical   horizontal	Orientabile in verticale   orizzontale
	Beam Angle	Abstrahlwinkel	Reflectorhoek	Faisceau	Ángulo de apertura	Fascio luminoso
	Class 1 Fixture	Leuchte der Schutzklasse 1	Toestel klasse 1	Appareil classe 1	Aparato de clase 1	Lampada classe 1
	Class 2 Fixture	Leuchte der Schutzklasse 2	Toestel klasse 2	Appareil classe 2	Aparato de clase 2	Lampada classe 2
	Class 3 Fixture	Leuchte der Schutzklasse 3	Toestel klasse 3	Appareil classe 3	Aparato de clase 3	Lampada classe 3
	IP rating	IP Bewertung	IP rating	Indice de protection	Grado IP	Grado di protezione IP
	Frontal IP rating	Frontale IP Bewertung	Frontale IP-classificatie	Évaluation IP frontale	Grado IP en parte frontal	Grado di protezione IP frontale
	IK rating	Schlagfestigkeit	IK rating	IK rating	Grado IK	IK rating
	Screen-compatible workplace light	Bildschirmtaugliche Arbeitsplatzleuchte	Werkplekverlichting is compatibel met beeldscherm	Éclairage compatible pour écran d'ordinateur	Iluminación para puestos de trabajo compatible con pantallas	Adatta per ambienti di lavoro   uffici
	IC rated: may be covered with insulation material	IC Rated: kann mit Isoliermaterial abgedeckt werden	IC classificatie; kan worden bedekt met isolatiemateriaal	Classé IC: peut être recouvert d'un matériau isolant	Clasificación IC: puede cubrirse con material aislante	Protezione IC. Può essere coperto con materiale isolante
	LED Lifetime: Lumen output is minimum 80% after 50.000 hours	LED-Lebensdauer: Die Lichtausbeute nach 50.000 Stunden beträgt mindestens 80 %	Led-levensduur: de lichtopbrengst na 50.000 uur is minimaal 80%	Durée de vie des LED: l'efficacité lumineuse au bout de 50 000 heures s'élève à 80 % minimum	Vida útil de los LED: la eficiencia luminosa tras 50.000 horas es de al menos el 80 %	Durata dei LED: l'efficienza luminosa è pari ad almeno l'80% dopo 50.000 ore di funzionamento
	Standard Deviation Colour Matching	Standardabweichung des Farbgleichs	Standaarddeviatie van kleurafstemming	Écart-type de la correspondance des couleurs	Desviación estándar de la coincidencia de colores	Deviazione standard del bilanciamento del colore

ICON	ENGLISH	GERMAN	DUTCH	FRENCH	SPANISH	ITALIAN
	CE conform	CE-konform	CE-conform	Conformité CE	Conformidad CE	Conformità CE
	ENEC Certificate	ENEC Zertifikat	ENEC Certificaat	Certificat ENEC	Certificado ENEC	Certificato ENEC
	UL Certificate	UL Zertifikat	UL Certificaat	Certificat UL	Certificado UL	Certificato UL
	Colour Temperature	Farbtemperatur	Kleurtemperatuur	Température de couleur	Temperatura de color	Temperatura colore
	Part not included	Teil nicht inkludiert	Niet inbegrepen	Pièce non comprise	Parte no incluida	Articolo non incluso
	Up/Down	Aufwärts/abwärts strahlend	Verlichting up of down	Éclairage haut ou bas	Emisión superior/ inferior	Luce monoemissione sopra/sotto
	Up and Down	Direkt und indirekt abstrahlend	Verlichting up en down	Éclairage haut et bas	Emisión superior e inferior	Luce biemissione sopra/sotto
	Energy labelling regulation	Verordnung über die Energiekennzeichnung	Energie-etiketterings-verordening	Règlement sur l'étiquetage énergétique	Reglamento sobre el etiquetado energético	Regolamento sull'etichettatura energetica
	Light source replaceable by end user	Lichtquelle durch Endverbraucher austauschbar	Lichtbron door eindgebruiker te vervangen	Source lumineuse remplaçable par l'utilisateur final	Fuente luminosa sustituable por el usuario	Sorgente luminosa sostituibile dall'utente finale
	Light source not replaceable	Lichtquelle nicht austauschbar	Lichtbron niet te vervangen	Source lumineuse non remplaçable	Fuente luminosa no sustituable	Sorgente luminosa non sostituibile
	Control gear replaceable by end user	Betriebsgerät durch Endverbraucher austauschbar	Driver door eindgebruiker te vervangen	Dispositif de commande remplaçable par l'utilisateur final	Mecanismo de control sustituable por el usuario	Dispositivo di controllo sostituibile dall'utente finale
	Control gear not replaceable	Betriebsgerät nicht austauschbar	Driver niet te vervangen	Dispositif de commande non remplaçable	Mecanismo de control no sustituable	Dispositivo di controllo non sostituibile
	Light source replaceable by authorized professional	Lichtquelle durch autorisierte Fachleute austauschbar	Lichtbron door erkende vakmensen te vervangen	Source lumineuse remplaçable par un professionnel agréé	Fuente luminosa sustituable por un técnico autorizado	Sorgente luminosa sostituibile da tecnici specializzati
	Control gear replaceable by authorized professional	Betriebsgerät durch autorisierte Fachleute austauschbar	Driver door erkende vakmensen te vervangen	Dispositif de commande remplaçable par un professionnel agréé	Mecanismo de controls sustituable por un técnico autorizado	Dispositivo di controllo sostituibile da tecnici specializzati
	Check product availability on weverducre.com	Informationen zur Verfügbarkeit der Produkte finden Sie auf weverducre.com	Controleer de productbeschikbaarheid op weverducre.com	Vérifier la disponibilité des produits sur weverducre.com	Compruebe la disponibilidad de los productos en weverducre.com	Le informazioni relative alla disponibilità dei prodotti sono consultabili su weverducre.com

# Contact

## REPRESENTATIVE OFFICES

### UAE

Office No. 704, HDS Business Center  
Cluster M  
Jumeirah Lakes Towers, DMCC  
PO Box 336603 Dubai  
United Arab Emirates  
Phone +971 4 436 23 47  
office.me@weverducre.com

### NETHERLANDS

Design Post Amsterdam  
Cruquiusweg 111L  
1019, AG Amsterdam  
Phone +31 20 229 6001  
info.nl@weverducre.com

### NORWAY

Drammensveien 288  
0283 Oslo  
Phone +47 24 07 61 11  
office.no@weverducre.com

### SWITZERLAND

Sonnmatthof 3  
6023 Rothenburg  
Phone +41 41 361 60 60  
office.ch@weverducre.com

### INDIA

1524, Astralis, Supernova, Sector-94  
201301, Noida, Uttar Pradesh  
Phone +91 85 3013 0555  
office.in@weverducre.com

## HEAD OFFICE + SHOWROOM

### WEVER & DUCRÉ BV

Spinnerijstraat 99/21  
8500 Kortrijk  
Belgium  
Phone +32 56 492 800  
office@weverducre.com  
weverducre.com

## SHOWROOMS

### HONG KONG

RM. 1413, Block A, Sea View Estate  
2 Watson Road North Point | Hong Kong  
Phone +852 211 069 24  
Fax +852 310 640 96  
office.hk@weverducre.com  
office.cn@weverducre.com

### AUSTRIA

Gleisdorfer Gasse 15  
8010 Graz  
Phone +43 316 317 085 91  
office.at@weverducre.com

### BELGIUM

Marxergasse 1B  
1030 Vienna  
Phone +43 1 526 47 84  
office.at@weverducre.com

### BELGIUM

Gare Maritime  
Picardstraat 7, bus 304  
1000 Brussels  
Phone +32 56 492 800  
office@weverducre.com

### FINLAND

Sörnäistenkatu 1  
00580 Helsinki  
Phone +358 50 506 71 82  
office.fi@weverducre.com

### FRANCE

36, Rue Juliette Récamier  
69006 Lyon  
Phone +33 4 72 811 199  
office.fr@weverducre.com

### FRANCE

10, Rue Pecquay  
75004 Paris  
Phone +33 1 402 981 01  
office.fr@weverducre.com

### GERMANY

Europa-Allee 18  
60327 Frankfurt am Main  
Phone +49 692 10295 90  
office.de@weverducre.com

### GERMANY

Schanzenstraße 36, Geb. 234B  
51063 Cologne  
Phone +49 221 130649 60  
office.de@weverducre.com  
  
Maybachstraße 10  
70469 Stuttgart  
Phone +49 711 806075 90  
office.de@weverducre.com

### ITALY

Via Monte Popera 4/2  
30027 San Donà di Piave - Venezia  
Phone +39 0421 177 83 88  
office.it@weverducre.com

### SWEDEN

Hårdvallsgatan 18  
115 46 Stockholm  
Phone +46 73 045 76 39  
office.se@weverducre.com

### SPAIN

Plaça Duc de Medinaceli 5  
08002 Barcelona  
Phone +34 93 5112 189  
office.es@weverducre.com

### UK

477-478 Batemans Row  
London, EC2A 3HH  
Phone +44 203 174 01 77  
info.uk@weverducre.com

### POLAND

Diamond Business Park  
Posag 7 Panien Street no 1  
02-495 Warsaw  
Phone +48 730 330 358  
office.pl@weverducre.com

# 2nd edition, May 2024

All prices are non-binding recommended prices excluding VAT, lamps (bulbs) are not included. The prices and terms of payment stated in our order confirmation shall apply. To all prices and all extra expenses, we add the legally applicable value added taxes. Should our costs increase by the time of delivery, the prices can be recalculated on a pro rata basis. The prices stated shall apply net ex works. Information on availability as well as delivery terms and dates are provided as a point of reference only and are not binding. Prices are valid till the publication of a new price list. We expressly reserve the right to make changes in price, measurements and design. The details provided in this catalogue were correct at the time of publication. They do not constitute any kind of obligation on our part and are for information only. We shall not be held liable for any discrepancies between the illustrations or descriptions given and the actual product neither for any misprints and/or typing errors. We reserve the right to make alterations or modifications to our products at any time. All mentioned RAL codes are indicative and approximative. We shall not be held liable for any discrepancies which may occur. All mentioned lumen, beam angles, lifetime and SDCM values refer to white luminaires (in terms of finishing, covers or housings) in 3000K. Further values on request. The general terms and conditions of Wever & Ducré BV shall apply to all purchases and orders. The applicable version of the general terms and conditions can be viewed at [weverducre.com/en/downloads](http://weverducre.com/en/downloads).

What's that? A whole new product range, and already several project references? See it this way: Inspiration is key to success in design, so what we care for most is inspiring you and showing you the potential of what we at Wever & Ducré do. Thus, we took the liberty of editing some (original) images to give you an impression of how our luminaires improve living, office, outdoor, and other spaces. These pictures are marked with a 

## ARTWORK

### GRAPHIC DESIGN

### PRINT PRODUCTION

### ILLUSTRATION

### TEXT

### LITHOGRAPHY

### PROJECT MANAGEMENT

### PRINTING

### PHOTOGRAPHY

Zoie Lam, Hong Kong, China

Carola Friedrich, Carina Erlach

Carola Friedrich, René Zavadilík

Carina Erlach, Lukas Hoehenwarter

Tanja Petschnig

Volker Waldhauser

Carola Friedrich, Victoria Prath

Drukarnia Perfekt S.A., Warsaw, Poland

- Apresvino - (456-457), Alvaro Valdecantos (652, 794), @nina Struve for VRAI interior architecture (418), @nomadic\_den (24, 126, 444), @stella (8, 11, 12, 14, 15, 18, 19, 21, 26, 27), Aikon-Producties-bvba (170), Aleksandr Dal Cero (190-191), Alexander Maria Lohmann (188), Andrea Badrutt Fotografie (286), Andrei Valeriu Radulescu (178), Anja Zalezina (488), Annelies Degroote (206), Architekturfotografie Oliver Hallwirth (490), Arnold Ory (60), Barbara Corsico (480), Ben Kwanten (24), Benni Janzen (476-477), Bert Demasure (376), Biderbost Photo (24), Bob Reijnders (120, 318), Capture Photography (118), Catherine Roider (24, 356, 424), Chang Sung Wah (1), Charlotte Kap (164), Chris Snook (92), Christian Brandstätter (706), Christian Jungwirth (40), Christian Repnik (800), Christoph Steinbauer (336, 502, 678, 684, 744), COLORNET-WORK® (20), Corinna Unterkofler/Joachim Grubelnik (736, 782), Dani Rovira Fotografia (802), Daniel Stauch (306), Davide Perbellini (266), Denise Zwijnen Photography (24, 222), Edgar Navarre (536), Elia Kuhn Photographie (72), Erich Sinzinger, 2019 (78, 776), Erik Đuriš (582-583), Evgenij Avramenko (540), Flare Department (24, 34), Gerald Van Rafelghem (750), Hanne Joosen Fotografie (180, 182), Hannelore Veelaert (610), In-Between Architects Limited (620), Ingo Rasp Photography (500), ISTHME Architecture & Urbanisme (76), Jan Kan (646), Jaro van Meerten - The Art of Living magazine (102, 354), Joachim Grothus/Herford/Germany (218), Jurrit van der Waal - The Art of Living magazine (534), Karsten Knocke (664), Kim Donggyu (390), Kris Dekeijser (24, 28, 38, 41, 42, 56, 62, 64, 66, 70, 80, 86, 96, 98, 100, 106, 122, 130, 136, 140, 144, 148, 150, 152, 158, 168, 172, 176, 184, 186, 192, 196, 202, 216, 246, 260, 272, 276, 282, 284, 288, 302, 308, 310, 320, 332, 334-335, 342, 350, 365-366, 392-393, 396, 408, 412, 420, 422, 426, 428, 436, 438, 440-441, 442, 448-449, 452-453, 468, 470, 472-473, 474, 478, 482, 486, 492, 506, 508, 532, 550, 560, 572, 576, 578-579, 580, 616, 636, 654, 656, 670, 672, 682, 686, 688, 694, 698, 702, 708, 716, 718, 728, 738, 742, 752, 754, 758, 760, 768, 778-779, 784, 786, 790, 798), Kris Dimitriadis/Kurt Dekeyzer studio PSG (552) Kurt Kuball (586, 692, 712, 730), Lennart Wiedemuth (460) Luc Roymans (466), Lukas Jahn (704) Margriet Hoekstra (194, 746), Mark Drotsky Architekturfotografie (618-619), Martin Grobe (558, 564-565) Matteo Michelino (24, 450), MattiaAquila (174), Maxi Conesa (240), Melvin Wong Weije (722), Miloš Martinović (9, 45, 134, 608), Miquel Llonch (11), Miriam Raneburger (696), Namsun Lee (208-209), Neil Sharp (504), nunofoto.com (720), Paloma Pacheco Turnes (24, 406, 602-603), Patricia Goijens (446), Paul Karalius (734), Paul Ott (10, 494-495), Paula Beetlestone (726), Petri Immonen (210), Philip Kottlorz Fotografie (274, 340, 566), Pilar Shoots (228-229), Pro Urban AG (430), Rupert Asanger (462), Salvatore Guido (22, 23, 37, 44, 112, 146, 204, 212, 214, 226, 234, 236, 238-239, 262, 264, 268, 270, 280, 304, 312, 314, 316, 328, 338, 352, 360, 378-379, 382, 398, 400, 412, 432, 434, 498, 514, 516, 518, 520, 524, 542, 554, 556, 562, 568, 570, 588, 590, 592, 594-595, 596, 598, 606, 612, 626, 638, 648, 650, 660, 662), SCHWARZ-LICHT / fotografie + kommunikation (404), Sergey Bezuglov (104), Sergio Camplone (128, 464), Søren Kristensen (142), Space content Studio (574-575), Stijn Poelstra (544, 600), Studio Ciao (394), Studio Erick Saillet (84), Studio Gataric Fotografie (640), Sue Baer (416), Supereal.LU (242, 244-245), Tom Ferguson Photography (454), Tom Lierman photography (322) Trien Byttebier, Uliana Grishina Interior and Architectural Photographer @uliana.grishinaa (604), Victor Sajara Photography (774), Walters Media (546), Zvonimir Mihaljek (714)

# Index by name

1-PHASE TRACKS	331
3-PHASE TRACKS	349
BENTO	555
BISHOP	455
BLAS CEILING SURFACE	697
BLAS WALL SURFACE	743
BLIEK PETIT CEILING RECESSED	123
BLIEK PETIT CEILING SURFACE	235
BLIEK ROUND	127
BLIEK SQUARE	129
BLINK	753

## BOX

BOX CEILING SURFACE	169
BOX CEILING SURFACE EXTERIOR	695
BOX MINI CEILING SURFACE	165
BOX MINI WALL SURFACE	533
BOX ON STREX	311
BOX WALL SURFACE	535
BOX WALL SURFACE EXTERIOR	733

CARD	751
------	-----

## CENO

CENO CEILING RECESSED	119
CENO CEILING SURFACE	227
CENO FORT ON 3-PHASE TRACK	353
CENO ON STREX	303
CENO WALL SURFACE	513

CENTRAL	551
CENTRAL EXTERIOR	727
CHART	761
CHART ASYM	763
CITY IP44	159

## CLEA

CLEA CEILING SURFACE	271
CLEA CEILING SUSPENDED	483
CLEA MULTI	483
CLEA WALL SURFACE	571

CONE	403
CORK	405
COSTA	801
DARF CEILING SUSPENDED	391
DARF WALL SURFACE	559

## DEEP

DEEP	65
DEEP ADJUST	71
DEEP ADJUST ASYM	77
DEEP ADJUST FORT	79
DEEP ADJUST PETIT	69
DEEP ADJUST PETIT TRIMLESS	69
DEEP ADJUST TRIMLESS	75
DEEP BIJOU	61
DEEP BIJOU IP65	137
DEEP BIJOU IP65 EXTERIOR	671
DEEPER	67
DEEPER IP44	143
DEEP IP44   IP65	141
DEEP IP65 EXTERIOR	675
DEEP PETIT	63
DEEP PETIT IP65	139
DEEP PETIT IP65 EXTERIOR	673
DEEP POINT	59
DEEP POINT IP44	135

## DINOR

DINOR	493
-------	-----

## DOCUS

DOCUS CEILING SURFACE	175
DOCUS MINI CEILING SURFACE	173
DOCUS MINI WALL SURFACE	539
DOCUS ON STREX	313

## DOMINO

## DRO

DRO CEILING SURFACE	263
DRO CEILING SUSPENDED	413
DRO FLOOR SURFACE	661
DRO ON 1-PHASE TRACK	341
DRO TABLE	649
DRO TABLE   FLOOR SURFACE	647
DRO WALL SURFACE	557

ELLO CEILING SUSPENDED	395
ELLO SYSTEM	362

## FIL

FIL CEILING SUSPENDED	383
FIL SPIN CEILING SURFACE	251
FIL SPIN WALL SURFACE	615

FINELLE CEILING SUSPENDED	381
---------------------------	-----

## FINLIN

FINLIN ROUND	613
FINLIN SURFACE	277
FINLIN SUSPENDED	385
FINLIN WALL	609
FINLIN FLOOR SURFACE	657

GATE FLOOR SURFACE EXTERIOR	789
GEO FLOOR SURFACE EXTERIOR	769
GIGANT	397

## HEXO

HEXO CEILING SURFACE	181
HEXO CEILING SUSPENDED	471
HEXO MINI CEILING SURFACE	179
HEXO MINI WALL SURFACE	541
HEXO MULTI	471
HEXO ON 1-PHASE TRACK	343
HEXO ON 3-PHASE TRACK	355
HEXO ON STREX	315

ILANE	367
INTRA	679

## J.J.W.

J.J.W. CEILING SURFACE	273
J.J.W. CEILING SUSPENDED	437
J.J.W. WALL SURFACE	573

KIOSK WALL SURFACE EXTERIOR	725
KIOSK FLOOR SURFACE EXTERIOR	775

KUJO CEILING SUSPENDED	387
LECA CEILING RECESSED	109
LECA CEILING SURFACE	221
LEENS	553
LINUS	799
LITO	501
LUNA ROUND IP44	151
LUNA SQUARE IP44	151
MAP	755
MAP ASYM	759

## MATCH

MATCH CEILING RECESSED	113
MATCH CEILING SURFACE	223
MATCH CEILING SUSPENDED	407
MATCH POINT	57
MATCH POINT IP44	57
MATCH SNOOZE	623
MATCH STICK	117
MATCH SURFACE ON STREX	307
MATCH SUSPENDED ON STREX	321
MATCH WALL	515
MATCH FLOOR SURFACE	659

## MICK

MICK CEILING SURFACE	237
MICK ON STREX	309
MICK SNOOZE	625
MICK WALL SURFACE	627

MILES	601
MIRBA IP44	641

# Index by name

## MIRBI

MIRBI IP44 CEILING RECESSED	157
MIRBI IP44 CEILING SURFACE	283
MIRBI LONG IP44	643

## MIRRO

MIRRO CEILING SURFACE	267
MIRRO CEILING SUSPENDED	431
MIRRO FLOOR SURFACE	663
MIRRO TABLE	651
MIRRO WALL SURFACE	581
MIRRO SOFT CEILING SURFACE	269
MIRRO SOFT CEILING SUSPENDED	433
MIRRO SOFT WALL SURFACE	585

NET	377
-----	-----

## ODREY

ODREY CEILING SUSPENDED	461
ODREY MULTI	461
ODREY ON 1-PHASE TRACK	345
ODREY ON STREX	323
ODREY WALL SURFACE	525

ORIS	509
ORIS EXTERIOR	707
PALOS WALL SURFACE EXTERIOR	741
PALOS CARRÉ FLOOR SURFACE EXTERIOR	795
PALOS ROUND FLOOR SURFACE EXTERIOR	791

# Index by name

## PERLEZ

PERLEZ IP44 CEILING RECESSED	155
PERLEZ IP44 CEILING SURFACE	279
PERLEZ SPIN	255
PERLEZ GRID	259
PERLEZ IP44 WALL SURFACE	635

## PIRRO

PIRRO CEILING RECESSED	93
PIRRO ON 1-PHASE TRACK	339
PIRRO OPAL	211
PIRRO PETIT CEILING RECESSED	91
PIRRO PETIT CEILING SURFACE	203
PIRRO SPOT CEILING SURFACE	205
PIRRO SYSTEM	361

PLANO PETIT CEILING RECESSED	97
PLANO CEILING RECESSED	99
PLANO IP44 CEILING RECESSED	153
PLANO PETIT CEILING SURFACE	213
PLANO CEILING SURFACE	215
POLA FLOOR SURFACE EXTERIOR	773

## RAY

RAY CEILING SURFACE	189
RAY CEILING SURFACE EXTERIOR	689
RAY CEILING SUSPENDED	469
RAY MINI CEILING SURFACE	185
RAY MINI WALL SURFACE	543
RAY MULTI	469
RAY ON 1-PHASE TRACK	343
RAY ON 3-PHASE TRACK	355
RAY ON STREX	317
RAY WALL SURFACE	545
RAY WALL SURFACE EXTERIOR	721

REED FLOOR SURFACE EXTERIOR	771
RETO WALL RECESSED	499
RETO WALL RECESSED EXTERIOR	703
RETO WALL SURFACE EXTERIOR	739
REVER DINING	655
RINI SNEAK IP44	149
ROB EXTERIOR	699
ROB IP44	285
ROBY IP44	287
RONY	85
RONY POINT	83
RON	87

## ROOMOR

ROOMOR SUSPENDED	445
ROOMOR FLOOR SURFACE	665
ROOMOR OFFICE CABLE SUSPENDED	451
ROOMOR OFFICE CEILING SURFACE	275
ROOMOR OFFICE ON TRACK	357
ROOMOR TABLE	653
ROOMOR WALL SURFACE	561

RUVI CEILING RECESSED	131
RUVI IP44 WALL SURFACE	639

## SARA

SARA ON 1-PHASE TRACK	333
SARA ON BASE	241
SARA SNOOZE	621

SCAVA	631
SHIEK	487
SHIEK MULTI	487

SIRRO	217
SNEAK	105
SNEAK TRIMLESS	107
SOLID BIJOU	193
SOLID	197
SOLID PETIT	195
SOLLI ON STREX	329
SOLLI	409
SOLLI COCOON	411
SPINEO	81
SQUBE ON BASE	243
SQUBE ON 1-PHASE TRACK	337
SQUBE ON 3-PHASE TRACK	351
STAKE	785
STAKE FOLD	785
STIPO EXTERIOR	783
STRANGE CEILING RECESSED	103
STRANGE PETIT TRIMLESS	101
STRANGE TRIMLESS WALL RECESSED	505
STREX MODULE   DOT	319
STREX MODULE   OPAL	319
STREX SYSTEM   48V	294
STRIPE	503
SWAM FLOOR SURFACE	777
SWAM WALL SURFACE	747

## TAIO

TAIO CEILING RECESSED EXTERIOR	677
TAIO CEILING SURFACE EXTERIOR	687
TAIO IP65 CEILING RECESSED	147
TAIO IP65 CEILING SURFACE	281
TAIO WALL SURFACE EXTERIOR	719

TAPE FLOOR SURFACE	781
TAPE WALL SURFACE	745
TAPIS	591
TAPIS SOFT	597
THEMIS	507
TOWNA IP44	289

# Index by name

## TRACE

TRACE CEILING SURFACE	201
TRACE CEILING SUSPENDED	399
TRACE CHANDELIER	373
TRACE SPIN	253
TRACE GRID	257
TRACE SLIM	521
TRACE WALL	517

## TRAIN

TRAIN	549
TRAIN CEILING SURFACE EXTERIOR	691
TRAIN WALL SURFACE EXTERIOR	723

TRAM CEILING SURFACE EXTERIOR	683
TRAM WALL SURFACE EXTERIOR	713
TUBE CARRÉ CEILING SURFACE EXTERIOR	693
TUBE CARRÉ WALL SURFACE EXTERIOR	729
TUBE CEILING SURFACE EXTERIOR	685
TUBE WALL SURFACE EXTERIOR	715
VENN CEILING SURFACE	261
VENN WALL SURFACE	617
WETRO	475
WETRO MULTI	475

## WIRO

WIRO CEILING SURFACE	265
WIRO CEILING SUSPENDED	417
WIRO CONE	417
WIRO DIAMOND	423
WIRO GLOBE	427
WIRO WALL SURFACE	569

X-BEAM WALL SURFACE	737
X-BEAM FLOOR PROJECTOR	787

IT'S A MATERIAL WORLD

# Colours and materials



For specific information on colour and finishes please refer to [weverducre.com/materials](https://weverducre.com/materials)

Depending on the product and application, the materialization may differ. For more informations on materials, finishes, structures, RAL and NCS colour codes, please check our product page on the website. RAL and NCS colour codes are always approximate and can be checked by the customer based on samples.

## Outdoor

### METAL

	<b>W</b>	White
	<b>D</b>	Grey
	<b>A</b>	Anthracite Grey
	<b>Q</b>	Bronze
	<b>G</b>	Gold
	<b>B</b>	Black
	<b>K</b>	Black and Gold

	<b>I</b>	Inox   304 Stainless steel electro polished
--	----------	---

### POLYPROPYLENE

	<b>YE</b>	White and Colza Yellow
	<b>OR</b>	White and Traffic Orange
	<b>SB</b>	White and Water Blue
	<b>OB</b>	White and Black

## Indoor

### RECYCLED PET FELT

	<b>WF</b>	White
	<b>MF</b>	Marble Grey
	<b>LF</b>	Limestone
	<b>OF</b>	Oxide Red
	<b>IF</b>	Indigo Blue
	<b>AF</b>	Anthracite
	<b>F</b>	Grey

### ALUMINIUM COMPOSITE MATERIAL

	<b>GB</b>	Black and Light Gold
	<b>NB</b>	Black and Black Chrome
	<b>LB</b>	Black and Glossy Aluminium

### MARBLE

	<b>MB</b>	Black
	<b>MW</b>	White

### GLASS HANDBLOWN

	<b>TS</b>	Smoked Striped
	<b>TW</b>	Taupe White
	<b>DW</b>	Dark Taupe White
	<b>TD</b>	Smoked Diamond
	<b>FD</b>	Frosted Diamond   Opal
	<b>P</b>	Copper Plated
	<b>B</b>	Smoked
	<b>W</b>	White   Opal

### PLASTER

	<b>GW</b>	Give Warmth
	<b>ST</b>	Stay Together
	<b>RA</b>	Raw material for custom paint
	<b>FJ</b>	Feel Jade

### METAL

	<b>E</b>	White and Black
	<b>J</b>	White and Gold
	<b>WM</b>	White and Champagne
	<b>GB</b>	Gold and Black
	<b>H</b>	Champagne and Black
	<b>K</b>	Black and Gold
	<b>CH</b>	Black and Champagne
	<b>BQ</b>	Black and Bronze
	<b>Z</b>	Black and Copper
	<b>BL</b>	Black and Aluminium
	<b>GW</b>	Cement Grey and White
	<b>RR</b>	Coral Red and White

### OTHERS

	<b>W</b>	White   LLDPE
	<b>D</b>	Grey Texture Composite material

### METAL

	<b>W</b>	White
	<b>S</b>	Silver
	<b>L</b>	Aluminium
	<b>G</b>	Gold
	<b>M</b>	Champagne
	<b>Q</b>	Bronze
	<b>P</b>	Copper
	<b>V</b>	Rust
	<b>B</b>	Black
	<b>A</b>	Anodised Aluminium
	<b>LS</b>	Live Simple
	<b>SG</b>	Silk Grey
	<b>FJ</b>	Feel Jade
	<b>CC</b>	Come Closer



4  
5  
8  
7  
6

WYAM